

**QST**

devoted entirely to

# amateur radio



april  
1934  
25 cents



# PRICELESS

ALLEN D. CARDWELL, MFG., CORP.  
Brooklyn, N. Y.

Att: Mr. Frank E. Etzel:

Dear Sir:

I wish to acknowledge receipt of two insulators for Cardwell Condenser 164 B, for which I highly appreciate your sending, especially the quick service you have given me. I am enclosing 20¢ in stamps as per your request.

I might say that I have used Cardwell condensers ever since I first became interested in radio especially in "ham" radio, and have never found their equal. I have in my possession a Cardwell receiving condenser, the first I ever bought, which was I believe in 1924, this condenser has been used in several receivers and at present is used to tune a double stage in my xtal transmitter and is still going strong, I doubt if it will ever reach the point where I shall be forced to obtain a new one in its place.

In these days of cut-throat competition, especially in the radio field, it is gratifying to deal with a firm that stand behind their product, and really knows the meaning of a satisfied customer, through their fine service.

Again I thank you for your courtesy,

Very truly yours,

*We take pride in reproducing the above unsolicited testimonial. The name of the sender is available upon request*

*Any reliable supplier should cooperate with you to enable you to get what you want. He can get CARDWELLS for you if he does not keep them in stock. Get what you want — insist on CARDWELLS. Order direct from us if your dealer will not supply you, or let us tell you where you may buy.*

**The ALLEN D. CARDWELL MFG. CORP'N.**  
83 PROSPECT STREET, BROOKLYN, N. Y.

**"THE STANDARD OF COMPARISON"**

Say You Saw It in QST — It Identifies You and Helps QST

**PRICELESS** — to us are the good will and confidence of a generation of **CARDWELL** users — Amateurs — Engineers and Experimenters. Of significance to you, too, if not now a **CARDWELL** user because with **CARDWELLS** you may be assured of lasting satisfaction and the utmost in efficiency.

Many of the latest developments have been built around **CARDWELL** condensers — there's a **CARDWELL** for every tube, purpose and pocketbook.

*Send for literature*



CARDWELL "TRIM-AIR" MIDGET CONDENSERS  
CARDWELL MIDWAY "FEATHERWEIGHT" CONDENSERS,  
RECEIVING and TRANSMITTING

CARDWELL "STANDARD" MODELS FOR RECEIVERS  
and MEDIUM POWER TRANSMITTERS

CARDWELL 16-B TRANSMITTING CONDENSERS  
FOR LARGER TRANSMITTERS

CARDWELL HIGH VOLTAGE CONDENSERS  
FOR COMMERCIAL RADIO-TELEGRAPH and  
BROADCASTING STATIONS

CARDWELL S-2244 OIL DIELECTRIC FIXED CONDENSERS  
FOR HIGH FREQUENCY FURNACES  
and TUBE BOMBARDERS

THERE'S A **CARDWELL** FOR EVERY TUBE,  
PURPOSE and POCKETBOOK

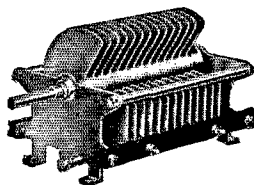

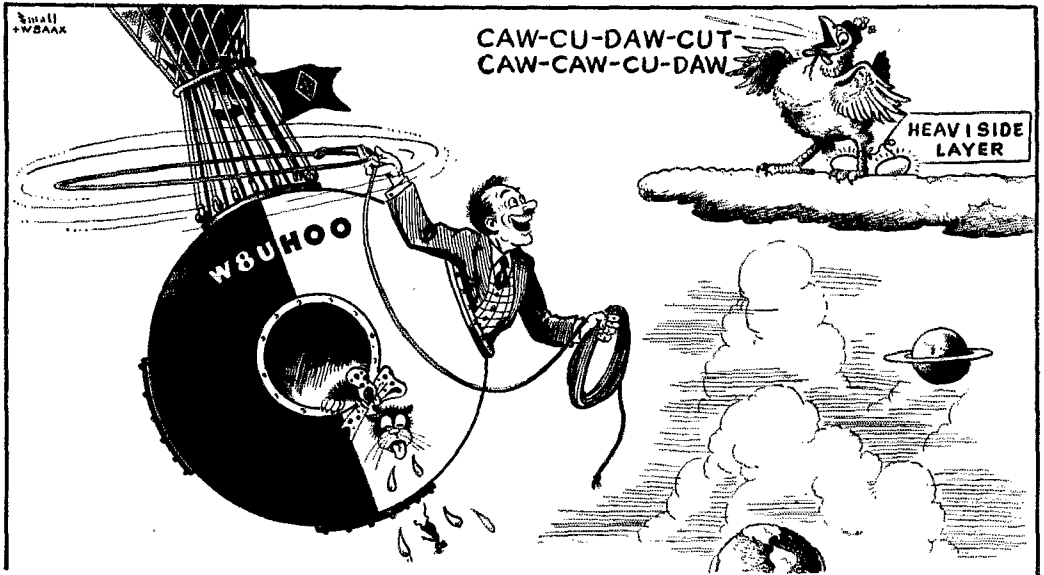

## Bring the Heaviside Layer down to earth with *Westinghouse Instruments*

**D**ON'T let the Heaviside Layer float around in space playing pranks with your sigs. Get it down out of the clouds and put it to work, bouncing your X-missions back to where you want them.

Directional effects of the radiating system, dead spots on your DX map, probably result from some unlooked-for interference patterns in your field form. The direction of your maximum field may result in poking your sigs through the Heaviside Layer where they wander through space to show up eventually as sun spots.

Your radiating system should give you uniform radiation in all directions, for maximum results; or else should be designed for a controllable directional effect. In either case, to assure proper operation, you'll want the latest Westinghouse folder on "The Angle of Radiation" which will help you take full advantage of the action of the Heaviside Layer.

Briefly, it gives: A general discussion on fields surrounding an antenna; effect of horizontally-polarized waves; effect of vertically

polarized waves; engineering opinions on effects of polarization and angle of radiation elevation; dope on complicated arrays used by commercials, and reasons for them; and some additional information on feeder lines.

The radiating system is the most important part of the amateur station. This new booklet and the one announced last month should help the ham locate faults in his present system, and provide many ideas for improvement. They give very complete information regarding directional antennae for frequencies of 14 mc. and greater. Send for your copies.

You'll need good instruments to assure proper operation of your radiating system, and the entire rig. Westinghouse types MX and NX will give you accurate results and long service. Sold at standard prices, they make your money go farther because of their many improvements over conventionally designed instruments. Check the coupon for Catalog 43-340 which describes and lists them.

### SEND FOR INFORMATION

Westinghouse Electric & Manufacturing Company  
Dept. 125, Room 2-N East Pittsburgh, Pa.

Gentlemen: Please send the booklets checked below:

- F. 8329—The Angle of Radiation  
 F. 8327—Directional Antennae  
 Catalog 43-340—Types MX and NX Instruments.

Name .....  
 Address .....  
 City.....State..... T 79942  
 Call Letters..... QST 4-34

# Westinghouse

Since 1888, Manufacturers of highest quality instruments which are now available at standard prices. There is no longer any reason for accepting lower standards.  
 Good territory is still open for dealers.





# QST

Published monthly, as its official organ, by the American Radio Relay League, Inc., at West Hartford, Conn., U. S. A.; Official Organ of the International Amateur Radio Union

devoted entirely to

## AMATEUR RADIO

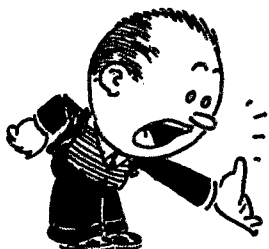

Editorials . . . . .	9
A Special QST for May . . . . .	10
Further Notes on Regulations . . . . .	10
A Single-Tube High-Frequency Converter . . . . . <i>Clark C. Rodimon</i>	11
The Operation of R. F. Power Amplifiers . . . . . <i>Part II H. A. Robinson, W3LW</i>	14
Announcing — The A.R.R.L. "20th Anniversary Relay" . . . . .	19
New England Division Convention . . . . .	20
Iowa State Convention . . . . .	20
More on Overmodulation . . . . .	21
Adding to the Single-Tube Transmitter . . . . . <i>George Grammer</i>	22
A Simple Cathode-Ray Oscilloscope . . . . . <i>James Millen, W1HRX and Dana H. Bacon, W1BZR</i>	27
Improving the Freqmeter-Monitor . . . . . <i>D. A. Griffin, W2AOE</i>	31
Hamdom . . . . .	33
Amateurs of Assistance in Emergencies . . . . .	34
How to Get Those Foreign QSL's . . . . .	36
Master Control Station "NDM" . . . . . <i>Lt.-Commander E. C. Rogers</i>	37
Experimenters' Section . . . . .	39
IMPROVING THE PERFORMANCE OF THE VOLTAGE FED HERTZ — TAPPED-COIL DETECTOR WITH FILAMENT-TYPE TUBES — INCREASING I. F. SELECTIVITY BY REGENERATION — ON THE PENTAGRID SUPERHET	
Amateur Radio Stations . . . . . <i>W3BEI, W7BB, VE2HM</i>	41
I. A. R. U. News . . . . .	43
Communications Department . . . . .	45
Correspondence Department . . . . .	62
Financial Statement . . . . .	70
Standard Frequency Transmissions . . . . .	72
Joint Meeting I.R.E.-U.R.S.I. . . . .	72
New Attenuator Control . . . . .	76
The Oklahoma State Convention . . . . .	86
Hamads . . . . .	90
QST's Index of Advertisers . . . . .	94

APRIL  
1934

VOLUME XVIII  
NUMBER 4

**Kenneth B. Warner (Secretary, A.R.R.L.), Editor-in-Chief and Business Manager; Ross A. Hull, Associate Editor; James J. Lamb, Technical Editor; George Grammer, Assistant Technical Editor; Clark C. Rodimon, Managing Editor; David H. Houghton, Circulation Manager; F. Cheyney Beekley, Advertising Manager; Ursula M. Chamberlain, Assistant Advertising Manager.**

**Editorial and Advertising Offices**  
33 La Salle Road, West Hartford, Conn.

Subscription rate in United States and Possessions and Canada, \$2.50 per year, postpaid; all other countries, \$3.00 per year, postpaid. Single copies, 25 cents. Foreign remittances should be by international postal or express money order or bank draft negotiable in the U. S. and for an equivalent amount in U. S. funds.

Entered as second-class matter May 29, 1919, at the post office at Hartford, Connecticut, under the Act of March 3, 1879. Acceptance for mailing at special rate of postage provided for in section 1103, Act of October 3, 1917, authorized September 9, 1922. Additional entry at Concord, N. H., authorized February 21, 1929, under the Act of February 28, 1925.

Copyright 1934 by the American Radio Relay League, Inc.  
Title registered at United States Patent Office.

# Aristocrats of the RADIO FAMILY

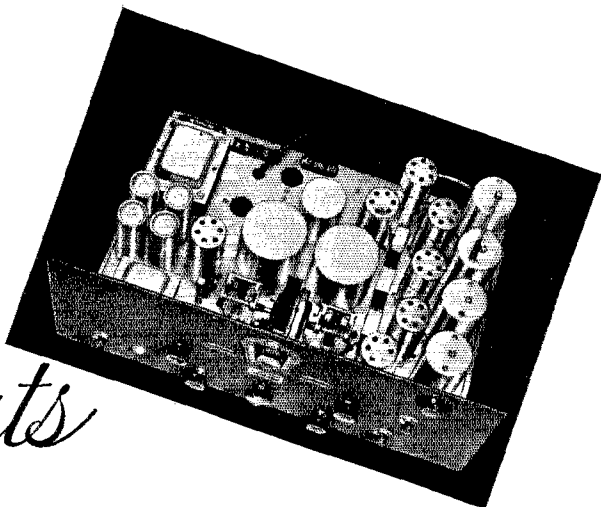

COMET "PRO" chassis with Crystal Filter and A.V.C. Supplied also in metal table cabinet or "Moderno" console.

**H**UNDREDS of COMET "PRO" Receivers are in daily use by amateurs. Leading professional operators, air transport and steamship lines, broadcasting networks and armies and navies all over the world chose the "PRO" after the most exhaustive tests.

There could be no finer testimonial to the extraordinary sensitivity, selectivity and all-around performance of this really great receiver.

Don't be misled by wild claims or price ballyhoo. You want the most efficient receiver that money can buy — and you want it at the right price. We guarantee that the COMET "PRO" 8-to-550-meter Superheterodyne will satisfy your every requirement or money refunded.

**4 models**

- STANDARD
- STANDARD + A.V.C.
- CRYSTAL
- CRYSTAL + A.V.C.

Operating on Battery, D.C., or A.C. in all Voltages and Cycles

## New TRANSMITTER CHOKE

This transmitter choke gives you more than 500,000 ohms of impedance exactly where wanted — at the 20, 40, 80 and 160-meter amateur bands.

Inductance 2.5 mh. Distributed capacity less than 1.5 mmf. D.C. resistance 8 ohms. Maximum recommended D.C. (continuous) 500 milliamperes. Six universal-wound pies on Isolantite core. Insulated mounting brackets secured by short machine screws. No metal through core. Without brackets, may be mounted with single machine screw. Choke size: 1 3/16" x 2 3/4".

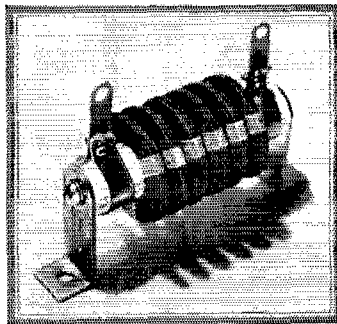

## New MIDGET R. F. CHOKE

Ideal for small space and where economy is a factor.

Five universal-wound pies on Isolantite core. Inductance 2.1 mh. D.C. resistance 35 ohms. Distributed capacity 1 mmf. Length across caps 1 1/2". Diameter 1/2". Current 125 milliamperes.



Mail Coupon for Details



HAMMARLUND MANUFACTURING CO.  
424-438 W. 33rd St., New York

... Check here for information on new Choke Coils. ... Check here for complete 1934 Catalog of Precision Radio Parts. ... Check here for new booklet on COMET "PRO" Receiver with Quartz Crystal Filter and Automatic Volume Control.

Name .....

Address .....

.....Q-4

For Better Radio  
**Hammarlund**  
PRECISION  
PRODUCTS

## Section Communications Managers of the A.R.R.L. Communications Department

All appointments in the League's field organization are made by the proper S.C.M., elected by members in each Section listed. Mail your S.C.M. (on the 16th of each month) a postal covering your radio activities for the previous 30 days. Tell him your DX, plans for experimenting, results in 'phone and traffic. He is interested, whether you are an A.R.R.L. member or get your QST at the newstands; he wants a report from every active ham. If interested and qualified for O.R.S., O.P.S. or other appointments he can tell you about them, too.

Eastern Pennsylvania	W3GS	<b>ATLANTIC DIVISION</b> Jack Wagenseller	24 South Fairview Ave.	Highland Park, Upper Darby
Maryland-Delaware-District of Columbia	W3BAK	Edgar L. Hudson		Laurel, Delaware
Southern New Jersey	W3QL	Gedney Rigor	412 2nd Ave.	Haddon Heights
Western New York	W8DSP	Don Farrell	213 Hickock Ave.	Syracuse
Western Pennsylvania	W8CUG	C. H. Grossarth	R. F. D. 3, Eicher Rd.	Emsworth, Bellevue, Pa.
Illinois	W9WR	<b>CENTRAL DIVISION</b> Fred J. Hinds	6618 West 34th St.	Berwyn
Indiana	W9TE	Arthur L. Braun	911 Reisner St.	Indianapolis
Kentucky	W9OX	Carl L. Plum	P. O. Box 359	Louisville
Michigan	W8DYH	Kenneth F. Conroy	7538 E. Robinwood Ave.	Detroit
Ohio	W8BAH	Harry A. Tummonds	2073 West 85th St.	Cleveland
Wisconsin	W9FSS	Harold H. Kurth	2550 N. 8th St.	Milwaukee
North Dakota	W9DGS-IFW	<b>DAKOTA DIVISION</b> Wm. Langer	313 First Ave., S.	Jamestown
South Dakota*	W9AZR	Cecil B. Davis		Jripp
Northern Minnesota	W9TIE	Robert C. Harshberger	1200 Fauquier St.	St. Paul
Southern Minnesota*	W9DEI	Francis C. Kramer	W. Bluff St.	St. Charles
Arkansas	W5ABI	<b>DELTA DIVISION</b> H. E. Velte	2918 West 15th St.	Little Rock
Louisiana	W5DWW	W. J. Wilkinson, Jr.	1624 Allen Ave.	Shreveport
Mississippi*	W5VJ	W. P. Allen	P. O. Box 60	Jackson
Tennessee	W4AFM	F. F. Purdy	P. O. Box 173	Kingsport
Eastern New York	W2LU	<b>HUDSON DIVISION</b> Robert E. Haight	1080 Helderberg Ave.	Schenectady
N. Y., C. & Long Island	W2AZV	E. L. Baunach	7823 10th Ave.	Brooklyn
Northern New Jersey*	W2BPY	Robert Maloney	315 Watson Ave.	Perth Amboy
Iowa	W9FFD	<b>MIDWEST DIVISION</b> George D. Hansen	3734 Summit St.	Sioux City
Kansas	W9FLG	O. J. Spetter	305 Western Ave.	Topeka
Missouri	W9EYG-JPT	C. R. Cannady	300 Sixth St.	Monett
Nebraska	W9FAM	Samuel C. Wallace	Green St.	Clarks
Connecticut	W1CTI	<b>NEW ENGLAND DIVISION</b> Frederick Ellis, Jr.	19 Merrill Rd.	Norwalk
Maine	W1CDX	John W. Singleton	10 High Street	Wilton
Eastern Massachusetts	W1ASI	Joseph A. Millen	16 Mercier Ave.	Ashmont
Western Massachusetts	W1ASY-WIRB	Earl C. Hewinson	63 Cortland St.	Springfield
New Hampshire	W1APK	Basil Cutting		Pembroke
Rhode Island	W1QR	Albert J. King	66 Lisbon St.	Providence
Vermont	W1ATF	Harry Page	R. 1	Hinesburg
Alaska	K7PQ	<b>NORTHWESTERN DIVISION</b> Richard J. Fox	Box 301	Ketchikan
Idaho	W7AVP	Don D. Oberbillig	P. O. Box 1271	Hoise
Montana	W7AA1-7QT	O. W. Viers		Red Lodge
Oregon	W7ABZ	Raymond W. Cummins	4835 N. Amherst St.	Portland
Washington	W7AYO	Stanley J. Belliveau	Route 7, Box 387	Yakima
Hawaii	K6COG	<b>PACIFIC DIVISION</b> C. D. Slaten	Pearl City	Oahu
Nevada	W6EAD	Keston L. Ramsay	1151 Buena Vista Ave.	Reno
Los Angeles	W6AAN	Francis C. Martin	738 W. Huntington Drive	Arcadia
Santa Clara Valley*	W6DBB	Barton A. Wood	R. 1, Box 722	Campbell
East Bay	W6ZY	P. W. DeLay	1321 Chestnut St.	Berkeley
San Francisco	W6CAL	Bryon Goodman	141 Alton Ave.	San Francisco
Sacramento Valley	W6DVE	Geo. L. Woodington	716 Redwood Ave.	North Sacramento
Arizona	W6BJF-W6QC	Ernest Mendoza	1434 East Madison St.	Phoenix
Philippines*	KA1XA	Newton E. Thompson	714 Tennessee	Manila, P. I.
San Diego	W6EOP	Harry A. Ambler	4101 Hamilton St.	San Diego
San Joaquin Valley	W6DZN	G. H. Lavender	Route 6, Box 425	Stockton
North Carolina	W4AVT	<b>ROANOKE DIVISION</b> G. H. Wright, Jr.		Wendell
Virginia	W3AAJ	R. N. Eubank	2817 Montrose Ave.	Richmond
West Virginia	W8HD	C. S. Hoffmann, Jr.	100 20th St.	Warwood, Wheeling
Colorado	W9BTO	<b>ROCKY MOUNTAIN DIVISION</b> T. R. Becker	1176 Gaylord St.	Denver
Utah-Wyoming*	W6GQC-IDM	Arty W. Clark	260 So. 9th West	Salt Lake City, Utah
Alabama	W4KP	<b>SOUTHEASTERN DIVISION</b> L. D. Elwell	1066 Waverly St.	Tarrant
Eastern Florida	W4NN	Ray Atkinson	4524 College St.	Jacksonville
Western Florida	W4MS	Edward J. Collins	1517 East Brainard St.	Pensacola
Georgia-S. Carolina-Cuba- Isle-of-Pines-Porto Rico- Virgin Islands	W4UT	George A. Love	1202 NE Springdale Rd.	Atlanta
Northern Texas	W5AUL	<b>WEST GULF DIVISION</b> Glen E. Talbutt	1902 South 11th St.	Abilene
Oklahoma	W5CEZ	Carter L. Simpson	2010 So. 4th St.	Ponca City
Southern Texas	W5BHO	David H. Calk	6726 Ave. Q	Houston
New Mexico	W5DUI	Dan W. De Lay	407 South Girard St.	Albuquerque
Maritime	VE1DQ	<b>MARITIME DIVISION</b> A. M. Crowell	69 Dublin St.	Halifax, N. S.
Ontario	VE3GT	<b>ONTARIO DIVISION</b> S. B. Fraiser, Jr.	4 Shorncliffe Ave.	Toronto
Quebec*	VE2GA	<b>QUEBEC DIVISION</b> J. A. Robertson	245 Edison Ave.	St. Lambert, P. Q.
Alberta	VE4GD	<b>VANALTA DIVISION</b> J. Smalley, Jr.	611 1st Ave., N. W.	Calgary
British Columbia	VE5AC	R. K. Town	1754 Graveley St.	Vancouver
Manitoba	VE4CG	<b>PRAIRIE DIVISION</b> Reg. Strong	711 Ashburn St.	Winnipeg
Saskatchewan	VE4EL	Wilfred Skatfe	2040 McTavish St.	Regina

\* Officials appointed to act until the membership of the Section choose permanent S.C.M.'s by nomination and election.



NO.	TYPE	WEIGHT	PRICE
<b>CLASS B OUTPUT</b>			
765 B.....	Class B 46's or 59's to 500 ohm line.....	2½ lb.	\$8.00
781 B.....	Class B 830's, 830B's, 800's, 210's, 46's, 59's to 3300-6250 ohm load. Max audio power 70W Max sec. D.C. .150A.....	7 lb.	6.00
783 A.....	Class B 830's, 830B's, 800's, 203A's, 211's to 4000-6000 ohms. Max audio power 170W. Max. sec. D.C. .200A.....	25 lb.	18.00
790 A.....	Class B 203A's, 211's, or Class A 845's to 5000 ohms. Max audio power 250W; Max sec. D.C. .200A.....	35¼ lb.	30.00
791 A.....	Class B 203A's to 2500 or 10,000 ohms. Max audio power 250W; Max sec. D.C. .400A-.200A.....	35¼ lb.	32.00
793 A.....	Same as 791A designed for broadcast station use.....	60 lb.	54.00
794 A.....	Same as 790A designed for broadcast station use.....	60 lb.	54.00
792.....	Class B 204A's or 849's to 4800-5200 ohm load including oil tank.....	90 lb.	96.00
<b>TRANSFORMERS FOR 5 METER TRANSMITTERS AND BATTERY AMPLIFIERS</b>			
740 Z.....	Class B Output 53's, 79's, 19's, 49's to 5000-7000 ohms.....	15 oz.	2.00
741 Z.....	Class B Output 53's, 79's, 19's, 49's to 2500-3000 ohms.....	15 oz.	2.00
742 Z.....	Class B Output 53's, 79's, 19's, 49's to 3-8-12 ohms.....	15 oz.	2.00
750 X.....	Class B Input 19 driven by 30.....	7 oz.	2.00
752 X.....	Class B Input 19 or 49 driven by 31.....	7 oz.	2.00
753 X.....	Class B Input 79 driven by 37.....	7 oz.	2.00
754 X.....	Class B Input 53 driven by 56 or 53.....	7 oz.	2.00
<b>PLATE-FILAMENT TRANSFORMERS</b>			
903 C.....	500-500v 2.5v 2.5v 5v .125A. 4A.CT 3A.....	8 lb.	5.50
905 C.....	500-500v 2.5v 2.5v 5v .175A 4A.CT 3A.....	11¼ lb.	8.00
910 C.....	350-350v 2.5v 2.5v 5v .100A 12.5A.CT 3.5A.CT 2A.....	6 lb.	4.40
911 C.....	325-325v 2.5v 2.5v 5v .060A 4.5A.CT 1.75A.CT 2A.....	3¼ lb.	2.50
<b>PLATE TRANSFORMERS</b>			
912 A.....	920-740-740-920 .250A-.350A. DC v. RMS.....	29¼ lb.	16.50
913 A.....	1500-1240-1240-1500v. .150A-.210A. DC RMS.....	29¼ lb.	16.50
930 A.....	1350-1350v. RMS .400A-.500A. DC.....	35¼ lb.	30.00
Other stock sizes up to 10 KW available. Quotation on request.			
<b>FILAMENT TRANSFORMERS</b>			
	<i>Pri.</i>	<i>Sec.</i>	<i>Insulation</i>
1699 Z.....	110v.	2.5v-4A CT	2500v
1700 Z.....	110v.	6.3v-2A CT	2500v
1022 C.....	110v.	2.5v-10A CT	3500v
1032 C.....	105v	10 or 7.5v-12A CT	
		2.5v-10A CT	5000v
1039 B.....	105v.	10 or 11v-25A CT	3000
1052 A.....	105v.	5v-20A CT	15,000v
1053 A.....	105v.	11v-50A CT	5000v
<b>FILTER CHOKES</b>			
808 C.....	8 hy .300 A. DC. 100 ohms	1500v	9¼ lb. 5.50
809 C.....	20 hy .200 A. DC. 250 ohms	2500v	9¼ lb. 5.50
840 C.....	15 hy .100 A. DC. 210 ohms	1000v	2¼ lb. 2.00
841 C.....	10 hy .150 A. DC. 130 ohms	1000v	3¼ lb. 2.50
842 C.....	8 hy .500 A. DC. 70 ohms	2500v	16 lb. 9.75
Chokes for high power rectifiers available. Quotations on request.			
SWINGING INDUCTANCE: Any of the above chokes can be supplied adjusted for swinging inductance for use as input choke. Add "S" to type No. when ordering, thus: — 842 CS.			
<b>AUDIO CHOKE</b>			
850 C.....	600 hy .005 A. DC.	2000 ohms	4.00

"A" following type number indicates cast frames with pressed steel end plates and porcelain bushed terminals. Black Japan finish. "B" indicates pressed steel case with bakelite terminal boards on sides. Udylite finish. "C" indicates pressed steel case with long insulated leads out base. "Z" indicates open frame with long insulated leads.

Prices are quoted net to eliminate unnecessary computations. New prices shown are effective March 15, 1934. Certain items are priced below previous listings because of increased quantity production. Others are slightly higher to permit more costly construction. Prices subject to change without notice.

New York Office—136 Liberty Street

**CEDAR RAPIDS, IOWA, U.S.A.**

# The American Radio Relay League



• **T**HE AMERICAN RADIO RELAY LEAGUE, INC., is a non-commercial association of radio amateurs, bonded for the promotion of interest in amateur radio communication and experimentation, for the relaying of messages by radio, for the advancement of the radio art and of the public welfare, for the representation of the radio amateur in legislative matters, and for the maintenance of fraternalism and a high standard of conduct.

It is an incorporated association without capital stock, chartered under the laws of Connecticut. Its affairs are governed by a Board of Directors, elected every two years by the general membership. The officers are elected or appointed by the Directors. The League is non-commercial and no one commercially engaged in the manufacture, sale or rental of radio apparatus is eligible to membership on its board.

"Of, by and for the amateur," it numbers within its ranks practically every worth-while amateur in the world and has a history of glorious achievement as the standard-bearer in amateur affairs.

Inquiries regarding membership are solicited. A bona fide interest in amateur radio is the only essential qualification; ownership of a transmitting station and knowledge of the code are not prerequisite. Correspondence should be addressed to the Secretary.

## DIRECTORS

*President*  
HIRAM PERCY MAXIM.....W1AW  
Box 216, Hartford, Conn.

*Vice-President*  
CHARLES H. STEWART.....W3ZS  
St. David's, Pa.

*Canadian General Manager*  
ALEX. REID.....VE2BE  
169 Logan Ave., St. Lambert, P. Q.

*Atlantic Division*  
EUGENE C. WOODRUFF.....W8CMP  
234 W. Fairmount Ave., State College, Pa.

*Central Division*  
LOREN G. WINDOM.....W8GZ-W8ZG  
1375 Franklin Ave. Columbus, Ohio

*Dakota Division*  
CARL L. JABS.....W9BVH  
1822 James St., St. Paul, Minn.

*Delta Division*  
M. M. HILL.....W5EB  
P.O. Box 274, Natchitoches, La.

*Hudson Division*  
BERNARD J. FULD.....W2BEG  
280 Broadway, New York City

*Midwest Division*  
H. W. KERR.....W9DZW-W9GP  
Little Sioux, Iowa

*New England Division*  
G. W. BAILEY.....W1KH  
74 Webster Road, Weston, Mass.

*Northwestern Division*  
RALPH I. GIBBONS.....W7KV-W7BIX  
3134 N. E. 25th Ave., Portland, Ore.

*Pacific Division*  
S. G. CULVER.....W6AN  
2962 Russell St., Berkeley, Calif.

*Roanoke Division*  
H. L. CAVENESS.....W4DW  
State College Station, Raleigh, N. C.

*Rocky Mountain Division*  
RUSSELL I. ANDREWS.....W9AAB  
1867 So. Lafayette St., Denver, Colo.

*Southeastern Division*  
J. C. HAGLER, JR.....W4SS  
2424 McDowell St., Augusta, Ga.

*West Gulf Division*  
FRANK M. CORLETT.....W5ZC  
2515 Catherine St., Dallas, Tex.

## OFFICERS

*President*.....HIRAM PERCY MAXIM, W1AW  
Hartford, Connecticut

*Vice-President*.....CHARLES H. STEWART, W3ZS  
St. David's, Pennsylvania

*Secretary*.....KENNETH B. WARNER, W1EH  
West Hartford, Connecticut

*Treasurer*.....ARTHUR A. HEBERT, W1ES  
West Hartford, Connecticut

*Communications Mgr.*...F. EDWARD HANDY, W1BDI  
West Hartford, Connecticut

*General Counsel*.....PAUL M. SEGAL, W3EEA  
1010 Shoreham Building, Washington, D. C.

Address all general correspondence to the executive headquarters at West Hartford, Connecticut



# THE EDITOR'S MILL

FOR many years there was almost no enforcement of the amateur regulations. Most amateurs realized that these regulations were for our common good and willingly complied; but there were always those who through carelessness, inexperience or perversity failed to comply—and enough of them to detract seriously from the enjoyment of the rest of us. We can remember year after year when our Board of Directors, in its annual examination of amateur problems, would ponder some operating difficulty, only to decide that the situation would well take care of itself if existing regulations were enforced. We remember several occasions when the Board, impelled by these considerations, adopted resolutions calling upon the radio authorities for some adequate enforcement of amateur regulations—simply in our own welfare.

Late last year the Federal Radio Commission commenced a general policing of the high-frequency services, including the amateur service, from ten monitoring stations. Amateurs observed in an apparent violation are now served with a “discrepancy report” requiring them to make an explanation for the Commission’s information. For successive *proved* offenses, increasing penalties are to be meted out. Out-of-band operation and inadequately-filtered plate supply are receiving chief attention.

There is no room to fear that this policing activity constitutes a campaign of persecution. Nobody is “out to get us”. It is only proper that our reasonable regulations be enforced. The complexity of modern radio and the congestion in our bands require that there be uniform compliance. It is but fair to the fellows who have spent money to make their stations comply with reasonable regulations, designed to improve conditions, that others be obliged to meet the same fair standard. We’ll all have a whole lot more pleasure out of operating, and get further with our projects, when we are not jammed by broad interfering signals nor our group-status endangered by general out-of-band trespassing.

The Commission is not going to be hard boiled or too “technical”. There have been a few discrepancy reports sent out of this sort but they have been quickly put to rights. However, and admittedly, it is a service still in its developmental stages and naturally it is yet imperfect. The Commission realizes this as well as we amateurs do, and regards the present methods as subject to change as dictated by experience. In particular we have pointed out to the Commission that their present practice of citing amateurs for violation of the regulation requiring adequately-filtered d.c. plate supply, by observations made at a distance, is not working satisfactorily because too often it confuses amplitude modulation caused by fading effects with actually modulated signals. This question is now receiving the study of the Commission’s engineers. It may take a little time to get all of these details of a new service ironed out but the Commission’s aim is coöperation, not despotism, and there will be no victims of wholesale persecution.

We believe that what amateurs want is fair regulations, properly enforced, and with “the other fellow” obliged to play the game in the same way that we do. That, we are assured, is the whole aim of the Commission’s policy.



WE HAVE mentioned the apparent correlation between weather and radio and the sun-spot cycle of eleven and a fraction years. Every radio amateur of a few years' experience is aware of the slow drift of transmitting conditions, and many an old-timer, noting a gradual return to the conditions of the early days of high-frequency communication, has been reflecting that soon we shall have accumulated observations and experience for a complete cycle.

It would now seem that it is not that simple. This sun-spot period of eleven and a fraction years is for the cycle of activity in just one hemisphere of the sun; thereafter a similar period of activity occurs in the other hemisphere. Recent researches indicate that terrestrial weather is quite definitely correlated with the double sun-spot interval of twenty-three years. Although the two periods are similar, the similarity is sometimes but vague, while there is said to be a remarkable coincidence in recurring conditions in terms of the double interval. There seems to be ample reason to believe that radio operating conditions faithfully follow this curve in their major aspects.

Alas and alack, we fear that we shall now have to wait twelve or thirteen years more before we have a complete set of data on the effect of the solar cycle.

NOW is the time for all good men to communicate with their directors and unburden themselves. That is to say, the annual meeting of the A.R.R.L. Board of Directors is soon to occur. The directors are now engaged in collecting amateur opinion on the problems of the day. Members with suggestions for the betterment of amateur radio are invited to QSO their director.

K.B.W.

## A Special QST for May

*Celebrating A.R.R.L.'s twentieth anniversary, May QST is to be an enlarged and special, de luxe issue. A wealth of modern technical material, in addition to feature articles recalling "the good old days," will make it a real gala number—a worth-while souvenir.*

## Further Notes on License Problems

A problem has confronted former amateurs who have let their operator license expire without renewal and who in the meantime have moved to a new address but who now desire to resume amateur activity. A new operator license can be secured. But the old station license, although of no value because it bears the wrong address, was in the peculiar position of being valid and yet not subject to modification of the address because of a provision in Rule 402.

In its original form Rule 402 provided that station or operator licenses could be renewed or modified only provided certain minimum activity was proved for the three-months period prior to submitting application. Obviously an inactive station was not able to prove use of license, and so was not eligible for modification.

At the intercession of A.R.R.L. the Commission on February 26th amended this rule. Get out your copy of the amateur regulations and refer to Rule

402. In the second line, strike out the words "modified or."

Any station license may now be modified, as for a change of address, simply by applying for modification on Part II of the amateur application form, without proving activity. Activity still must be proved before renewal of an expiring station license may be obtained, but no existing amateur station license will expire before next January.

At the request of F.R.C. we repeat the suggestion that amateurs possessing both a "fixed" station license and a portable station license voluntarily surrender the latter to the F.R.C. at Washington for cancellation. The regulations in effect since last October permit portable operation under the "fixed" license without special authority. The request obviously does not apply to those whose only station license is for portable equipment.

# A Single-Tube Short-Wave Converter

An Effective Circuit With Band-Spread Tuning

By Clark C. Rodimon, Managing Editor

**J**UDGING from the number of requests received by the Technical Information Service, there certainly is demand for a simple high-frequency converter for short-wave reception in conjunction with a broadcast receiver. Several such converters have been described in *QST* and the *Handbook* in the past but these have been made more or less obsolete by the recent developments in tubes and circuits. To bring converter design up to date and to supply this demand gave incentive for building the simple gadget that is the subject of this article.

Now a converter is essentially no more, or no less, than the input end of a short-wave superhet. Its business is to convert the incoming signal to one of intermediate frequency, which intermediate frequency may be in the broadcast band so that any good b.c. receiver can be used to furnish the i.f. amplifier, second detector and audio. Since the conversion process is accomplished by heterodyne action, with a local oscillator voltage combining with the incoming signal to give the i.f. beat, the essential elements in the converter are a first detector circuit tunable to the incoming signal frequency and a local oscillator circuit that is always tuned intermediate frequency different from the incoming signal frequency. General practice in short-wave superhet design is to use separate tubes for the first detector and h.f. oscillator, principally because separating the two jobs makes possible better oscillator stability. But in this case it was decided to adopt modern b.c. superhet design and use one of the new pentagrid converter tubes to do both jobs. This type tube (2A7 and 6A7) contains two more or less separate sets of elements, a triode section for the oscillator circuit and a tetrode screen-grid section for the first detector circuit, the oscillator plate being between the detector grid and its plate so as to give electron coupling.

This intimate association of the detector and oscillator circuits leaves some liability for undesirable reaction of detector tuning on the oscillator frequency, an objectionable feature overcome by *QST*'s original adaptation of the separate electron-coupled oscillator to modern h.f. superhet design, and one object of our trying the single tube arrangement was to find out just how serious this trouble might be in short-wave work. Such reaction was found negligible in 'phone reception and hardly noticeable in c.w. reception where the change in audio beat-note makes it apparent. Outweighing this slight handicap are the more compact arrangement, slight simplification of the circuit and somewhat lower cost.

## CIRCUIT FEATURES

The circuit of the converter, shown in Fig. 1,

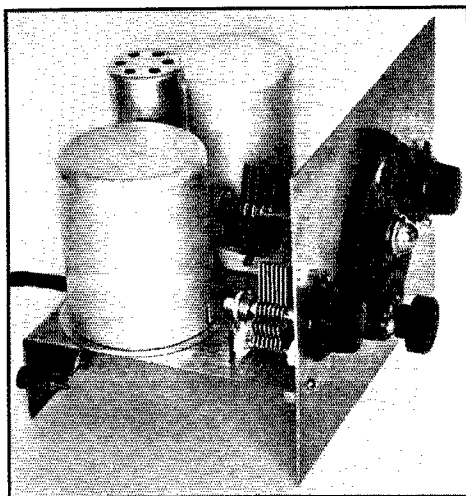

THE COMPLETE CONVERTER UNIT

is little different from usual except for the i.f. output. To provide a favorable coupling between the converter's high-impedance plate circuit and the low-impedance antenna input circuit of the b.c. receiver, a step-down transformer is used. This transformer has a tuned primary (tuned to the same frequency as the b.c. r.f. circuits, of course) and a smaller untuned secondary that is tightly coupled to the primary, so that the secondary and antenna coil of the b.c. receiver provide a low-impedance link coupling of good efficiency and

small pick-up between the converter and the receiver with which it is used.

The high-frequency input and oscillator circuits have been designed to make use of standard short-wave plug-in coils, thereby simplifying construction for the many builders who already have such coils on hand. The coils used in this instance are from a National SW3 (the same as used also in the SW5 and SW45). To give suitable tracking of oscillator and first-detector tuning a few grid turns are removed from some of the

oscillator coils and to give adequate oscillator feedback a few turns are added to the oscillator tickler windings, as explained later. With the tank-condenser system of tuning used, satisfactory tracking is obtained without adding separate series (tracking) condensers for each oscillator

mounted one either side of the tube and directly behind their respective padding condenser.

After these main pieces of apparatus have been mounted and the few necessary holes drilled through the base for coil connections, the whole chassis should be dismantled and the aluminum given a bath in household lye and water. This operation should be left until this time because scratches made during construction fade nicely into the background, leaving a finished appearing chassis. In connection with the "cooking" a word of caution might give discomfiture to the builder and the rest of the household. The lye solution is fairly potent and should not be handled with uncovered hands. The fumes that accompany the chemical reaction being strong, the bath should be given in the open air. The process is much simpler than it is to relate but experience has shown that precaution is preferable. A pail of water alongside the lye and aluminum will serve for the rinse, which should be given immediately after the aluminum is removed from the bath.

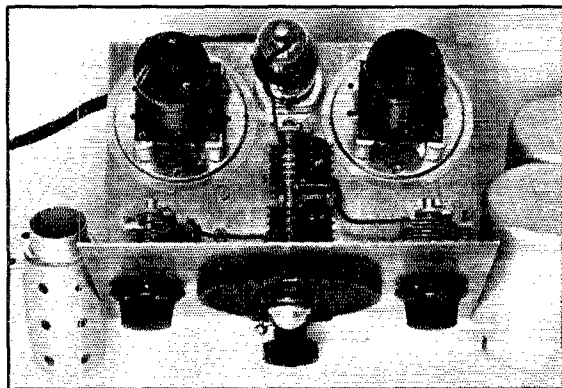

TOP VIEW OF THE SINGLE-TUBE HIGH-FREQUENCY CONVERTER

*Tube and coil shields are removed showing the simplicity of the top section which is practically devoid of wiring. The detector padding condenser is at the left with band-spread condenser in the middle and oscillator padding condenser at the right. The tube is directly in back of the band-spread condenser. The supply cable at the rear contains four wires for heater and plate supplies.*

coil. Single-control band-spread tuning in suitable slices anywhere in the 1400 to 19,000 kc. total range obtained with the five sets of coils is provided by the two-section midjet gang condenser having the separate 100- $\mu$ fd. midjets as "paddingers" in parallel.

#### CONSTRUCTION

The first step is to pick out some aluminum sheets for the panel and base. One piece 7 by 9 inches serves for the panel and a piece 8 by 9 inches is for the base. The base piece is bent at the rear to form an inverted "L," the 2-inch lip leaving the horizontal base 6 by 7 inches. Quarter-inch brass rod drilled and tapped for 6-32 machine screws serves to hold the base rigidly against the panel. Parts are then placed on the base, starting with the split-stator tuning condenser centered and flanked on either side by detector and oscillator circuit padding condensers. These condensers are fastened to the base, the two padding condensers being of the single-hole mounting type so that they act as further support for the panel. The dial used to tune the main condenser is a Type B National which provides a bearing and support for the condenser shaft. Directly in back of the band-spread condenser a hole is cut or punched for the sub-panel tube socket. Each coil mounting is placed over the base of its coil shield, the coil assemblies being

#### ASSEMBLY AND WIRING

Once more the chassis is assembled and the apparatus mounted in proper order. Next, comes the mounting of the resistors and condensers under the base of the converter. A fiber angle is used to anchor many of the terminals in this case. Exact placement is not important, although the desirability of short leads should be kept in mind.

With the National coils that are coded by a slot on the lip of the form, the coil mountings should

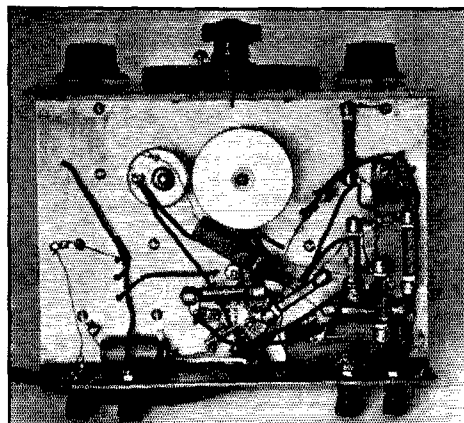

BOTTOM VIEW SHOWING THE RESISTORS AND FIXED CONDENSERS

*The binding posts at the left are for antenna and ground; those at the right being the converter output posts. The shielded mounting for the plate circuit transformer is shown in the center, with its midjet condenser at the left.*

be placed so that this colored slot will be toward the side of the converter when the coils are in place. Habit in using those same coils in receivers dictated this arrangement. Actually, the coils will only fit in one position, so final results will not be changed if the coils are mounted otherwise.

Now it is time to wire. All leads are run according to the axiom, "a straight line is the shortest path between two points." Soldering lugs under several of the screw heads serve as grounds in convenient places. The tube socket terminals should be marked in pencil before much wiring is done, a bottom plan of the Type 'A7 connections being shown with the diagram of Fig. 1.

#### OUTPUT TRANSFORMER

In the i.f. output transformer, the plate coil is a standard universal-wound i.f. coil of inductance between 1 and 1.2 millihenry. The secondary or output coil is of the same size with half of its turns removed. The two coils are jammed together on a wooden dowel and mounted inside a cut-down tube shield so that there is a clearance of about  $\frac{5}{8}$ -inch on all sides. The shielded "walnut" condenser tunes the primary to 600 kc. or so.

#### COIL DATA

Coil No.	Band Coverage	Detector Coil		Oscillator Coil		Wire Size*
		L <sub>1</sub>	L <sub>2</sub>	L <sub>3</sub>	L <sub>4</sub>	
1—Black	19,000—11,250	6 $\frac{1}{4}$	3	6 $\frac{1}{4}$	5	18
2—Red	12,500—7,000	12	3	12	7	18
3—White	7,500—4,100	19	4	15	8	18
4—Green	4,200—2,400	35	4	27	12	24
5—Blue	2,500—1,400	62	4	50	24	28

\* Refers to L<sub>1</sub> and L<sub>3</sub>. L<sub>2</sub> and L<sub>4</sub> are all wound with No. 30 d.c.c. wire. Complete windings of L<sub>1</sub> and L<sub>3</sub> occupy 1  $\frac{1}{2}$  inches on the forms.

As previously mentioned, standard manufactured coils are used because of their wide availability, although similar coils can be made up by the constructor. The detector coils need no alterations, the green winding of a few turns in the slot being used for the antenna coil, L<sub>1</sub>, and the original grid winding, which is the main winding of solid wire, is used for L<sub>2</sub>. The interwound primary is not used. In all cases it was found advisable to add a few turns of No. 30 d.s.c. wire to the oscillator tickler, L<sub>3</sub>. This corresponds to L<sub>1</sub> on the detector coil and is wound in the slot at the bottom of the form. The table shows the correct number of turns for each set of coils.

On the lower frequency bands, L<sub>4</sub>, the main winding on the oscillator coil which corresponds to L<sub>2</sub> on the detector coil, should be modified.

This is done not as an absolute necessity but for better tracking of the tuning. If one has "borrowed" these coils from his short-wave receiver and expects to return them, however, this winding should not be touched. As pointed out, it merely facilitates tuning and allows complete coverage on any set of coils. Coil set No. 1 (with black marking) tracked over the entire range and the only change was to add 3 turns on the oscillator

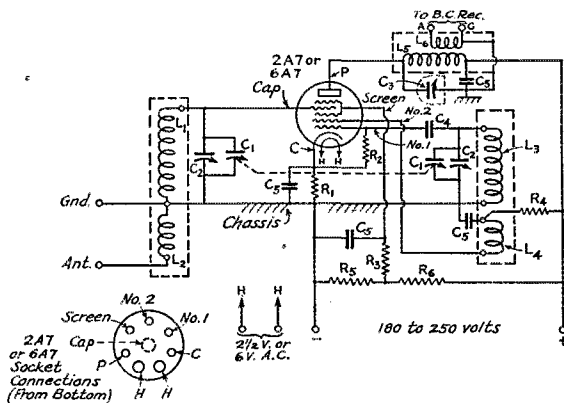

FIG. 1—CIRCUIT DIAGRAM OF THE ONE-TUBE CONVERTER

- L<sub>1</sub>, L<sub>2</sub>, L<sub>3</sub> and L<sub>4</sub>—Detector and oscillator coils. See table and text.
  - L<sub>5</sub>—1.2-millihenry i.f. transformer winding (465- or 500-kc. type).
  - L<sub>6</sub>—Same as above with approximately one-half turn removed.
  - L<sub>3</sub> and L<sub>5</sub> coupled as closely as possible. See text.
  - C<sub>1</sub>—Two-section midget tuning condenser, 35- $\mu$ fd. per section (Hammarlund MCD-35-X).
  - C<sub>2</sub>—Padding condensers, 100- $\mu$ fd. midgets (Hammarlund MC-100-M).
  - C<sub>3</sub>—I.f. tuning condenser, 100- $\mu$ fd. shielded midget (National W-100).
  - C<sub>4</sub>—250- $\mu$ fd. mica (grid condenser).
  - C<sub>5</sub>—0.1- $\mu$ fd. paper (by-pass condensers).
  - R<sub>1</sub>—250- or 300-ohm 1-watt (cathode resistor).
  - R<sub>2</sub>—25,000-ohm 1-watt (oscillator grid leak).
  - R<sub>3</sub>—25,000-ohm 1-watt (screen-grid series resistor).
  - R<sub>4</sub>—60,000-ohm 1-watt (oscillator plate series resistor).
  - R<sub>5</sub>—40,000-ohm 1-watt (voltage divider resistor).
  - R<sub>6</sub>—60,000-ohm 1-watt (voltage divider resistor).
- Oscillator and detector coil shields are National Type B30, 3-inch diameter. The i.f. transformer shield is a cut-down National TS tube shield (1  $\frac{1}{2}$ -inch length, 2-inch diameter).

tickler coil, L<sub>3</sub>. Oscillator coil No. 2 (red) only needed 5 turns added to L<sub>3</sub>. Two turns were removed from L<sub>4</sub> on the No. 3 set of coils and seven turns were added to L<sub>3</sub>. The oscillator coil of the No. 4 set had 6 turns removed from L<sub>4</sub> and 14 turns added to L<sub>3</sub>. The last set, No. 5, needed 10 turns removed from L<sub>4</sub> and 20 turns added to L<sub>3</sub> on the oscillator coil. After these changes were made the two padding condensers tracked evenly over the entire range of each coil set.

#### POWER SUPPLY

Preliminary work was done with a separate power supply which delivered 2.5 and 200 volts.

(Continued on page 38)

# The Operation of R.F. Power Amplifiers

## Checking Excitation — Output Circuit Considerations

### In Two Parts — Part II\*

By H. A. Robinson, W3LW \*\*

In this sequel to Part I of his article, W3LW continues his graphical analysis of the practical aspects of r.f. power amplifier operation in amateur transmitters. It deserves serious study by every amateur who really wants to know the how and why of his transmitter's operation.—EDITOR

HAVING reviewed the underlying principles of the universal method of tuning by the dip and rise of the plate milliammeter and the importance of the tube limitations, we shall proceed to a consideration of a practical means of checking the grid excitation of the r.f. power amplifier, which method is similarly applicable to the adjustment of the various stages of the exciter unit.

Since, as previously noted, the time-honored "cut-and-try" method becomes imperative in adjusting the various stages of the transmitter, a means of indicating the effect of the various adjustments is most helpful. The diagram of Fig. 8A shows a simple method which causes little departure from the actual operating conditions. It consists essentially in employing the grid of the r.f. amplifier tube as a simple rectifier, taking the rectified grid current as a relative measure of the available grid excitation. The grid leak and fixed bias should be essentially the same as that to be employed in operation.

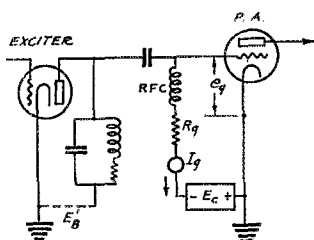

FIG. 8A—ARRANGEMENT FOR USING THE R.F. POWER AMPLIFIER AS A V.T. PEAK VOLTMETER FOR CHECKING ITS OWN GRID EXCITATION VOLTAGE

If an absolute measure of the r.f. grid excitation voltage ( $e_g$ ) is desired, a low-range grid milliammeter should be employed together with

a "B" eliminator or other available low-current bias supply at  $E_c$ .  $E_c$  should have available approximately 80% of the d.c. plate voltage of the preceding stage. Apply the excitation with the full value of bias ( $E_c$ ) and decrease this value

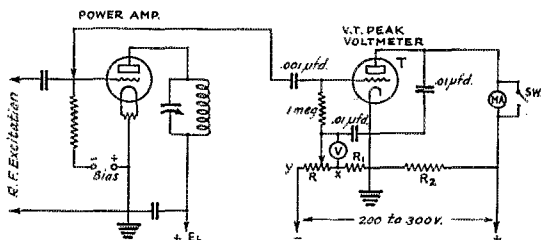

FIG. 8B—CIRCUIT OF A SEPARATE V.T. PEAK VOLTMETER FOR MEASURING R.F. GRID EXCITATION VOLTAGE UNDER ACTUAL OPERATING CONDITIONS

R—50,000-ohm wire-wound potentiometer.  
 $R_1$  and  $R_2$ —Approximately 1000- and 5000-ohm, respectively, for Type 56 or 37 tube. See text.  
 MA—0-1 d.c. milliammeter.  
 V—High-resistance d.c. voltmeter, range suitable for B-supply voltage.  
 T—Type 56 or 37 tube for low- and medium-power amplifiers, up to 50-watt; Type 10 for higher-powered stages.

until the rectified grid current just tends to read. The d.c. value of bias ( $E_c$ ) is then equal to the peak value of the available excitation. With this method the excitation voltage will probably be lessened somewhat when the r.f. amplifier has its bias returned to normal. For a more accurate check, a separate peak voltmeter tube can be connected to the grid of the r.f. amplifier (through a capacitor) and the excitation measured under actual operating conditions.

A separate vacuum-tube peak voltmeter suitable for this purpose (as well as having numerous other uses around an amateur station) is shown in Fig. 8B. The plate power supply can be a convenient "B" eliminator, since only a few milliamperes are required. A tube of the 37 type will be satisfactory for low-power transmitters, although for power amplifiers exceeding a 50-watt a

\* Part I, "The How and Why of Tuning Procedure," appeared in the February, 1934, issue of QST.

\*\* Silver Lake Farm, Willow Grove, Pa.

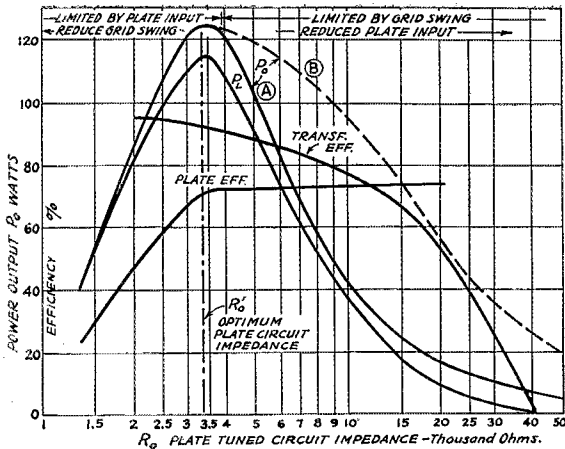

FIG. 9—TYPICAL POWER AMPLIFIER PERFORMANCE AS A FUNCTION OF PLATE TUNED-CIRCUIT IMPEDANCE

Type 10 tube is preferable with the higher-voltage "B" supply required.

In the initial adjustment the bias potentiometer  $R$  of the peak voltmeter is set with the arm at point "X." Either  $R_1$  or  $R_2$  is then varied until the plate current, as indicated by the low-range milliammeter  $MA$ , is just cut off (less than 0.05 ma.). This adjustment is made with no excitation on the power amplifier or with the peak voltmeter disconnected from this stage.

When measuring peak voltages the bias potentiometer arm is set at the maximum bias "Y" and the shorting switch around the plate milliammeter opened. If there is sufficient "B" voltage (equal to or greater than the peak voltage being measured) no deflection of the plate milliammeter will be noted. Decrease the bias potentiometer setting until the voltmeter's plate milliammeter just shows a tendency to deflect. The d.c. voltage reading of the bias voltmeter  $V$  is then equal to the peak voltage being measured, with respect to ground.<sup>4</sup>

<sup>4</sup>This peak voltmeter can be employed for measuring peak audio frequency voltages

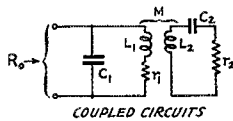

COUPLED CIRCUITS

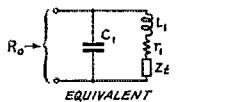

EQUIVALENT

$$X_{11} = 2\pi f L_1$$

$$X_m = 2\pi f M$$

$$X_{22} = 2\pi f L_2 + \frac{1}{2\pi f C_2}$$

$$R_{o\max} = \frac{L_1}{C_1(T_1 + T_2)}$$

$$\text{TRANS. EFF.} = \frac{P_o}{P_i} = \frac{T_{12}}{T_1 + T_2} = 1 - \frac{R_o'}{R_{op}}$$

$Z_L =$  TRANSFERRED IMPEDANCE

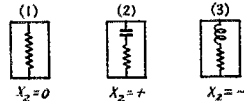

$$Z_L = \sqrt{\frac{T_{12}^2 + X_{12}^2}{T_2^2 + X_2^2}}$$

$$T_{12} = \frac{X_m^2 T_2}{T_2^2 + X_2^2}$$

$$X_{12} = -\frac{X_m^2 X_2}{T_2^2 + X_2^2}$$

FIG. 10—COUPLED CIRCUIT RELATIONS AND THEIR EQUIVALENTS

Typical tank circuit constants for 7200 kc:  
 $L_1 = 5 \mu\text{h}$ ,  $C_1 = 98 \mu\text{fd}$ ,  $r_1 = 1.2 \text{ ohms}$   
 $L_2 = 4 \mu\text{h}$ ,  $C_2 = 122 \mu\text{fd}$ ,  $r_2 = 100 \text{ ohms}$

With an indicator of this or similar type moved from stage to stage, the various adjustments of the stages of the exciter unit can be made with a continuous check on their effectiveness and with a practically exact measure of the grid excitation supplied to the final r.f. power amplifier.

#### POWER OUTPUT AND TANK CIRCUIT IMPEDANCE

The consideration of the effect of the tuned tank circuit impedance upon the power output and plate efficiency of the r.f. power amplifier is of utmost importance. The curves of Fig. 9 are typical of the effect of the plate tuned circuit impedance (loading) upon the power amplifier performance. These curves are for a single 203A operating at 7200 kc. and show the variation of r.f. power output ( $P_o$ ) to the tuned tank, the power transferred to the inductively coupled load or antenna ( $P_i$ ), the plate efficiency and the tuned circuit coupling transformer efficiency, as functions of the tuned circuit impedance of the plate tank (tuned to resonance and

hence equivalent to a pure resistance; see Fig. 5).

The diagram of Fig. 10 shows the coupled circuit arrangement employing the familiar inductive coupling and considering the antenna or feeder system as representing a pure resistance load ( $r_2$ ). Any reac-

tion by increasing the .01- $\mu\text{fd}$ . by-pass capacitors to 1  $\mu\text{fd}$ .

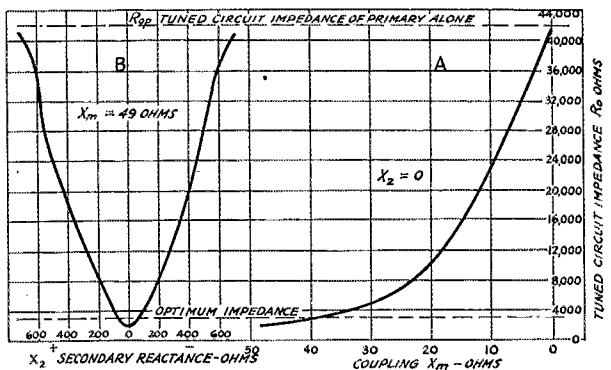

FIG. 11—TUNED-CIRCUIT IMPEDANCE VARIATION  
 A—Secondary resonant; B—Tuning secondary.

tive components could be lumped with the secondary reactance. Further consideration of this equivalent load will be made later. The d.c. bias, plate and r.f. excitation voltages employed are given in the data of Table I,<sup>9</sup> together with similar data for tubes of other types. The values of d.c. plate current, grid current, power output, plate efficiency and grid driving power vary with the tuned circuit impedance and other adjustments, and only the values corresponding to a nearly optimum adjustment with a reasonable degree of grid driving power are given in the table.

Considering the relations shown by the curves of Fig. 9 and neglecting, for the moment, the actual means by which we can vary the tuned circuit impedance of the plate tank (always keeping the tank tuned to resonance), let us impose the condition that the power amplifier tube shall be operated at the normal rated d.c. plate voltage with the grid excitation always adjusted so that the d.c. plate current shall not exceed the normal rating. In amateur practice these limitations may be 150% of the normal rated values, but the principles are still unchanged. If now we have available, as the output of the exciter unit, a limited value of grid excitation (a nominal value of 160

volts was found (experimentally) to give a very fair value of plate efficiency (approximately 70%) and to require low grid driving power.

Referring to Fig. 9, for these conditions of operation and with very high values of tuned circuit impedance, the grid excitation was insufficient

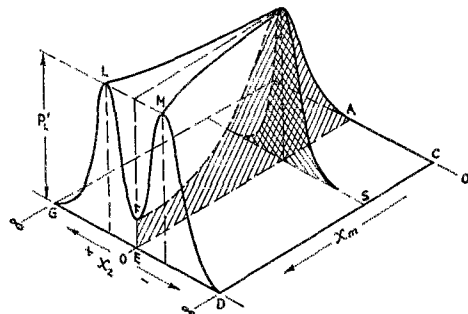

FIG. 13—SPACE DIAGRAM OF LOAD POWER VARIATION

to drive the power amplifier to draw normal plate current; hence both the power output and input were low with fairly high plate efficiency. Decreasing the value of the tuned-circuit impedance, the power output and input both rise with a negligibly slight drop in plate efficiency. This continues until at a certain optimum value of tank impedance ( $R_o'$ ) the available grid excitation is sufficient to draw normal plate current on the power amplifier. At this point the power output reaches a maximum and the plate efficiency is still quite high. Decreasing further the value of the tuned circuit impedance we must reduce the grid swing proportionally in order that the power amplifier plate current will not exceed its normal value. Thus the power output drops off with the plate input remaining the same, resulting in a rapid decrease in plate efficiency.

If we had available more grid excitation, an increased grid swing would give more power output for values of the tuned circuit impedance higher than the optimum, as shown by the dashed curve B. For a different value of grid bias the whole curve would be shifted, although the general shape would remain unchanged. It is thus apparent that for given operating conditions (bias, excitation, etc.) there is an optimum value of the plate tuned circuit impedance.

#### COUPLED CIRCUITS AND TANK IMPEDANCE

Diverting our attention to Fig. 10 and reviewing briefly the principles of coupled circuit theory, we find that our coupled circuit can be reduced to an equivalent plate tuned circuit having the same elements as the original primary tuned circuit with the addition of a transferred impedance ( $Z_t$ ), resulting from the coupling of the

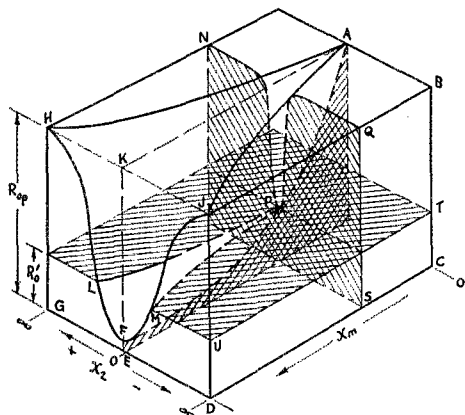

FIG. 12—SPACE DIAGRAM OF TUNED-CIRCUIT IMPEDANCE VARIATION

volts r.m.s. in this case), our power amplifier bias is selected with due consideration of this available grid swing. Higher values of bias should accompany higher available grid excitation. It is notable that the grid losses of the power amplifier, which must be supplied by the exciter unit, increase rapidly with the increasing grid excitation required to obtain the maximum power output from the power tube when excessively high bias is employed (Fig. 2), with the result that the slight increase in power amplifier plate efficiency is more than off-set by the power required in the

<sup>9</sup>Spitzer, "Grid Losses in R.F. Power Amplifiers," Proc. I.R.E., June, 1929.



secondary, added in the inductive branch. In general this transferred impedance comprises both a resistive ( $r_{12}$ ) and reactive ( $x_{12}$ ) component, each of which varies directly as the square of the coupling ( $X_m$ ). It should be noted that the *transferred reactance* is opposite in sign to the reactance of the secondary. In the special case when the

to decrease further as a result of the increasing transferred resistance. However, from a consideration of the transferred impedance relations, it can be seen that consequent detuning of the secondary ( $X_2$  not 0) results in a decrease of transferred resistance and the tuned circuit impedance increases correspondingly. The curve *B* of Fig. 11 shows this relation. The primary tank tuning capacity must be slightly readjusted to compensate for the transferred reactance to keep the tank tuned to resonance. It will be noted that there are two values of secondary reactance (two settings of the secondary tuning capacity, one either side of the previous resonance setting) at which the optimum tank impedance is obtained.

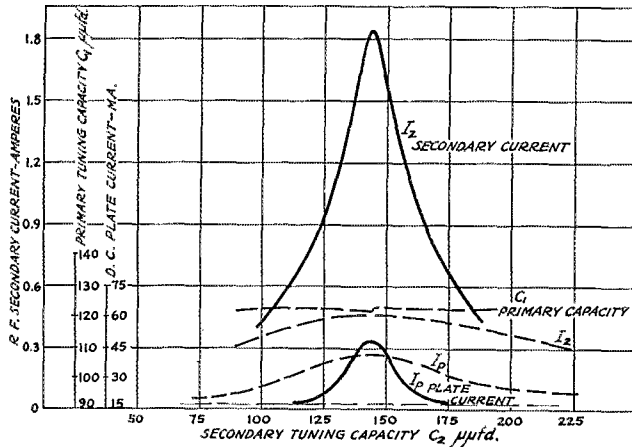

FIG. 14—SINGLE-POINT ANTENNA TUNING, OPTIMUM COUPLING

secondary is tuned to resonance ( $X_2=0$ ), the transferred impedance is a pure resistance.

Since the tuned circuit impedance, when the plate tank is tuned to resonance, varies inversely as the resistance in the inductive branch (Fig. 5) it is quite apparent that the effect of increasing the coupling between the primary tank and the secondary, resulting in the increase of transferred resistance, would be accompanied by a considerable decrease in the resultant tuned circuit impedance. The curve *A* of Fig. 11 shows this effect for the 7200-ke. coupled tank circuit of Fig. 10. The primary impedance drops from the value of 42,000 ohms ( $R_{op}$ ) with no secondary coupled to it, to lower than 2000 ohms for a coupling impedance of 50 ohms ( $X_m$ ). This curve is plotted for a resonant secondary or load circuit ( $X_2=0$ ) and shows how the tank impedance of the power amplifier (always tuned to resonance) can be varied over wide limits by coupling to the antenna and how thus we secure the optimum impedance for the particular conditions of bias and grid excitation. It will be noted, for the particular 203-A power amplifier under consideration, that the optimum tuned circuit impedance of 3200 ohms is obtained with 38 ohms coupling ( $X_m$ ). Increasing the coupling beyond this value causes the tuned circuit impedance

to decrease further as a result of the increasing transferred resistance. However, from a consideration of the transferred impedance relations, it can be seen that consequent detuning of the secondary ( $X_2$  not 0) results in a decrease of transferred resistance and the tuned circuit impedance increases correspondingly. The curve *B* of Fig. 11 shows this relation. The primary tank tuning capacity must be slightly readjusted to compensate for the transferred reactance to keep the tank tuned to resonance. It will be noted that there are two values of secondary reactance (two settings of the secondary tuning capacity, one either side of the previous resonance setting) at which the optimum tank impedance is obtained.

In the space diagram of Fig. 12 we have represented the general variation of the tuned circuit impedance (plotted on the vertical axis) as a function of both the mutual inductive coupling ( $X_m$ ) and the secondary reactance ( $X_2$ ). Considering a vertical plane passed through the block at the points *AKBP*, corresponding to a resonant secondary ( $X_2=0$ ), the variation of the tuned circuit impedance in this plane with increasing coupling corresponds to that of curve *A* of Fig. 11. For a fixed value of the coupling the tuned circuit impedance varies with the secondary reactance as shown by the intersection of the surface with a vertical plane through the points *HGDJ* or parallel thereto. This variation is similar to that of curve *B* of Fig. 11.

The ratio of the r.f. power transferred to the load (plotted as  $P_L$  in Fig. 9 for the coupled circuit here considered) to the total r.f. power out-

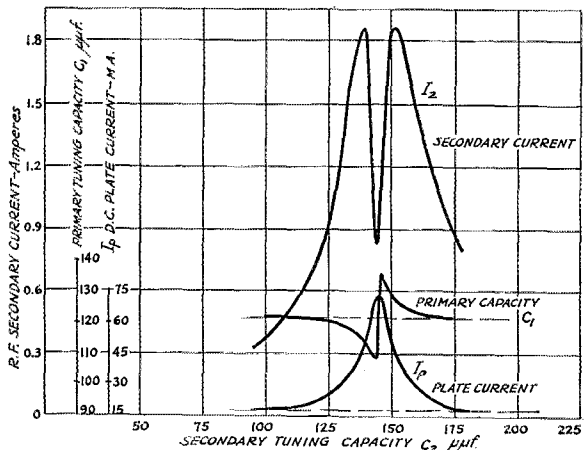

FIG. 15—TWO-POINT ANTENNA TUNING, COUPLING GREATER THAN OPTIMUM

put of the amplifier is here termed the *transformer efficiency*. From the relations of Fig. 10 it can be seen that the transformer efficiency increases as the resistance of the primary alone ( $r_1$ ) becomes small in comparison to the transferred load resistance ( $r_{12}$ ). The curve of Fig. 9 shows the variation of this efficiency for the coupled tank circuit of Fig. 10. It will be observed that the power delivered to the load increases with the decreasing tuned circuit impedance, resulting from the increasing coupling, up to the condition where the optimum impedance is reached. The transformer efficiency continues to rise, though more slowly, with increasing coupling. A transformer efficiency of 92% was secured at optimum coupling. A lower-resistance primary tank circuit (inductor) would result in a further slight increase of this efficiency.

#### TWO-POINT TUNING OF THE LOAD

The curves of Fig. 13 show graphically in a space figure the variation of r.f. power transferred to the load as a function of the coupling and secondary tuning. This figure corresponds to the tuned circuit impedance variation of Fig. 12 and both figures should be considered together. For the secondary tuned to resonance, increasing the coupling results in a rapid increase in power transferred to the load. This increase continues until the coupling corresponds to that at which the optimum tuned circuit impedance obtains. Further increase of the coupling results in a decrease of power in the load as shown by the curve *EFPA* of Fig. 12. For values of the coupling greater than the optimum, detuning of the secondary on either side of resonance results in an increase in load power, reaching peaks at the points where the tuned circuit impedance has reached its optimum value. The resulting two-point secondary tuning so frequently encountered in practice is apparent. When detuning the secondary the primary tuning capacity must be readjusted to keep the tank tuned to resonance as would be expected from a consideration of the transferred reactive components.

#### CHECKING THE LOAD COUPLING

The curves of Figs. 14 and 15 show a number of experimental curves for a Type 65 at 3900 kc., illustrating these tuning relations. The curves of these two figures show the variation of the secondary load current (antenna current) and the corresponding d.c. plate current variation, as the

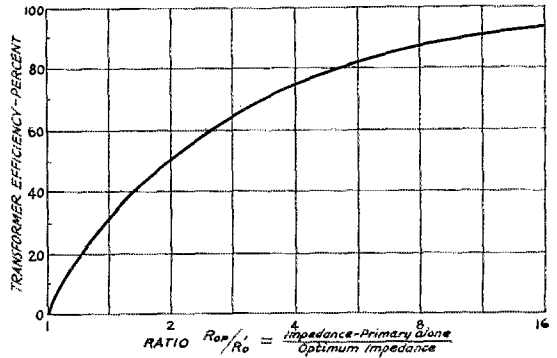

FIG. 16.—VARIATION OF COUPLING TRANSFORMER EFFICIENCY WITH TUNED CIRCUIT IMPEDANCE

secondary circuit is tuned through resonance. The change in tank capacity required to keep the primary tuned to resonance is also plotted. In Fig. 14 optimum coupling was obtained in the case of the solid curves for a fairly low resistance load (antenna system operating on the fundamental). The dashed curves were obtained for a load resistance seven times greater with coupling slightly below optimum. The broader tuning for the higher resistance load is apparent. In Fig. 15 the same load as for the solid curves of Fig. 14 was employed, but the coupling was increased to a value somewhat greater than that for optimum impedance. Thus, when the secondary is tuned to resonance the transferred resistance pulls the tank circuit impedance down below the optimum value for the conditions of bias and grid excitation here employed. The resulting high value of

(Continued on page 76)

TABLE I  
TYPICAL R.F. POWER AMPLIFIER PERFORMANCE AND OPERATING DATA

Tube Type	D.C. Plate Voltage $E_b$ Volts	D.C. Plate Current $I_p$ Ma.	D.C. Bias Voltage $E_c$ Volts	D.C. Grid Current $I_g$ Ma.	R.F. Grid Excitation $E_g$ Volts R.M.S.	Plate Tuned Circuit Imped. $L/RC$ Ohms	R.F. Power Output $P_o$ Watts	Plate Efficiency $\eta$ Percent	Grid Driving Power $W_a$ Watts
211	1000	175	-100	19	160	3100	122	69.7	3.9
203A	1000	175	-75	35	145	3100	123	70.3	6.7
204A	2000	275	-175	131	328	4030	405	73.6	56
861	3000	350	-200	40	455	4300	665	63.5	22.5

# Announcing— The A.R.R.L. "20th Anniversary Relay"

April 7th (5p.m. E.S.T.) through April 8th (midnight E.S.T.)

**M**R. MAXIM, president and founder of the American Radio Relay League has seen our organization built up from small beginnings through two decades to our present strength and status. On the twentieth anniversary of national amateur organization it seems appropriate that we have a word from our founder. It was his vision that made possible the *first and only* radio amateur society of nationwide proportions, of, by, and for the amateur.

It was a momentous idea, the conception of a national society of transmitting amateurs organized for mutual advancement. We have gone a long way in twenty years of progress! From a handful to 40,000 amateurs, from 200 meters to high frequencies, from spark to vacuum tube, from local work that thrilled, to coast-to-coast and trans-ocean work considered commonplace! Mr. Maxim's *idea* blossomed into *actuality*, the A.R.R.L. of today, a strong and truly representative organization making itself felt in national and international radio councils.

Mr. Maxim, our founder-president, has a message for us on this twentieth anniversary. On April 6th, 1914, the first tangible steps were taken to make A.R.R.L. a going organization. On April 7th, 1934, *every A.R.R.L. member is invited to start a reply* to Mr. Maxim's message, which is reproduced on this page. On this anniversary start a message through your own amateur radio station if possible. That will be *your* part in the A.R.R.L. anniversary . . . and you can help relay other messages and have a further operating part in the relay if you want to.

OUR PRESIDENT



In the beginning it was a problem to handle messages over the 26-mile distance between Springfield and Hartford. The difficulty was solved by coöperation between operators, by arranging for an intermediate relay point, by *organization*. To-day 10,000-mile relays are not uncommon. Messages from the far-off Philippines arrive in eastern U. S. A. but 48 hours old via A.R.R.L. Trunk Line. "Skip effect" on high frequencies offers new problems. QRM and

HARTFORD CONN WIAW NRI APRIL 6, 1934

ALL AMERICAN RADIO RELAY LEAGUE MEMBERS:

FOLLOWING MY ARRANGING OF A HARTFORD-WINDSOR LOCKS-SPRINGFIELD RADIO RELAY TWENTY YEARS AGO A RELAY COMMITTEE WAS APPOINTED BY THE OLD RADIO CLUB OF HARTFORD ON APRIL 7 1914. FROM THE WORK OF THIS COMMITTEE AND THE ORGANIZATION OF AMATEUR STATIONS ALL OVER THE COUNTRY RELAY ORGANIZATION BECAME AN ACTUALITY AND YOUR AMERICAN RADIO RELAY LEAGUE WAS BORN. A.R.R.L. HAS STEADILY GROWN IN NUMBERS AND STRENGTH UNTIL TO-DAY WE NUMBER ABOUT 20,000.

OUR A.R.R.L. HAS WEATHERED MANY STORMS, ITS STRENGTH GROWING WITH YOUR COÖPERATION AND SUPPORT. TO-DAY WE AMATEURS WHO BELIEVE IN THE POWER OF ORGANIZATION OWN OUR OWN OFFICIAL MAGAZINE QST. WE OPERATE OUR OWN STATIONS, EFFICIENTLY COMMUNICATING TO-DAY OVER DISTANCES WHICH SEEMED IMPOSSIBLE ABSURDITIES WHEN WE STARTED OUT IN 1914. WHERE WILL OUR PROGRESS LEAD US IN THE COMING YEARS?

ON THIS TWENTIETH ANNIVERSARY OF THE EXISTENCE OF ONE STRONG NATIONWIDE ORGANIZATION, FOREVER DEDICATED TO REPRESENT AND STICK UP FOR THE AMATEUR, I SHALL APPRECIATE IT IF ALL A.R.R.L. MEMBERS WITH STATIONS ACTIVE ON THE AIR WILL CONSIDER THIS A PERSONAL MESSAGE FROM ME AND START A RADIO REPLY. GIVE ME YOUR SUGGESTIONS FOR THE ADVANCEMENT AND ORGANIZATION BUILDING WHICH SHOULD BE ATTEMPTED IN THE NEXT DECADE. START A MESSAGE ON APRIL 7TH OR 8TH THROUGH YOUR STATION OR SOME OTHER AMATEUR STATION, FOR THE RELAYING OF THESE MESSAGES TO ME THROUGH ALL YOUR STATIONS SEEMS TO ME A FITTING WAY TO COMMEMORATE THE BEGINNING OF OUR RELAY LEAGUE. SINCERELY,

*Hiram Percy Maxim*

PRESIDENT, AMERICAN RADIO RELAY LEAGUE

QRN still have to be overcome. Planned routing, coöperation between all amateur operators to meet all our problems, and one strong organization are important to every one of us to-day, as always.

As you start your message to President Maxim, pause to think that A.R.R.L. is twenty years old and still growing; and that A.R.R.L., by, of, and for, the amateur is *your own* organization. It was made so by Mr. Maxim's plan that the League's policy-determination should always rest with a nationally representative group—your Directors, elected by you.

#### THE VICENNIAL RELAY

Since the League's organization was inspired by the "relay" idea, it appeals to us as good to pay our individual respects to our President by radio relay on the twentieth anniversary of the occasion, taking this opportunity to give him our best thoughts and suggestions for the betterment and further advancement of A.R.R.L. organization.

Starting on April 7th your A.R.R.L. Headquarters station, W1MK, will be operated continuously for two or three days to assist in the reception of your messages. Many other Hartford and Connecticut stations\* also will be organized and ready to take messages from *all outside points*. Connecticut operators will have a tough job (with every A.R.R.L. member sending a message) and they solicit your coöperation. The objective: to convey a message to our founder and president from every active League member—by amateur radio. All amateurs are invited to take part as fully as their time permits. Here's how:

1. Read President Maxim's message.
2. Write out and start a message in reply. (It is not necessary to give your message direct to W1MK or even to a Connecticut station. If direct QSP is possible this may be done but where conditions are uncertain it is much better to permit intermediate stations to help with your message, and make it a real relay through mutual operator-coöperation.)
3. Start messages any time between Saturday, April 7th (5 p.m. E.S.T., 4 p.m. C.S.T., 3 p.m. M.S.T., 2 p.m. P.S.T.) and Sunday, April 8th (midnight E.S.T., 11 p.m. C.S.T., 10 p.m. M.S.T., 9 p.m. P.S.T.). Messages should be relayed until they reach their destination (Connecticut) whether or not they reach this destination in the period designated for *starting* messages.
4. Make messages reasonably brief.
5. "CQ HPM" will be the general call used by stations having messages for President Maxim.
6. After your message is off the hook spend as

\*A list of Connecticut stations, and frequencies, appears in the Communications Department pages of this issue. They will be on the air awaiting your message, and those relayed from distant points.

much time as possible in assisting others; make yours a *relay* station as well as an *originating* station.

Work intelligently in this relay, please. (1) Do more listening. (2) Make calls short, broken with frequent listening periods. (3) Send messages in proper form—same as Mr. Maxim's. (4) Route messages carefully. (5) *Listen*, and then call operators in the right direction really in a position to handle effectively. (6) Help Connecticut stations\* in getting traffic from difficult points when possible. (7) No special report is *required* on this activity. Your message received will tell H.P.M. its own story. However, it is expected that ten letters of commendation will be given by President Maxim to those doing the best work in different parts of the country in the relay. Therefore, reports are invited and will be most welcome, so that all outstanding or unusual work can be fully credited. A postal card will do this.

—F.E.H.

## New England Division Convention

Hotel Clinton, Springfield, Mass.,

May 4th—May 5th

**Y**E TOWNE-CRIER in all New England towns will be shouting the forthcoming convention to be held under the auspices of the Springfield Radio Association and the Western Massachusetts Amateur Radio Association. The Committee in charge has planned a convention that will be long remembered, and every "Ham" should make arrangements to attend this established annual affair where every amateur will soon have an opportunity to meet old and make new friends.

The synopsis of the program assures speakers of prominence and a good time, and a cordial invitation is extended to everybody.

An initiation in the R.O.W.H., the secret fraternity of amateur radio, will be given. Full particulars will be given through publicity releases. Meanwhile, write Lawrence Reilly, Convention Secretary, 23 Highland St., Springfield, Mass.

## Iowa State Convention

(Midwest Division)

Savary Hotel, Des Moines, Iowa, April 20th—21st

**I**OWA always has had the reputation of having the most instructive convention of any section, and this year's affair under the auspices of the Des Moines Radio Amateurs Association will leave nothing to be desired.

It will be bigger, better—and, more fun.

Write to Frank J. Sadilek, Chairman, 4600 University Avenue, Des Moines, Iowa, and tell him you will be there.

# More on Overmodulation

## Coöperation Bringing Improvement—Further Measurements— Some Questions Answered

**T**HE article on overmodulation in the December, 1933, issue of *QST*, begot a surprisingly enthusiastic response, both in wholehearted application of its ideas by 'phone men (with generally improved conditions in the 'phone bands as a consequence), and in further data on measurements made by operators having oscillographic equipment. Several communications from the latter are especially interesting. One of these is from C. H. Vincent, W8RD, Packard Proving Grounds at Utica, Mich., well-known for his years of 'phone activity and for his technical ability:

"Glad to see your timely article in December, *QST* in connection with overmodulation.

"I had an opportunity to attach an oscillograph to my transmitter last week and was surprised to find that I was modulating approximately 130 percent on the peaks, with an average of around 115 percent. Was also surprised to discover that my equipment (Thordarson Class-B) was capable of modulating the four-hundred watt input more than two-hundred percent if opened up wide!

"Upon noting this I hooked on a dummy antenna, connected an audio oscillator and determined the exact input to the Class-B modulator tubes that would provide one-hundred percent modulation. I also noted the grid current to these tubes and find that in practice it is easier to hold the peaks down by watching this meter than it is to observe the Class-C plate meter; principally because the grid meter shows considerable movement before the plate meter begins to tremble.

"In any case I think your article is very much to the point and that it should be repeated at least every other issue. Also think Rodimon's article on a break-in is very timely. Have been equipped for this work for the past two years but seldom have an opportunity to use it and have therefore had no incentive to effect further improvements."

—W8RD

Another communication of particular interest is that of Samuel Woodworth, W8KIR, General Manager of the Onondaga Radio Broadcasting Corporation, Syracuse, N. Y., who anticipated publication of the article in his work of checking up on things wrong with 'phone operation:

"It may be of interest to learn that I have studied conditions on the 75-meter 'phone band since September. I have made many careful

observations on the condition of this band and, because so many of the transmitters had covered up the major portion of this band with poor quality (overmodulation), I determined to attempt a method of finding out exactly what the difficulty was with the average amateur transmitter. Therefore, in October, 1933, I procured a General Electric PM12-A2 oscillograph. Since we use this type of oscillograph in measuring the percentage of modulation at our broadcasting station, I thought it might be possible to do the same thing by adapting the oscillograph to the radio receiver. I immediately contacted Mr. Merkland of the Bell Telephone Laboratories who stated that it was possible.

"Results of the first day's operation were so interesting that, as would any other radio amateur, I spent considerable time checking the stations at the expense of ordinary routine. Over the period of the first week I checked 19 stations. These 19 stations (each station was of the high-powered type) were modulating from 106 to 320 percent of their carrier and the distortion was very bad on all of them. In fact, three stations were overmodulating so badly that during the time that they were speaking the carrier wave disappeared entirely. Incidentally, in order to get an accurate check on the percentage of modulation the incoming signal has to be at a strength of at least R7 without interference and with fading at a minimum.

"I checked 41 stations, the majority of these being in the first, second, third and eighth districts, and four stations being in the ninth district. Of the 41 stations checked, 28 were from 100 to 300 percent overmodulated, the other 13 stations checking from 40 to 96 percent. All the above stations were checked without the knowledge of the operators.

"Since the appearance of the article by Mr. Lamb in the December issue of *QST* I have checked 19 stations at the request of the stations themselves. Of these 19 stations I have found 13 of them overmodulated from 100 to 210 percent. Of these, 12 stations were Class-B modulated, one was Class-A prime and the others were using anything from Class-A to grid-bias modulation. Of the 13 stations overmodulated, there averaged a differential of 30 percent to 40 percent between their positive and negative peaks. One in particular was modulating 90 percent one way and 10 percent the other. Of

(Continued on page 82)

# Adding to the Single-Tube Transmitter

An R. F. Power-Amplifier and Antenna Coupling Unit Described

By George Grammer, Assistant Technical Editor

ONE outstanding feature of crystal-controlled transmitter design is the wide latitude in the choice of the paths by which a given objective can be reached. At one end of the chain is the oscillator, fairly well limited in frequency and power output under normal operating conditions; at the other end is the output tube, with power output and frequency a matter of individual choice. What is to come between the two?

Even more bewildering is the question that confronts the chap who has built himself a simple crystal oscillator such as that described in last month's *QST*,<sup>1</sup> perhaps as his first transmitter, and now wants to go on to something bigger and, he hopes, better. There is the oscillator; what next? To a very large extent the answer rests with the individual—what he hopes to do with the transmitter and how much he expects to spend on it. It is well to have a definite plan in mind so that the second step in building the transmitter will not be aimless, but part of an orderly program.

The chief considerations involved are: the band or bands to be worked, and the power output desired. Secondly, such things as convenience in operation and good keying (which includes elimination of keying interference) are worth careful attention. Possibly, also, the transmitter is to be used for 'phone work, which may bring about changes in design resulting from different excitation requirements. Already we have a formidable list. And since opinions and wants are as numerous as the individuals who have them, it is obviously impossible to continue a design along lines which will satisfy everyone, notwithstanding the fact that we all may

<sup>1</sup>"A One-Tube Crystal-Control Transmitter," *QST*, March, 1934.

have a common starting point—the oscillator. The best that can be done is to give one of many solutions and to use it as an example. The discussion of reasons for this feature and that should be helpful to those who wish to progress along different lines, but whose ideas on ways and means of doing it are nebulous.

## WHAT NEXT?

Since the decision has to be made, let us settle the question of where this particular transmitter is going right at the outset. First, the frequencies to be covered. It is our belief that a transmitter which is not ultimately capable of operating in five amateur bands falls short of present-day requirements; true, it may seldom be used in more than three or even two, but there always comes a time when work in fresh territory would be desirable, if not necessary. The ability to do so should be built into the transmitter right at the start; it

should not be necessary to perform a major operation on the set to move it from a familiar rut. In other words, the transmitter should be capable of working straight through from 1.75 mc. to 30 mc. Possibly the same sort of performance is not to be expected on 28 mc. as the other bands, but at least it should be possible to get enough output on that band to take part in the experimental work which goes on intermit-

tently in this least-understood territory. Contacts on 28 mc. have a peculiar "kick" that is lacking on bands where the expected usually happens.

Second, the power output. The requirements of the average amateur are met by a power output of about 50 watts, a figure which year in and year out has proved to be more than sufficient to provide the enjoyment which the same average amateur expects to get from his transmitter.

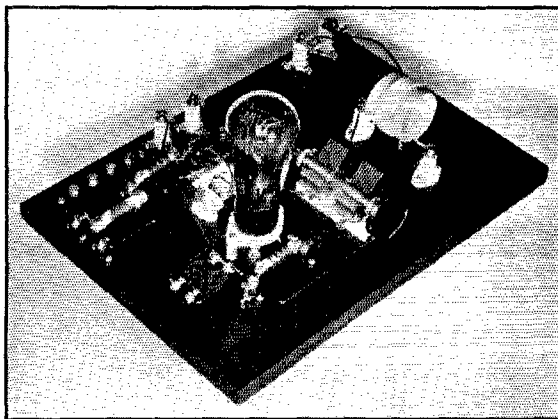

AN AMPLIFIER OF MODERATE POWER OUTPUT FOR THE CRYSTAL OSCILLATOR OF MARCH *QST*

This unit uses an 841 tube and has a power output of approximately 20 watts on the 1.75-, 3.5- and 7-mc. bands when used with a 500-volt plate supply.

More power than this may be desirable. If so, the present design can easily be enlarged upon, since amplifiers always can be added until the full kilowatt is reached.

Having decided the two major questions, we come now to consideration of the details. What tubes to use? Any of the new group of transmitting tubes will give an output of the order of what we have decided is needed. In the present case, the 830 is a good choice, since it gives the necessary output with fairly low plate voltage. Although not specially designed for ultra-high frequencies, the tube works well on all the bands we wish to cover with this transmitter. A 750-volt power supply will suffice for it, thus making the filter condensers relatively inexpensive.

To cover five bands, however, at least three stages will be needed in the transmitter. The oscillator and final stage are "set"; there remains only the question of the intermediate stage.

Although in the following discussion the second stage of the transmitter will be considered chiefly as a driver for the forthcoming final amplifier, it should be understood that this second stage in itself is capable of considerable output and is entirely adequate for general work in three amateur bands—1.75, 3.5 and 7 mc.—since the output is identical with that obtainable from a Type 10 amplifier. On 14 mc. the output is lower, but is still reasonable. For this reason we shall describe in this issue an antenna-coupling filter which will fit either this or the succeeding amplifier. The three units—oscillator, amplifier and antenna coupler—in themselves form a highly practical low-power transmitter, when equipped with a suitable power supply.

#### THE INTERMEDIATE AMPLIFIER

To do a good job of exciting the final stage, a power output of 8 to 10 watts will be required from the intermediate amplifier—little more, in fact, than is obtainable from the oscillator alone on the 1.75-, 3.5- and 7-mc. bands. The intermediate amplifier is a necessity for operation in the 14- and 28-mc. bands, however, because the output of the oscillator is not great enough at 14 mc., especially when a 3.5-mc. crystal is used, to

drive an 830 satisfactorily. A buffer stage also is helpful if the transmitter is to be used for 'phone work on the lower-frequency bands. And last but not least, the intermediate stage offers an excellent opportunity for clickless keying, since the keyed stage is isolated from the antenna.

These considerations have led to the adoption of a second stage consisting of a neutralized amplifier of ordinary design using a high- $\mu$  triode tube, in this case the 841. Keying requirements and adequate power output at the lower frequencies dictated the use of a neutralized amplifier in preference to a second 59 in the "universal exciter unit" arrangement.<sup>2</sup> Although the latter is exceedingly convenient in operation, the untuned coupling, made

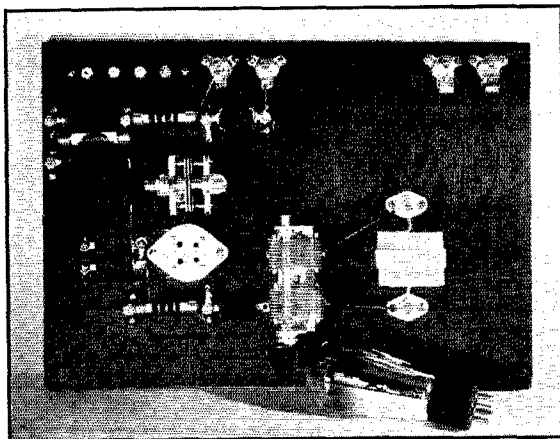

A PLAN VIEW OF THE AMPLIFIER  
*The construction is similar to that of the March oscillator.*

necessary on 1.75 and 3.5 mc. because the second 59 is unneutralized results in a power output insufficient for the present purpose on those bands, and the same lack of neutralization prevents clean-cut keying in the second tube.

The use of the 841 in preference to a less-expensive receiving tube also readily can be explained. Its high amplification factor makes it "handle" a good deal like a 46 in r.f. circuits; that is, the operating bias can come entirely from a grid leak, since the plate current will drop to a very low value if the excitation should fail, even without fixed bias of any sort. In fact, with the same power input and excitation, the power output will be approximately the same as that obtainable from a 46. But the 841 has one great advantage over the 46—its thoriated filament makes conspicuous by their absence those grid-emission troubles that limit the output of the 46, especially at the higher frequencies. Higher plate voltages and plate currents can be used safely, therefore. Within the last few months, too, the cost of the 841 has dropped to the point where it is relatively inexpensive—considerably less so, in fact, than the 10, to which it is equivalent in power output. The high  $\mu$  of the 841 makes it preferable to the 10 not only because fixed bias is unneeded, but because it is possible to key the tube in the grid circuit—and elimination of key clicks is relatively easy.

<sup>2</sup> "Tri-tet Multi-Band Crystal Control," *QST*, October, 1933; "A Simplified Five-Band Exciter Unit," *QST*, November, 1933.



So much, then, for the reasons behind the layout. We are now ready to get down to the details of construction of the intermediate amplifier. Space does not permit going on to the final amplifier, which will be shown along with the other units panel-mounted in the complete transmitter in a succeeding issue.

#### AMPLIFIER CONSTRUCTION

Two views of the amplifier unit are shown in the photographs. The circuit diagram is given in Fig. 1. The tank tuning condenser,  $C_5$ , has two sections having a capacity of 140  $\mu\text{fd.}$  each, giving an effective tuning capacity of 70  $\mu\text{fd.}$  with

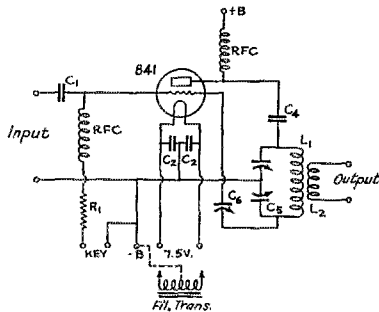

FIG. 1—THE 841 AMPLIFIER CIRCUIT

- $C_1$ —250- $\mu\text{fd.}$  mica condenser (Dubilier Type 3).
- $C_2$ ,  $C_3$ —0.005- $\mu\text{fd.}$  mica condensers (Dubilier Type 3).
- $C_4$ —0.002- $\mu\text{fd.}$  mica condenser (Dubilier Type 3).
- $C_5$ —Split-stator condenser, 140  $\mu\text{fd.}$  each section (Hammarlund Type MCD-140-M).
- $C_6$ —35- $\mu\text{fd.}$  midget variable condenser (Hammarlund Type MC-35-S).
- $R_1$ —7500-ohm non-inductive resistor, 5-watt size. (10,000 ohms will do if this size is not readily obtainable.)
- RFC—Short-wave chokes (National Type 100).

Band	Coil Data	
	$L_1$	$L_2$
1.75 mc.	75 turns	30 turns
3.5 mc.	35 "	12 "
7 mc.	20 "	7 "
14 mc.	7 "	2 "

The plate coils  $L_1$  are all close-wound, the diameter being 1½ inches. The 1.75-mc. coil is wound with No. 22 d.c.c.; the 3.5-7- and 14-mc. coils with No. 14 d.c.c. The coupling coil,  $L_2$ , is wound directly over  $L_1$ , centered along its length.

the two in series. Parallel plate feed is used, with a blocking condenser,  $C_4$ , to keep the d.c. voltage off the tank and neutralizing condensers.

The physical layout is straightforward and adapted to symmetrical panel layout. Since there is only one control that needs to be adjusted, that of plate tank tuning, the condenser  $C_5$  is located centrally on the baseboard. The output terminals, as in the oscillator, are brought out to isolantite stand-off insulators at the rear right corner of the board, therefore the tank coil and its mountings are to the right of  $C_5$ . The input terminals are similar insulators located along the rear edge slightly to the left of the center; a short connection from one of these goes to the coupling condenser,  $C_1$ , mounted on small porcelain

insulators. The other terminal of  $C_1$  connects to the stator plates of the neutralizing condenser,  $C_6$ , and from there a connection is made to the grid prong of the tube socket, which is mounted alongside the neutralizing condenser.  $C_6$  is supported from the board by a miniature porcelain stand-off under the front bearing; the wiring to the terminals at the rear keeps it firmly in place. The grid r.f. choke is also mounted on small stand-off insulators and is placed near the neutralizing condenser; the plate choke, similarly mounted, is in front of the tube socket. The plate blocking condenser,  $C_4$ , is between one choke terminal and the lug on the front stator-plate section of  $C_6$ .

Power supply connections are made to machine screws in a bakelite strip of the same construction as the terminal strip used on the oscillator. Only four connections are needed in this case, however. Along the left-hand edge of the board in front of the terminal strip are the small insulators which serve as keying terminals; one connects to the filament center-tap and the other to the grid choke through the grid resistor,  $R_1$ . The only wires under the baseboard are those going to the power-terminal strip; they drop through the baseboard and run to the terminal strip in channels cut in the bottom. As in the oscillator, no "hot" r.f. connections touch the baseboard—possibly a needless precaution, but one not hard to take.

The plate coils,  $L_1$ , are of construction similar to those already described for the oscillator, being wound on sheet celluloid over a cardboard mailing-tube mandrel. The coupling coil,  $L_2$ , a temporary expedient for working into the antenna

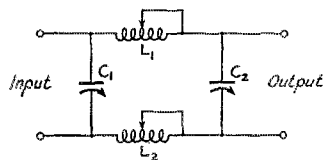

FIG. 2—CIRCUIT OF THE ANTENNA COUPLER  
 $C_1$ —500- $\mu\text{fd.}$  variable condenser, receiving type (Cardwell Type 123-B).  
 $C_2$ —220- $\mu\text{fd.}$  variable condenser, transmitting type (Cardwell Type 164-B).  
 $L_1$ ,  $L_2$ —25 turns No. 14 d.c.c. wire, diameter 1½ inches, tapped every five turns.

so the 841 can be used as an output amplifier before the final stage is completed, is simply wound over  $L_1$ , fastened in place with a little Duco Household Cement, and connected to a pair of flexible wires which run to the output posts.

Before going into the amplifier tuning, it is necessary to describe the antenna coupler, an important unit in the complete transmitter.

#### THE ANTENNA COUPLER

The antenna coupler, a diagram of which is given in Fig. 2, is of the "universal" type described by Arthur A. Collins in February *QST*.<sup>3</sup>

<sup>3</sup>Collins, "A Universal Antenna-Coupling System for Modern Transmitters," *QST*, February, 1934.

It is shown in one of the photographs. Although of the "O" or balanced type, it can easily be converted into a pi-section filter by shorting out one of the coils, both of which have been provided with a fair amount of inductance to take care of such a contingency. For a discussion of the usefulness of this device and its operating principles, the reader is urged to consult the article referred to. Not only does its use make practicable the coupling of the transmitter to almost any sort of antenna, but it also eliminates the troublesome constructional features always associated with variable inductive coupling.

In the antenna-coupling filter shown in the photograph, the input condenser,  $C_1$ , is at the right and the output condenser,  $C_2$ , at the left. Since the intended impedance of the coupler at the input end is of the order of 600 ohms, a receiving-type condenser has sufficient spacing to handle the amount of power which the 50-watt final stage of the transmitter is expected to deliver. The output of the filter, on the other hand, may have to work into a high-impedance point in the antenna system; hence a double-spaced condenser is used at  $C_2$  to handle the higher voltage in such cases. Both condensers are mounted on porcelain insulators. The coils, again

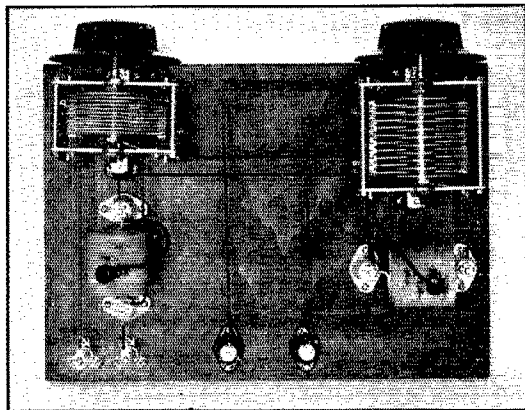

**THE ANTENNA-COUPLING FILTER**  
The antenna coupler, matched in design to the other transmitter units, functions as described by Collins in February, QST.

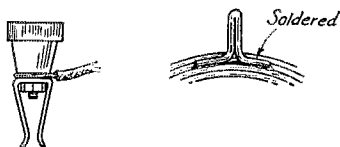

**FIG. 3—DETAILS OF THE INDUCTANCE CLIP CONSTRUCTION AND METHOD OF MAKING COIL TAPS**

of construction similar to that used for the oscillator coils, are tapped every five turns. The method of making the taps is shown in Fig. 3. A short piece of bare wire, bent as shown, is soldered directly to the turn to be tapped, after the insulation has been scraped off the latter, of course. In soldering, both the bared turn and the tap should be tinned separately and then sweated together without additional solder. This method helps prevent shorting the adjacent turns. The soldering should be done as quickly as possible, because

prolonged heating of the coil may char the celluloid base.

The insulated "clip," the construction of which is also shown in Fig. 3, consists of a jaw taken from a miniature knife switch, the handle being the top of an old binding post. A machine screw of suitable length is first run firmly into the binding-post top, then the head of the screw is clipped off and the assembly fastened to the switch jaw with a small nut. The connecting wire is fastened between the jaw and handle. The resultant clip is positive, easy to handle, has plenty of contact surface and is neat in appearance.

The input terminals of the antenna coupler are, as before, on the rear right corner of the baseboard. The antenna terminals are at the rear center.

#### TUNING THE AMPLIFIER

In describing the oscillator last month a temporary method of coupling to the antenna was suggested.

This is discarded, because the oscillator now is to work into the grid circuit of the amplifier. Since coupling directly from the plate of the oscillator to the grid of the 841 (through the coupling condenser,  $C_1$ ) overloads the oscillator, it is necessary to reduce the load by tapping the oscillator plate coil. The oscillator output circuit has accordingly been changed slightly, and the circuit now appears as in Fig. 4. One of the output terminals is connected to the "ground" point

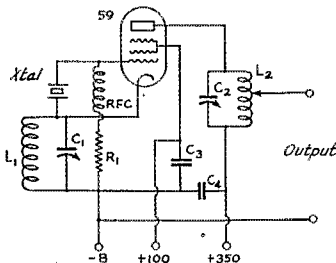

**FIG. 4—THE REVISED OUTPUT CONNECTIONS OF THE OSCILLATOR ARE SHOWN IN THIS DIAGRAM**

Except for the tap on  $L_2$  and the connection between one output post and the negative "B" lead, the diagram is the same as given in March, QST.

(negative "B"), and the other to the tap on the plate coil. The number of turns between ground and the tap will be approximately 70% of the total number of turns on the coil. The tap and clip are constructed in the same way as those for the antenna coupler.

With the oscillator output terminals connected to the amplifier input terminals (tap on oscillator coil going to the condenser  $C_1$  in Fig. 1), plate and filament power should be applied to the oscillator and its circuits adjusted to resonance. The method is the same as previously described in March *QST*, except that the setting of the oscillator plate condenser for resonance probably will differ slightly because of the added capacity across the coil when the grid circuit of the amplifier is connected. When this adjustment is completed a neon bulb touched to the 841 grid should glow. An appropriate plate coil for straight amplification should be inserted in the amplifier plate circuit at  $L_1$ . Disconnect the plate voltage, but have the 841 filament lighted. Then, with  $C_6$  set at zero, turn  $C_6$ , holding the neon bulb to the plate of the 841, until the bulb glows, indicating that the plate circuit is in resonance. Then increase the capacity of  $C_6$  in very small steps, each time retuning  $C_6$  and the oscillator plate tuning condenser to resonance, until it is impossible to get any signs of r.f. in the plate circuit of the 841. The tube then will be neutralized. Providing the specifications for  $L_1$  for various bands have been closely followed, the tube will remain neutralized for all bands without necessity for touching the neutralizing condenser when the coils are changed.

After neutralization, plate voltage may be applied to the 841 with a milliammeter of 0-100 or 0-200 range connected in the positive plate supply lead. Adjust  $C_6$  to resonance, indicated by dip to a minimum plate current of 15 or 20 milliamperes, assuming a plate supply of approximately 500 volts. When this has been done, the amplifier is ready for connecting to the antenna coupler and antenna.

Adjustment of the antenna coupler will depend upon the frequency and the type of antenna used. These adjustments are not difficult to make, but the correct settings for  $C_1$  and  $C_2$  and the taps on  $L_1$  and  $L_2$  (Fig. 2) will have to be determined experimentally. For balanced output (two-wire feed), approximately half the turns will be used in each coil on 7 mc.; on lower frequencies more turns will be required and on higher frequencies, fewer. Changing a tap will also require a change in the settings of the condensers. The adjustment which gives the greatest antenna or feeder current for a given amplifier plate current will be best.

Experience with the unit confirms that the process of tuning the coupling filter is as described in the Collins article previously referred to.<sup>3</sup> In brief, having made a selection of taps which looks reasonable, and with  $C_2$  at half scale, swing  $C_1$  to give minimum plate current on the amplifier. If

the minimum plate current is higher than it should be, try another tap and repeat the process. Then adjust  $C_2$  for maximum output consistent with the plate current desired. The amplifier plate tuning condenser should not be touched during this procedure. After the tuning is completed, the amplifier tank condenser can be turned experimentally to see if the antenna coupler has affected its resonance setting. If the resonance setting changes, indicated by a new setting for minimum plate current on the tank condenser, the antenna-coupling adjustments have not been made correctly. When the coupling is "right," the resonance setting of  $C_6$  will be exactly the same either with or without the antenna coupler connected.

The amplifier coupling coil,  $L_2$  in Fig. 1, is an expedient which avoids tapping the plate coil  $L_1$ . The number of turns on  $L_2$  determines the extent to which the amplifier can be loaded. Experiment indicates that the number of turns on  $L_2$  should be approximately 35% of the number on  $L_1$ . In individual cases, a turn or so at a time can be added or subtracted to make the amplifier take the desired plate current under load. To secure maximum power output, the right number of turns on  $L_2$  can be determined quite readily if a 25-watt lamp is connected to the antenna coupler output posts and used as a dummy antenna. The number of turns which gives maximum lamp brilliance is correct.

As an illustration of the way the coupler works, although probably not applicable to more than one case, the settings for  $C_1$  and  $C_2$  were approximately 10 and 30, respectively, on a 100-division scale, with 10 turns each in  $L_1$  and  $L_2$ , for coupling the amplifier into a Zepp antenna with quarter-wave feeders on 7 mc.

#### VOLTAGES AND POWER

Although the 841 amplifier is intended to be the intermediate stage in a three-stage transmitter, it can itself work as a final amplifier of fair power output. With 500 volts and 60 to 70 milliamperes on the plate, a power output of approximately 20 watts is easy to secure on those bands on which it operates as a straight amplifier. In using the 841 as a doubler to 14 mc. when a 3.5-mc. crystal is used in the tri-tet oscillator, the output is in the vicinity of 8 watts with the same plate voltage. No particular improvement in power output seems to result from the use of a 7-mc. crystal, although this might not be true in the case of a very active plate.

The power output is sufficient for excitation of a 50-watt stage on 14 mc. (and likewise enough for low-power work on that band) and more than enough on the lower-frequency bands. A plate voltage of 450 to 500 volts is, therefore, all that is needed when the tube is to be used as an exciter for the 830 amplifier to be described in a coming issue. Higher plate voltage can be used, of course,

(Continued on page 74)

# A Simple Cathode-Ray Oscilloscope

## Its Construction and Use in Ham Phone Checking

By James Millen, W1HRX,\* and Dana H. Bacon, W1BZR\*\*

**M**OST amateurs, and particularly those interested in 'phone transmission, recognize the cathode-ray oscilloscope as an extremely useful piece of apparatus which makes it possible to get the utmost out of a short-wave transmitter. Until just recently, however, such equipment has been both complicated and expensive, the latter item particularly preventing the amateur from enjoying its advantages. Recently, however, cathode-ray type tubes have appeared on the market at cost no higher than a medium power transmitting tube, and with this tube as a basis, simple oscilloscope apparatus which will answer almost any question arising in the adjustment or operation of an amateur transmitter has been made possible.

It is the purpose of this article to describe and show how to use such a unit, the outstanding features of which are its simplicity, compactness and low cost, and which will do practically everything that the more complicated oscilloscope will do. The

correct mounting position, one transformer should be taken at a time, the other being wired in the circuit but placed two or three feet away, where the field will have no effect. The correct position is determined as follows: With the tube in operation and the focusing control  $R_2$  adjusted to give a clear spot, the 60 cycle sweep circuit is put in operation on the horizontal deflection plates. The potentiometer,  $R_1$ , is adjusted so that the beam traces a line about  $1\frac{1}{2}$  inches long. If this line is straight and has the same intensity on each side

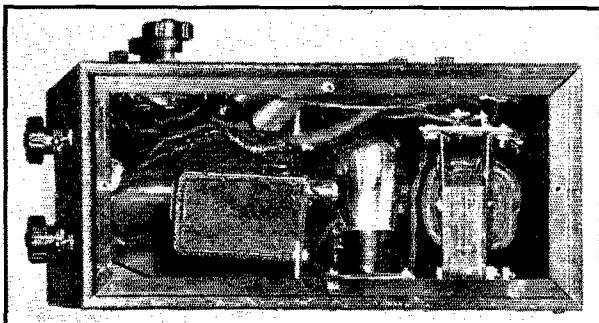

Left—Top view of the compact oscilloscope unit. Resistors and switches are conveniently mounted on the front and sides of the case which is 6 inches wide, 8 inches high and 12 inches deep.

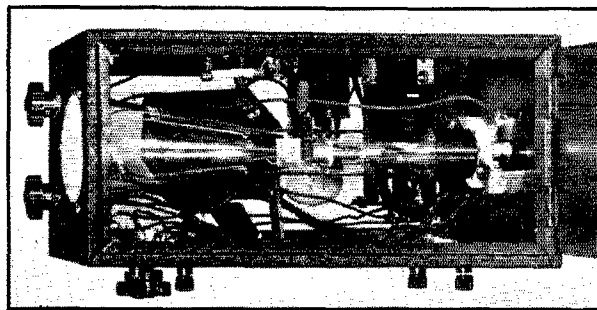

Above—Bottom view of the assembly, showing the transformers and rectifier tube. The transformers are placed to eliminate magnetic influence on the electron beam, as described in the text.

circuit is shown in Fig. 1, while the various photographs show the arrangement of the parts in the experimental model.

Although the construction of such a unit is really simple, one precaution, in particular, must be observed: *the tube must not be placed so that the alternating magnetic field from either of the transformers has any effect upon the electron beam.* It is not difficult to mount the transformers in such a way that this is avoided. In determining the

of the center, all well and good; if not, the transformer must be twisted around in different positions until one is found where the line is clean and straight. The other transformer may now be placed in the oscilloscope cabinet and the procedure repeated. The transformers should, of course, be rigidly mounted after their positions have been determined.

One other precaution, especially important where the oscilloscope is to be used for checking a powerful transmitter, is to prevent stray r.f. voltages from getting into the supply circuits via the a.c. line. Usually two 0.01- $\mu$ f. condensers ( $C_1$ ), connected in series across the line with the midpoint grounded to the cabinet, will be completely effective. In some cases, however, it may be necessary to increase the size to 0.1  $\mu$ f.

\* 84 Autumn St., Malden, Mass.

\*\* 41 Bellington St., Arlington, Mass.



the operator is likely to misinterpret irregularities which may be present in it. For instance, if the positive r.f. peaks are too flat, the trouble may be caused either by insufficient r.f. excitation to the modulated stage, overload in the modulator circuit, or both. Such confusion does not arise when observing the trapezoidal pattern.

#### USING THE OSCILLOSCOPE

The diagrams of Fig. 2 show how the oscilloscope is connected to different types of modulators. Note that in all cases the voltage for

which is tuned to the transmitter frequency and is placed near the oscillograph. The deflection plates are then connected to the tank circuit terminals.

If there is r.f. present in the modulator output circuit, it will be impressed upon the horizontal deflection plates and the vertical line will have the appearance of a cylinder. The same effect might possibly be obtained by incorrect adjustment of the focusing controls, but if their readjustment does not clear up the line, r.f. is present. It can usually be filtered out by the addition of a

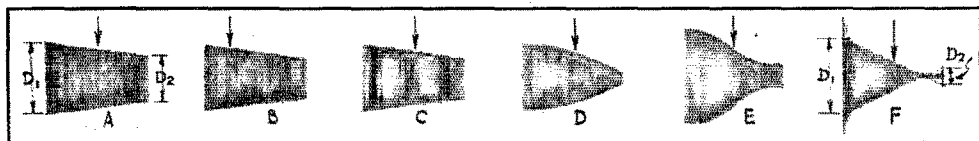

FIG. 3—SKETCHES OF TYPICAL TRAPEZOIDAL FIGURES REPRESENTING VARIOUS OPERATING CONDITIONS

The normal trapezoidal figure obtained with a medium degree of modulation is shown by "a". The modulation percentage is obtained by measurement of the dimensions  $D_1$  and  $D_2$ , and substituting in this simple equation:

$$\text{Percent modulation} = \frac{D_1 - D_2}{D_1 + D_2} \times 100$$

Output containing even harmonics is represented in B; and C is typical of odd-harmonic content. Flat-topped positive peaks of the modulation envelope, as would occur with insufficient Class-C amplifier excitation, are represented in D, while E shows this condition combined with distortion of the negative peaks. In F we have that old bear, over-modulation, with the negative peaks cut off and with "whiskers" on the positive peaks. Arrows indicate carrier position without modulation. Further explanation of these figures is given in the text.

horizontal deflection is taken from the final audio circuit; that is, the point where the Class-C amplifier supply lead is connected. *This is very important.* Do not attempt to supply the horizontal deflection plates from some other part of the speech circuits, for the audio voltage at any intermediate point may be out of phase with the actual modulating voltage, resulting in a weird pattern which has little meaning.

With a dummy antenna substituted at the transmitter output, r.f. voltage is coupled to the vertical deflection plates by means of a 3-inch diameter pick-up coil, consisting of a few turns of wire. This coil is placed near the Class-C tank circuit and the coupling adjusted so that the vertical deflection on the screen of the tube will, in the absence of modulating voltage, be a line about an inch long. The line should have the same intensity and length above and below the center. Even with the transmitter circuits in perfect adjustment, the r.f. line may be brighter at the top than it is at the bottom, or vice versa. The bright portion will probably be longer than the dim portion. This phenomenon *may* be entirely normal; in fact, it is to be expected with a single-ended r.f. amplifier working into a heavily loaded low-C tank circuit, where the "excited" side of the r.f. cycle is apt to be much stronger than the other side. In order to obtain a symmetrical r.f. voltage for the vertical deflection plates, the leads of the pick-up coil should be coupled loosely, link-circuit fashion, to an additional tank circuit,

small by-pass condenser, shown by the dotted lines in Fig. 2. The leads connecting the oscillograph with the modulator may pick up a small amount of r.f. but this seldom causes trouble, provided they are not more than a few feet long.

After a suitable vertical (r.f.) line has been obtained, speaking or whistling in the microphone should cause the trapezoidal pattern to appear. If the vertical line stretches out into a band, the audio voltage on the horizontal sweep is too great, and should be reduced by means of the control,  $R_1$ , or by an external voltage divider.

When the modulator is functioning properly, the pattern will spread out an equal distance on each side of the original r.f. line (Fig. 3A). If it doesn't, there is distortion from even harmonics (2d, 4th, 6th, etc.) in the modulator circuits. Such distortion might be caused by passing excessive Class-C amplifier plate current through the secondary of a Class-B modulator output transformer, or from an overloaded modulation choke having a saturated core. There are, of course, many other possible causes of even harmonic distortion; for instance, unbalanced tubes in a Class-B modulator; all of which will make the trapezoid shorter on one side of the vertical center line than on the other.

Third (and higher odd-) audio harmonics are, unfortunately, not so apparent. They show up as one or more vertical bands having greater brilliance than other nearby parts of the pattern, and are clearest close to the wide end of the figure

(Fig. 3C). This type of wave cannot be detected when second harmonics are also present, as the latter may cause similar vertical bands.

Regardless of the fact that various harmonics may be present in the audio output of the modulator, the upper and lower edges of the trapezoid should be straight lines. If they show any curvature whatever, the characteristic of the Class-C amplifier is not linear.

Before progressing further, it might be well to consider the source of the audio signal. As mentioned above, whistling or talking in the microphone will produce the pattern, but unless the operator has good lungs and an exceptionally steady whistle, the dimensions of the trapezoid will be constantly varying, making accurate measurements difficult. It is much better to apply a steady, controllable, audio signal to the speech amplifier, preferably from an audio oscillator having good wave form and variable frequency. This would be ideal, as the operator would then be able to determine the overall frequency characteristic of his equipment, excepting the microphone. The next best arrangement is to take a.c. from the line, step it down to a few volts, and connect it, through a potentiometer, to the speech amplifier. By varying the a.c. input (or speech amplifier gain) the operation of the transmitter may be studied in detail at different percentages of modulation.

#### INTERPRETING THE PATTERNS

When the oscilloscope is set up with both audio and r.f. sweeps working properly, the modulation should be increased slowly until the triangular pattern is obtained indicating 100% modulation. If everything is working perfectly, the Class-C plate current will not change, the antenna current (in the dummy antenna!) will increase 22% and the modulator tubes will not be overloaded. In all probability, however, the picture will look more like Fig. 3D. This shows a flat-topped r.f. wave caused by an incorrectly adjusted Class-C amplifier. The operator should remember that flat-topped audio wave cannot possibly cause the upper and lower sides of the triangle to be curved; so, for the present, forget about the audio signal.

The most common cause of this type of curvature is insufficient excitation to the Class-C stage. This may be checked by detuning the preceding stage slightly and watching to see if the curvature increases. If it does, more excitation must be supplied to the Class-C amplifier, although occasionally decreasing its bias will straighten things out. Possibly the buffer has insufficient excitation. Flat-topped positive peaks also are sometimes present when a Class-B modulator and the Class-C amplifier are operated from a common power supply of poor regulation, although usually in this case the negative peaks are distorted also (Fig. 3E). Flat positive peaks will appear in a Class-B linear r.f. amplifier if the

preceding Class-C stage is not properly loaded, or if the average excitation to the linear is too high. This is the result of the grid load of the linear being greatest on the positive peaks. Often-times an increase in the Class-B linear's bias will reduce the load enough to straighten the characteristic; but when doing this, watch out for distortion on the negative side.

The oscillograph shows up over-modulation very definitely, as indicated in Fig. 3F. When the modulation exceeds 100%, the r.f. voltage falls to zero and remains there over an appreciable portion of the negative cycle, producing a line on the screen which extends beyond the tip of the triangle horizontally. There are also high amplitude r.f. transients on the positive peaks and although these are hard to see, because they do not remain stationary long enough, they are the cause of the "burps" and "gurgles" which cover so many kilocycles on each side of the offending 'phone carrier. The transients are not so noticeable on the negative peaks, because the Class-C plate voltage is zero during this part of the cycle, although they sometimes appear as a slight fuzziness on the extending horizontal line.

The percentage of modulation may be easily and accurately determined from the formula given with Fig. 3A. It should be calculated only, however, when the upper and lower sides of the pattern are straight, and when the modulation is less than 100%. To determine the degree of over-modulation, the upper and lower sides of the triangular pattern must be extended, as shown by the dotted lines in Fig. 3F.  $D_2$  will then have a negative value.

It is suggested that the operator adjust the transmitter so that the test signal is modulating it just under 100%, carefully noting meter readings which may serve indirectly as operating checks on the percentage. The plate current of a Class-B modulator gives a good indication, while the antenna current change is a poor last choice.

Now disconnect the test signal, connect the microphone, and start talking, at the same time trying to watch both the oscillograph and the meter. It will be found that the peaks of the

(Continued on page 80)



The Madrid treaty does not become effective until ratified, and then only between the nations that have ratified or acceded to it. At this writing in late February the United States has not yet ratified. While various foreign governments have approved the radio regulations attached to the Madrid treaty and have in fact put them into effect, the only formal ratification of the convention of which we have heard to date is that of Belgium, which also covers the Belgian Congo and Ruandi-Urundi.



# Improving the Freqmeter-Monitor

## The Construction of a Selective, Electron-Coupled Unit

By D. A. Griffin, W2AOE\*

**T**HE great majority of amateurs is familiar with the electron-coupled oscillator and its application to frequency measurement work. To combine it with a listening monitor, or more properly to make the frequency meter serve in a dual role, has already been done. The purpose of this article is to describe further development work enabling the amateur to make a combination "freqmonitor" that will give even better results.

When the simple electron-coupled oscillator is used as a monitor as shown in Fig. 1, we find that the signal level is generally weak. This is true for several reasons. First, the tube is not a good detector when it is busy oscillating rather strongly; and second, the impedance match between the plate circuit and the headphones is poor.

During the past year or two, a number of freqmonitors have been described in *QST*, employing a separate detector tube as shown in Fig. 2. This is a distinct improvement over

Those amateurs who have such meters are aware of one difficulty with this arrangement, especially if they are operating on 7 or 14 mc. with a multistage transmitter. When the key is up, the oscillator and unkeyed doublers or buffers set up a loud signal. When the key is pressed, putting the final stage into action, only a slight increase in signal strength occurs. The result is that the signal sounds like one of the long-wave compensated alter-



Above-base assembly with the tubes removed, showing the oscillator coil at the left, tuning condenser in the center and padding condenser at the right.

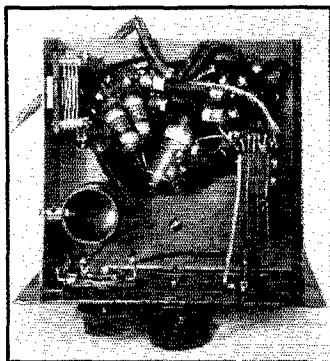

Below the base, showing the detector input coil behind the selector switch on the panel, with the fixed air condenser near the back. At the other side is the telephone jack.

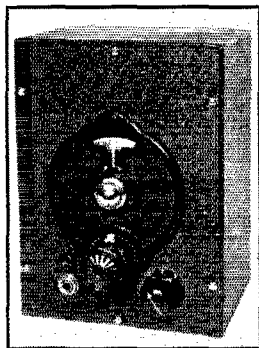

PANEL VIEW OF THE IMPROVED FREQMETER-MONITOR

R.f. coupling pin jack and phone jack to the left of the tuning knob, detector input coil switch to the right.

handling large signals and of giving a correspondingly large audio output. Then too, its plate impedance matches that of headphones very satisfactorily.

\* Leeds, 45 Vesey St., New York, N. Y.

nators, and is not particularly pleasant to listen to.

The reason for this becomes apparent if we refer to Fig. 2. The detector input circuit is untuned. The signal voltage in the headphones is produced by the input to the detector from the e.c. oscillator and that

the one-tube job. For one thing, we can put a husky signal from the transmitter into the detector grid via a coupling wire, without over-loading. Also, the 56 tube is an excellent detector capable of handling

coupled in from the transmitter on the pick-up wire. If the oscillator is on 3.5 mc., the voltage input to the detector on this frequency is large. When it beats with the relatively small amount of voltage picked up from the 80-meter crystal oscillator, the resultant signal will also be quite large. The 7-mc. harmonic of the e.c. oscillator is much weaker, but the first doubler may be putting out a stronger signal on this frequency than the crystal is on its fundamental. Now if we have a final amplifier on 14 mc., its effect will not be much greater even though the output is much larger than that obtained from the other stages because the stronger signal from the final amplifier beats with the relatively weak fourth

harmonic of the oscillator. In other words, we are maintaining a fairly average signal whereas we want to discriminate against everything but the signal from the final amplifier.

The solution of the problem is shown in Fig. 2, showing the complete circuit diagram of the improved freqmeter-monitor.

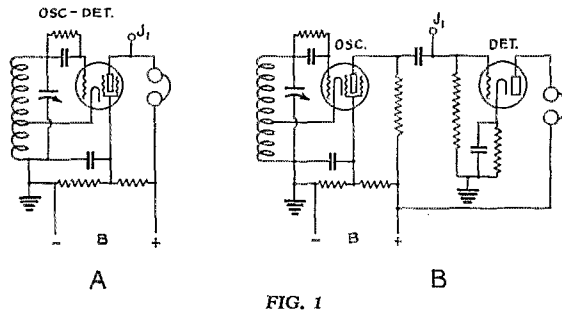

FIG. 1

The idea is to provide particular selection for the frequency to be monitored. The grid circuit of the detector is roughly tuned to 3.5, 7 or 14 mc., by means of the fixed air condenser and tap switch on the coil. By throwing the switch to the proper point, we can make the detector more sensitive to the one band we desire, rejecting to a large extent the signals from both transmitter circuits on the other bands. On 1.7 or 3.5 mc., we can use the full coil for listening to the second harmonic and fundamental, respectively. On 7 mc., by throwing the switch to make the circuit resonant at that frequency, the "key down" signal will be far louder than the "key up" signal. The size of the pick-up wire can also be reduced to further accentuate the difference in signal strength. The same procedure is followed when operating on 14 mc.

The use of the tapped coil will also increase the strength of the harmonics from the oscillator when the instrument is used as a frequency meter. Care should be taken, however, that the switch is thrown to the 7- or 14-mc. position, when the meter is being calibrated or used to measure frequency on those bands. In the 3.5-mc. position the load of the tuned circuit on the oscillator causes a slight frequency shift which, of course, must be avoided.

Aside from the introduction of the tuned grid circuit, the arrangement is conventional electrically and does not require exhaustive explanation. The oscillator tuned circuit covers the 3.5-mc. band. Since the dial spread per kilocycle is somewhat greater than that of a 1.7-mc. meter in so far as the harmonically related portion of the spectrum is concerned, readings on 7 mc. and 14 mc. will be considerably more accurate—assuming the meter to be accurately calibrated.

The apparatus for the oscillator is all mounted

on top of the sub-panel as shown in the photograph. A 270-degree condenser is employed for the tuning and an enclosed 75- $\mu$ fd. midget for padding. This latter condenser can be adjusted to locate the band on the dial properly. The new National Type BX dial, with readability to 0.1 of one division, puts a minimum amount of weight on the condenser shaft. A ten-to-one dial ratio, together with scale illumination and a 270-degree scale, make precise setting of the instrument easy. With the constants used, the 3.5- to 4-mc. band takes up 140 of the 150 divisions, so that the meter may be read to 350 cycles.

The tapped detector grid coil and fixed air condenser are mounted underneath the sub-panel as close to the tap switch as possible. The necessary resistors and by-pass condensers form a "blob" of gadgets to be sure, but short leads and solid mounting of apparatus come first in construction if best results are to be obtained.

The owners of two-tube instruments can readily put the tuned grid circuit into their meters, since the necessary apparatus takes up very little additional room. The only point to bear in mind is that the coupling condenser  $C_5$  should be of the

(Continued on page 61)

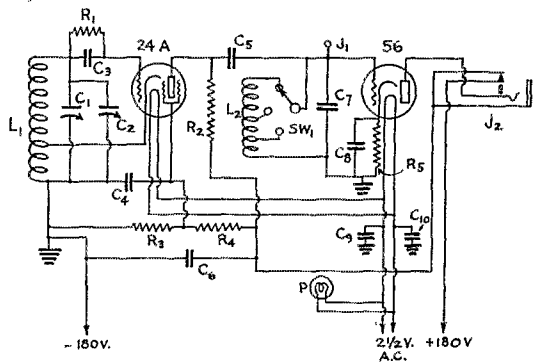

FIG. 2—CIRCUIT OF THE FREQMETER-MONITOR

- $L_1$ —Oscillator coil; 42 turns No. 20 d.s.c. close-wound on 1-inch diameter form, cathode tap at 14th turn from ground end.
- $L_2$ —Detector grid coil; 26 turns No. 26 d.s.c. on 1-inch diameter form. Tapped at 4th turn for 14 mc. and at 12th turn for 7 mc.
- $C_1$ —Oscillator tuning condenser, 25- $\mu$ fd. max. (National SEU-25).
- $C_2$ —Oscillator padding condenser, 75- $\mu$ fd. midget (National W75).
- $C_3$ —Oscillator grid condenser, 100- $\mu$ fd. mica.
- $C_4$ ,  $C_9$  and  $C_{10}$ —0.01- $\mu$ fd. r.f. by-pass condensers.
- $C_5$ —Oscillator coupling condenser, 40- $\mu$ fd. mica.
- $C_6$  and  $C_8$ —0.1- $\mu$ fd. by-pass condensers.
- $C_7$ —Detector input tuning condenser, 50- $\mu$ fd. air.
- $R_1$ —100,000-ohm  $\frac{1}{2}$ -watt fixed resistor.
- $R_2$  and  $R_6$ —100,000-ohm 1-watt fixed resistors.
- $R_3$ —3000-ohm 2-watt fixed resistor.
- $R_4$ —50,000-ohm 2-watt fixed resistor.
- $J_1$ —Pin jack, insulated from panel (r.f. coupling).
- $J_2$ —Open-circuit telephone jack with control circuit to break B supply.
- P—2.5-volt dial light.
- SW $_1$ —Single-section three-position coil switch.

# H A M D O M



WHEN Commander Hawks entered hamdom, he reconverted an old backslider and pulled David Grimes in with him. Dave Grimes has achieved an affectionate fame in the hearts of thousands of set-builders with his Inverse Duplex and other circuits, but these achievements are comparatively modern in the light of the little known fact that he beat the Radio Act of 1912 in entering the amateur game. It was the war that wooed him away from us to green commercial



David Grimes

fields; first, with A. T. & T.; then as chief engineer of the old Sleeper concern; as president of his own Grimes Radio Engineering from 1926 to 1929, and currently as engineer in charge of R.C.A.'s patent department laboratory. W2GKM came into existence in August, 1933, primarily to gain first-hand knowledge of 56-mc. phenomena and to test with Hawks en flight in his famous speed plane. Transmitter development has been limited by the fact that the budget was also called upon to provide an accordion, another lifelong suppressed desire, which now blankets New York City almost nightly on 60 mc. It's hard on the boys, but if it keeps Dave Grimes back in hamdom, we're for it.

FROM owner of a Ford spark coil set to chief of the Air Navigation Development Section, W. E. (Bill) Jackson has followed the radio trail. Ex-WICMP, -W2AHM, -W3HF, at different times employee of General Electric, working on oscillators, high-frequency c.c. transmitters, directive radio range beacons, and operating 2XAF, and of RCA at Rocky Point, assisting in the development of h.f. receivers, transmitters, transmission lines and beam antennas for transoceanic communication. In 1927 he joined the



W. E. Jackson

Airways Division of the Bureau of Lighthouses, designing, developing, and inspecting radio equipment. When this division was taken over by the Aeronautics Branch, he was promoted to chief of the Development Section. In between stretches of riding the air lanes, he still listens in avidly to his old pals of the ham fraternity.

IN AMATEUR radio we call it the Delta Division. More literal-minded, the Gulf Refining Company takes its name directly from the Gulf of Mexico, a region where it thrives. Marvin M. Hill, W5EB and director of the A.R.R.L. Delta Division, works under both names, for he is also head of the Gulf wholesale distributing organization in Natchitoches, La. With a radio career starting in the spark-coil stage in 1919, promotion was quickly achieved to a 1-kw. spark and the call 5EB in 1920. A 5-watt c.w. rig accompanied him through three years of dormitory life during a course at Louisiana College, from which he graduated in 1924. The next five years found him occupied as a high-school science

teacher and athletic coach, from which position he resigned to take over the oil business. He served Louisiana as S.C.M. in 1928-29, and was elected director in 1930.



Marvin M. Hill

He is W.A.C. and O.R.S. Another flying director, Hill is a licensed pilot and owns a plane which he uses for business and pleasure.



Benjamin F. Borsody

IN 1911 an E. I. Co. "Bulldog" spark coil went on the air on Avenue A and 55th Street. It was powered by a storage battery supply, used on the side to light electrically the family apartment, and periodically lugged to the Bowery on the First Avenue horse car for re-

(Continued on page 74)

# Amateurs of Assistance in Emergencies

## Notes on Recent Work Accomplished

### California

**L**A *Crescenta-Montrose Flood, Dec. 31st-Jan. 1st:* During the night of December 31st and early morning hours of January 1st, heavy floods descended upon La Crescenta and Montrose, California, carrying away bridges, houses, automobiles, telephone and telegraph lines, and causing the loss of several lives. W6EAH, 3.9-mc. 'phone at La Crescenta, was on the air handling emergency traffic, news reports, etc. W6EAH and W6FCE were the operators. A few facts about the storm: Total rainfall, 13 inches; known dead, 38; missing, 60; homes demolished, 400; property damage, \$5,000,000. Late afternoon of the 31st, W6FCE, Pasadena, in charge of the Los Angeles County Sheriffs' amateur radio emergency net (Eugene Biscalluz, sheriff, sponsor), sent out a request for information on storm conditions. Reports were received from amateurs all over Los Angeles County. W6EAH reported conditions very bad in Montrose, with the check dams bulging from the water pressure, and stated that trouble was expected. W6FCE and his YF started at once for Montrose to be of whatever assistance might be necessary.

Upon getting on the air at W6EAH it was learned that conditions were bad in Glendale, whereupon it was decided to go there with the idea of setting up a portable transmitter should same be necessary. This trip consisted mostly of dodging boulders, which ranged in size up to two feet in diameter. Finding things under control in Glendale, a return trip was made to the Montrose sheriff's office where W6EAH's address was placed on file in case telephone lines went out. En route from the office to W6EAH's shack, real trouble was encountered. W6FCE tells the story: "We were stopped by Flood Control workers, who said it was too dangerous to cross a washout some two hundred feet across. A truck went through, however, and finally they changed their minds and thought we could get through. Two men were out in front of us to guide, and I was steering and taking instructions from W6EAH when he saw a great wall of water coming some six to eight feet. He advised me to put the car in low gear and head straight for it, or the water would rush across the road and turn us over. So we met it head on. One of the Flood Control workers jumped on the hood of the car; the other was washed away, never to be found. The water rushed over the top of the car; out went our

lights. We could feel the car being pushed back rapidly. Water started up through the floor boards and the car came to a stop. The rocks were hitting the car windows with terrific force. I was thankful we had shatter-proof glass throughout! We finally managed to open the doors and jump out into the raging torrent. It carried us I don't know how far until it spread out and left us knee deep. The rocks and boulders were still coming, knocking us down as we struggled along. We finally found shelter at a house that had not been washed away. Regaining our breath we returned to the sheriff's office only to find water covering the entire building and all lights out. Telephone lines were out to Los Angeles. Our thoughts now were of our wives, whom we had left at W6EAH's shack."

After a most dangerous trip W6FCE and W6EAH managed to get back to W6EAH's home

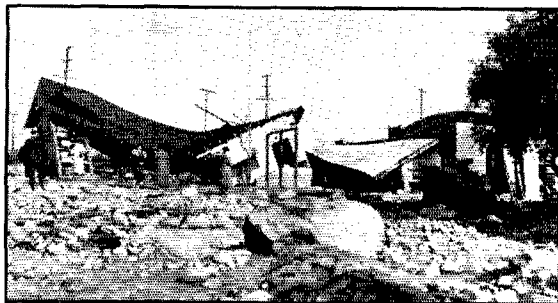

A TYPICAL SCENE AFTER THE FLOOD  
The ruins of a church in Montrose, Calif.

to find everything OK. Following a hasty breakfast W6EAH went on the air. At 8:00 a.m., January 1st, the first QRR was sent. A message received from the Los Angeles sheriff's office read in part: "The amateurs are proving to be a wonderful asset. Fine work. We are proud of you." A total of eighty-three messages, not including news reports, were sent. W6EAH was on the air until late that night when 'phone service was restored. In Montrose W6IIA set up a portable 1.7-mc. 'phone in a radio store and cooperated with relief workers, contacting W6DSP, Glendale, who also did good work assisting the authorities. W6ABF, Los Angeles, and W6CKR, Van Nuys, 3.9-mc. 'phones, maintained contact with W6EAH. Other stations giving valuable cooperation in this emergency include W6CNE, W6BGC, W6EFD, W6EUP, W6EP, W6GYE, W6GNM, W6DDA, W6GIQ, W6GVM, W6FRL, W6AOT, W6ASK, W6CJK, W6EQI and

W6JWY. The night's experience cost W6FCE the loss of a new "Chevy," which he found on the morning of the 2d a total wreck alongside the road where Flood Control workers had towed it.

## Canada

*Swains Lake, Ontario, in January:* A man lay near death with acute appendicitis. Word reached G. A. Coutanche, VE3BO, operator at the Ontario Forestry Branch radio station at Swains Lake. Unable to get word through on commercial channels, VE3BO turned to amateur radio, contacting Joe Sky, VE3HA, Fort William. Sky immediately wired the Canadian Airways at Sioux Lookout. A 'plane carrying a doctor was shortly headed for Swains Lake. An emergency operation was performed and the man's life saved!

*Gaspé Peninsula, Quebec, January 30th:* Two crack express trains imprisoned in snowdrifts as 50-mile-per-hour gale swept the worst winter storm in quarter of century before it. Communication systems disrupted. Dr. J. Landry, VE2BA, was Mont Joli's sole means of communication from mid-afternoon on the 29th. VE2BA, upon contacting Rev. C. E. Robert, VE2EC, Three Rivers, reported the westbound express from Maritimes blocked by the storm at Amqui, and the eastbound express from Montreal in the drifts at St. Simeon, and sent many other details of the tie-up.

*Hudson Bay Region, January 14th:* A group of Canadian flyers, believed lost in the Hudson Bay region, had not been heard from for over three weeks. Then on Sunday morning, January 14th, W2CSM, with Arthur A. Ozsvath and Robert Kapp at the controls, was called by VE2IC, Port Harrison, Hudson Bay. W2CSM received a message for the Montreal Airways stating that all hands were safe in Port Harrison, a small trading post near which they had been forced down. Ozsvath 'phoned the message to Montreal and was advised that this was the first word received from the missing flyers! A plane left Montreal at once, and rescue was thus effected.

## Northwest

*Idaho, in December:* Wallace and Kellogg, Idaho, were isolated for several days due to bad floods. W7AQK (Kellogg) and W7BDX (Wallace) did praiseworthy QRR work, providing their isolated communities with communication. Both stations used 'phone. W7VS, Portland, Oregon, copied press from W7AQK (through VE4MG). W7BCU, Weiser, Idaho, and W7BEV, Spokane, Washington, took much traffic from W7AQK. W7DKY, Boise, and W7KV, Portland, were also active, ready to cooperate if the opportunity afforded. Coöperation of other operators in the 'phone bands made effective work by W7AQK and W7BDX possible for a number of days.

*Spokane, Washington, December 22d-27th:* W7AMA, station of Henry Sturtevant, Spokane, was on the air for six days providing emergency communication with isolated areas. Operators were: Naval Reserve—W7AFC, W7CKR, W7AKL, W7BGN, W7CHU; Others—W7HS, W7CLR, W7ASN, W7DRY, W7ADU, W7NV, W7DQF, Herman Logan, Tex Taylor (ex-W9FAB), and Bonde Tuveson. Nearly all are members of Spokane Radio Operators' Club. Most all work was with W7BDX and W7BZU, Wallace, Idaho. W7BZU consisted of equipment loaned by the Spokane Radio Co. This equipment and an operator, Carl Johnson, were flown to Wallace. W7BZU and W7BDX divided the load at Wallace, working together in every detail. Practically all work was on 1.7- and 3.9-mc. 'phone, with some little contacting being accomplished on 3.5-mc. c.w. A total of approximately 936 messages and news reports were handled by W7AMA. A. P. reports 4256 words received via W7AMA. Press dispatches addressed to *The Chronicle*, Spokane paper, totalled about 8000 words. Numerous weather reports were exchanged between Spokane and Wallace. Other stations coöperating include W6CRX, W7BIW, W7DRK, W7BOF, W7HR, VE4NN, W7BBK. W7BEV, station of Roland I. Smith, Spokane, did work with W7AQK, Kellogg, Idaho, paralleling W7AMA's with W7BDX and W7BZU.

*Oregon-Washington, December 17th:* A raging storm on the Oregon-Washington coast . . . ships torn from piers . . . sea rushing over dikes and highways . . . a steamer blown aground . . . all normal means of communication in many places out . . . Army Amateur Radio System on the job. W7AYV, Astoria, Oregon, handled traffic and press from his isolated city. W7WR and W7AXJ/WLVP kept things organized at Portland. W6RJ/WLVA advised WLM/W3CXL of conditions. WLM promptly informed other corps areas, and a national A.A.R.S. emergency set-up was made available to the isolated districts. Traffic and press was handled nightly until advice from W7AXJ on December 19th that "Lines now OK to Astoria, storm subsiding." Then at about 9:30 a.m., on Christmas Day, a slide and washout about 25 miles east of Astoria again destroyed all communication! At 10 a.m. the telephone company at Portland asked W7AXJ to get a message through to the wire chief at Astoria. This was accomplished through W7WR's schedule with W7CXX, Seaside. A reply was received fifteen minutes after communication was established. Traffic was handled for S. P. & S. R. Co., Western Union, United Press and Pacific Tel. and Tel. Co., as well as many incidental messages. W7CXX handled traffic to Astoria via W7CEO, who did excellent work. Others assisting in the emergency include W7AYV, W7BWS, W7COU,

(Continued on page 80)

# How to Get Those Foreign QSL's

An Explanation of the A.R.R.L. QSL Forwarding System—New District Managers for the 1st, 3d, and 4th U. S. Districts and Canadian 2d District

AS MANY members of the A.R.R.L. are already aware, the League maintains as one of its membership services a free QSL-card forwarding service by means of which QSL cards (mostly foreign, but including domestic when necessary) are delivered to American amateurs. This service was first announced in the March, 1933, *QST*, page 29, and further notes (particularly regarding Canadian service) appeared in an article on page 34 of the August, 1933, *QST*. Amateurs who may have access to those issues are referred to them for further information, although the system will be explained briefly in this short article for the benefit of new hams who may not be familiar with the details of the system.

Briefly, the service is built around nine volunteer District QSL Managers for the United States, there being one for each inspection district, plus five similar managers for the five Canadian districts. The names and addresses of these District Managers are listed herewith, it being called to the attention of those already familiar with the system that a number of districts are now in charge of new managers:

- W1—Allen W. Jones, W1NW, 1626 Commonwealth Ave., Boston, Mass.
- W2—H. W. Yahnel, W2SN, Lake Ave., Helmetta, N. J.
- W3—R. E. Macomber, W3CZE, 418 10th St., N. W., Washington, D. C.
- W4—B. W. Benning, W4CBY, 520 Whiteford Ave., Atlanta, Ga.
- W5—Shelton Stanton, W5ACA, 2627 Milan St., New Orleans, La.
- W6—C. E. Spitz, W6FZQ, Box 1804, Phoenix, Ariz.
- W7—L. Q. Kelly, W7BPC, 4919 So. Prospect St., Tacoma, Wash.
- W8—F. W. Allen, W8GER, 324 Richmond Ave., Dayton, O.
- W9—H. C. DeMuth, W9FJB, 1411 Dempster St., Evanston, Ill.
- VE1—J. E. Roue, VE1FB, 84 Spring Garden Rd., Halifax, N. S.
- VE2—Stan Comach, 1088 Egan Ave., Verdun, P. W., Canada.
- VE3—Bert Knowles, VE3QB, Lanark, Ont.
- VE4—Dr. J. J. Dobry, VE4DR, Killam, Alberta.
- VE5—E. H. Cooper, VE5EC, 2024 Carnarvon St., Victoria, B. C.

Now, as to how the system works. Every active amateur who is interested in receiving the QSL cards due him should immediately despatch to the QSL Manager for his particular district one stamped, self-addressed envelope. Make sure the envelope has the necessary first-class postage. Send only one envelope, to the manager of your district only. This envelope should be self-addressed by you, having your full name and address in the usual place. Your call (and this is highly important) *should be printed prominently in ink in the upper left-hand corner of the face of the envelope*. In order to make it easier for the QSL Managers to maintain the system, it is earnestly requested that a standard-size envelope known as No. 8 be used (9½" by 4½"). Anything smaller than this is too small for many of the cards that will be received for you, and anything larger makes it difficult to establish a uniform file. Please cooperate by furnishing a No. 8 envelope.

After you have sent your QSL Manager the envelope (making sure it has your call in the upper left-hand corner, that it is correctly addressed, and that it has full first-class postage) the system will work without further action on your part. When we, here at League Hq., receive a batch of foreign QSL cards—and we receive thousands each month—we sort them and send all first-district cards to the QSL Manager for the first district, all second-district cards to the Second District Manager, etc. They have already filed your envelope with others, alphabetically by calls, and when they receive a batch of cards they insert any that may be for your call into your envelope. When the envelope has enough cards in it to bring it up to the weight limit of the postage provided (sooner than that if cards aren't coming in for you very fast) they take out your envelope, seal it, and drop it in the mailbox. Whenever you get a batch of cards from your QSL Manager, you should immediately shoot him another similar envelope to take the place of the one just used.

And that's all there is to it.

A few comments are in order before we close. First, we want to express our deep appreciation for the work of W1VP, W3CQS, W4ATZ and VE2BO, who were until recently the QSL Managers of their respective districts but who now find it necessary for one reason or another to turn the work over to their successors. They have performed noble work, and many hundreds of amateurs will join with us, we know, in thanking them for their year's toil. FB OM's!

(Continued on page 88)

# Master Control Station NDM\*

## A Description of Typical Naval Reserve Equipment

By Lieutenant-Commander E. C. Rogers, U. S. N.\*\*

**N**AVAL RESERVE RADIO STATION NDM, located in the Navy Yard, Philadelphia, Pa., is one of a group of twenty-nine similar radio stations throughout the United States, Puerto Rico and the Canal Zone, these stations making up the backbone of the Naval Communication Reserve network. The United States is divided into Naval districts for the purpose of administration, each district having a master and one or more alternate control stations for communication work. NDM is the Master Control Station for the Fourth Naval District which comprises the states of Pennsylvania, Delaware and the southern half of the state of New Jersey. The Alternate Control Station in this District is NDC, located at Pittsburgh, Pa.

The mission of the Naval Communication Reserve is to obtain and train communication ratings for the United States Navy for a national emergency and these master and alternate control stations are the means provided by the Navy for this purpose. All master and alternate stations are equipped by the Navy and the equipment of all is practically the same as that at NDM.

The photograph shows the layout at NDM. To the left is the 150-watt transmitter which is either crystal controlled or self-excited. Just to the right of the transmitter is the landline which connects NDM to the District Communication Office in the Navy Yard, and in case of emergency, this landline can be thrown on to the Navy leased landline which runs from Washington, D. C. north to Boston, Mass. The regular telegrapher's position is to the left of the picture but it can be plugged in at the operator's

position, should only one operator be available. The receivers to the right of the transmitter in the order shown are: high frequency; low frequency; intermediate frequency and ultra-high frequency. These receivers are able to cover a continuous band from 10 to 401,000 kc., with three receivers covering the amateur bands. The desk in the foreground is the supervisor's position which is equipped with both receiver and transmitter controls. The plug board seen mounted on the back of this desk enables any receiver to be connected with any position or with a group of six "listening-in" positions, to the left. The watch officer's desk is in the inboard right-hand corner of the room and is equipped with receiving and transmitting controls. This desk cannot be seen in the photograph.

NDM is operated entirely by personnel of the Headquarters Unit which comes directly under the Communication Reserve Commander for the district. All the members of this unit

are licensed amateurs. This unit is commanded by Ensign William M. Uhler, C-V(S), U.S.N.R. (W3AKY). Other members of the unit are: Ensign Robert W. Lafore, Unit Executive Officer; CRM E. N. McCullough (W3ABQ); CRM H. B. Stein (W3CL); RM1c J. W. Callaghan (W3DZ); RM1c J. C. Hargraves (W3FY);

RM1c A. W. Kurz (W3BNF); RM2c F. C. Baxter (W3ID); RM2c C. E. Keener (W3AJS); RM3c G. J. Quick (W3AZF); RM3c J. D. Angeny (W3ABZ) and RM3c R. A. Ledward (W3DHS). These men are divided into squads, and the squads take turns at operating the station, hence at the time the photograph was taken not all of the men were present. Those shown in this photograph from left to right are: RM3c Ledward, Ensign Uhler, RM1c Callaghan, RM1c Hargraves, CRM McCullough, and sitting at the desk in the foreground is CRM Stein.

The antenna transfer switch shown in the upper left center is a combination transfer and grounding switch. In order to get maximum



NDM IN FULL SWING

\* All opinions or assertions contained in the foregoing article are the private ones of the writer and are not to be construed as official or reflecting the views of the Navy Department or the Naval Reserves at large.

\*\* Commander, Naval Communication Reserve, Fourth Naval District, Building No. 29, Navy Yard, Philadelphia, Pa.

efficiency from the transmitter a separate antenna is used on each of the two Naval Reserve frequencies, 3475 and 4015 kc. The switch shown permits the transmitter to be thrown to either of the antennas or can be disconnected from them. Both antennas can be grounded through the vertical switch which can be seen in the photograph.

NDM also operates under the amateur call W3GX, generally on 3610 kc., the District's amateur frequency. NDM is on the air every Thursday night for National drill, and every Sunday morning from 11:00 to 12:30 for local drill, both on 3475 kc. The personnel of the unit feel justly proud over the comment made by Lieutenant Commander W. J. Lee, U.S.N.R., Naval Reserve Liaison Officer, in a recent inspection report to the Chief of the Bureau of Navigation, upon the completion of his inspection trip, in which he states: "The quarters, equipment and facilities of this Reserve station (NDM) are second to none in the United States." All the work in connection with installation of the equipment has been done by members of the unit.

NDM plays its part in emergency communications, being manned several times by Reserve personnel in the past year for this purpose. In connection with the Akron disaster a continuous watch was placed on NDM on a special circuit with the Naval Air Station, Lakehurst, N. J. Over this circuit a large amount of traffic was handled, same being forwarded via the landline to the Navy Yard Communication Office. At no time has any difficulty been experienced in obtaining sufficient personnel from the Naval Communication Reserve for manning NDM in these emergencies, whether it be for only a few hours or for several days. In this connection it should be borne in mind that this service is rendered by the men of the Naval Communication Reserve without any compensation whatsoever, and it is this spirit, typical of the Naval Communication Reserve, that is making the organization into an efficient and valuable asset to the Navy.

### A Single-Tube Short-Wave Converter

(Continued from page 13)

A glance inside the midget broadcast receiver, which we used much of the time, showed that power supply leads were in a very accessible position. The drain of one more tube certainly would not seriously overload the power supply. Hence, final work was done with the common power supply with no detectable difference in results. If the common power supply is contemplated the heater voltage used on the tubes in the broadcast set will determine whether a 2A7 or 6A7 is going to be used. Otherwise, the choice will be with the individual constructor and the particular power supply available.

### OPERATION

After a final check in wiring, the converter is ready for work. It should be placed close to the intermediate-frequency amplifier or broadcast set with which it is to be used so that the leads will be short and direct. Disconnect the antenna and ground from the broadcast set and connect at the proper terminals on the converter. Then run a short twisted pair of wires from the converter output to the antenna and ground posts on the broadcast set, making sure that the grounded side of the converter output connects to the receiver ground terminal. If the converter is feeding directly into the 450- or 465-kc. i.f. amplifier of receiver, take off the grid clip of the first i.f. stage, and connect the ungrounded lead from the output of the converter to the grid of the first i.f. stage. In either case the output of the converter must be tuned to the amplifier it is being used with.

With feed into the antenna circuit of a broadcast receiver, the dial should be set at about 600 kc. With the gain control advanced fairly well and with the converter turned on its side, the shielded midget condenser is adjusted to tune the converter output circuit to the frequency of the receiver. This is done with any set of coils in place. But be sure the coils are in their proper sockets, the detector coil at the left and oscillator coil at the right. As the i.f. tuning approaches resonance, the background noise in the speaker will rise until there is a definite peak, either of background hiss alone or of signal if the converter happens to be tuned on a signal. This adjustment is permanent providing the receiver frequency is not changed.

### TUNING

If the oscillator coils have been pared as given in the table, the detector padding condenser will track at least approximately with the oscillator padding condenser over the entire range of each set of coils. The band setting is done with the right hand or oscillator padding condenser and the detector condenser is tuned to resonance (same setting on the knob as its twin) and all tuning done with the main dial or band-spread condenser.

While the converter as it now stands is primarily for voice reception, much code practice can be obtained at about any spot in the spectrum. This is especially true of commercial stations with their modulated signals. For beat note c.w. reception, an i.f. beat oscillator, of equally simple construction could be made up from the information given in April, 1933, *QST* or *The Radio Amateur's Handbook* (Eleventh Edition). This will complete the receiver and give the constructor an excellent superhet for all-round operation.

With good tuned r.f. broadcast receiver chassis on the market at low prices, after they have attained the age of two years (or so), this seems to

(Continued on page 74)





### Improving the Performance of the Voltage-Fed Hertz

By C. Chapin Cutler, W1TX\*

RECENTLY I had some difficulty in making the usual form of voltage-fed antenna, shown in Fig. 1A, work satisfactorily. I should like to make known a personal discovery concerning it.

The theory of operation of this circuit is based on the fact that a free oscillating tank "assumes" a ground point at the center due to the capacities

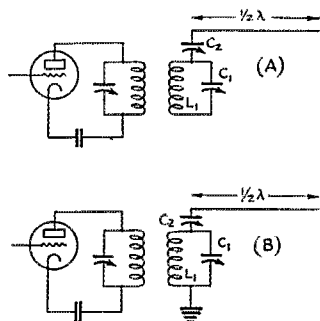

FIG. 1—THE CONVENTIONAL METHOD OF COUPLING A SIMPLE HERTZ ANTENNA TO A COUPLING TANK (A), AND AN IMPROVED ARRANGEMENT (B) WHICH PERMITS BETTER POWER TRANSFER

of the tank to ground, provided that these capacities are equally distributed. Thus, with the center of  $L_1$  at ground potential there is a voltage between either end of  $L_1$  and ground. Therefore, an antenna could be voltage fed from either end of  $L_1$ . However, coupling the antenna to the tank in this manner would offset the capacities to ground, because of the ground capacity of the antenna, and thus move the "assumed" ground point nearer the end of the tank, so that the voltage feed into the antenna would be small and this method would be inefficient for coupling, as in reality is the case.

The ideal condition for most efficient operation using this method would be to have the ground point and the antenna coupling point at opposite ends of the circuit, as this would give the maximum voltage feed to the antenna. The impedances would be well matched, as the impedances of both a resonant tank and an antenna at this

\*Worcester Polytechnic Institute, Worcester, Mass.

point are extremely high. The only way possible to obtain this condition is actually to attach a ground to one end, as in Fig. 1B. The antenna now takes on the appearance of a Marconi instead of a Hertz, but it must be remembered that a resonant tank has very high impedance and high voltage instead of low impedance and low voltage, as is necessary for feeding a Marconi.

As there is practically no current flowing no special ground is necessary, a steam radiator or a water pipe being sufficient. In tuning this arrangement, best results are obtained when  $L_1$ , very loosely coupled to the transmitter and with ground connected, is first tuned to resonance by  $C_1$ . Next, the coupling is increased until the proper load is obtained. The antenna is then connected and tuned by a series condenser or loading coil to get minimum current circulation in  $L_1C_1$  or to get maximum current indication near the center of the antenna. It is impossible to tune by current at the end of the radiator because there is so little current that ordinary instruments cannot detect it (about 30 mils for 35 watts). It is also impossible to tune the antenna itself by the plate current of the vacuum tube, as the antenna changes affect the oscillator itself very slightly.

It is quite obvious that any current fed system, instead of being useless on even harmonics, can be made to work very efficiently as a voltage-fed antenna simply by tuning the pickup coil to resonance with the r.f. output by a parallel condenser. It is not necessary to connect a ground in this case as the capacities balance.

I experimented with this system at W1BIH's portable location in Worcester, Massachusetts, and results were all that one could wish for. Before the ground was connected, W1BIH and I called about twenty-five stations and worked only one. With the ground connected we worked an average of three out of four called, with excellent reports. Incidentally we were using a half-dead 10 at the time, and the antenna had a 90° bend near the middle.

#### Tapped-Coil Detector With Filament-Type Tubes

The following letter from John M. Everitt, R. D. No. 1, Ridgewood, N. J., gives further information on the use of two-volt tubes in the version of screen-grid feedback circuit which maintains the screen at ground potential for r.f.†

†"Since the tapped-coil detector circuit for d.c.

tubes was shown in the December, Experimenters' Section, a number of readers have written to me for further details and suggestions. Most of their troubles were apparently with the filament choke.

"The diagram of Fig. 2 shows a fool-proof

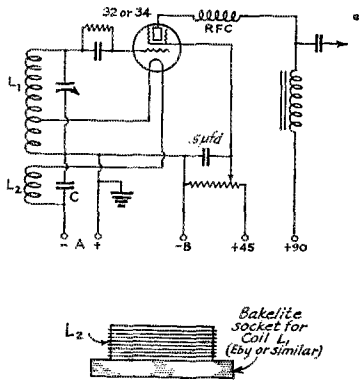

FIG. 2—DETECTOR CIRCUIT WITH CATHODE TAP AND FIXED FILAMENT COIL FOR USE WITH FILAMENT-TYPE TUBES

Circuit values are usual for regenerative receivers. Data on points at which  $L_1$  should be tapped are given for coils of various sizes in the text. The coil  $L_1$  consists of 10 or 12 turns of small wire (about No. 30) wound around the coil socket, which must be of the type having an extruded top. Condenser C is 0.05  $\mu$ fd.

method of obtaining the feedback. It is self-explanatory, but I will give the location of the tap for a few representative coils:

Turns in total winding	Tap, turns from bottom
3	$\frac{1}{2}$
6	1
15	1
30	$2\frac{1}{2}$
60	$3\frac{1}{2}$
90	6

If a plate by-pass is used, slightly less turns below the tap should be employed.

"There is no difficulty in reaching 5 meters, but above about 10,000 kc. a Type 32 should be used instead of the 34 tube, because of the internally connected suppressor in the latter. On the lower frequencies, however, the 34 gives considerably greater output.

"I have been using the circuit with a stage of t.r.f. and a '30 audio amplifier for some time with very pleasing results."

The chief point of interest in the circuit is of course the fixed coil  $L_2$  in the return filament leg. This coil should be wound in the same direction as  $L_1$ , and the lead from the filament should go to the upper terminal of the winding. The voltage induced in  $L_2$  from  $L_1$  keeps the return leg of the filament at the same r.f. potential as the leg connected to the tap on the detector coil.

### Increasing I.F. Selectivity by Regeneration

It is well known that regeneration in the i.f. amplifier is very effective in improving the selectivity of a superhet receiver. Here is probably the simplest way of introducing the regeneration. It is as effective as any method if control of the selectivity is not necessary.

My own receiver has two stages of i.f. at 450 kc., using 58-type tubes. The first step was to take the first i.f. stage off the gain control and ground the cathode through its 400-ohm bias resistor. Then I took a piece of insulated pushback wire about 4 inches long and twisted one end around the control grid cap. The rest of the wire was then placed next to the tube down inside the tube shield. The grid-plate capacity of the tube was increased enough to make it oscillate. I then cut off about  $\frac{1}{4}$ -inch of wire at a time till the tube was just below the oscillation point. It was then necessary to rebalance the i.f. amplifier.

Result — the receiver now tunes about twice as sharply as it did before. The quality of 'phone signals suffers somewhat because of cutting of the side-bands, but as far as I am concerned the width of the ham 'phone bands has been doubled.

It is important that the gain control does not act on the regenerative stage; otherwise the setting of the gain would affect the selectivity.

I believe this little stunt is worthy of a few lines in *QST*. It is a haywire arrangement, of course, but it certainly does the business—and has the advantage of requiring the purchase of no parts nor the expenditure of any great amount of time. In my particular case I was forced to something like this because the construction of my i.f. transformers is such that it would be very difficult if not impossible to mount a tickler coil next to the grid coil.

—Earl I. Anderson, W8UD, Douglas, Mich.

### On the Pentagrid Superhet

Milton Smith, W9NRK, suggests the addition of a 50,000-ohm resistor to the beat oscillator circuit of the superhet receiver described on page 12 of the August, 1933, issue of *QST*, in cases where trouble with this oscillator has been encountered. The revised circuit is given in Fig. 3.

Before putting in this resistor, adjusting the beat oscillator frequency for maximum response caused the detector to howl, in W9NRK's case. The 50,000-ohm resistor cured this.

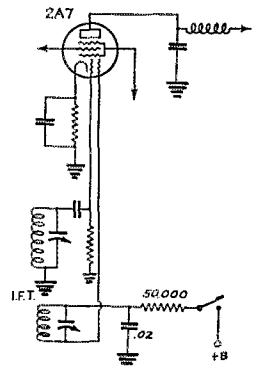
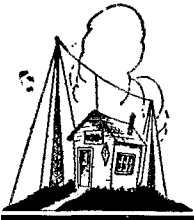

FIG. 3



# Amateur Radio STATIONS



## W3BEI, Haddon Heights, N. J.

NOT long after the re-opening in 1919 the merry falsetto of a Ford spark coil announced the arrival of Walter Filson, 3BEI, on the air. The original Ford outfit grew up to an Amrad and later into a 1-kw. (nominal) spark with a Bell gap, an outfit which gathered in seven of the nine districts before it was made obsolete by the more efficient, if less impressive, tube equipment. Many things have transpired since those days, but the accompanying photograph shows that W3BEI has kept pace with the times.

The transmitter rack at the right holds all the power supplies and controls as well as the transmitter itself. There are three stages in the set; a 47 crystal oscillator, 10 doubler or buffer, and a 211 final amplifier. Each stage has its own power supply, and there is a fourth power pack delivering "C" bias. The filament and plate power to each stage are controlled separately by the switches on the panel, in addition to the "master" switches by which the whole transmitter is controlled in ordinary operation. Each stage is metered separately. The space between the row of tuning dials and the feeder tuning apparatus at the top of the panel is now in the process of being filled with a separate 160-meter 'phone transmitter. Sitting on top of the rack is a frequency meter using a Rectox rectifier and a 1.5-mil d.c. meter as a resonance indicator.

On the operating table are the keys, a Hammarlund Comet Pro, a monitor, and a heterodyne frequency meter, a dynatron which is regularly checked from Standard Frequency Transmissions. A calibration chart of ample size is tacked on the wall at the left, just over the cabinet which houses a broadcast receiver. The latter is ar-

ranged so that its output amplifier can be connected to the s.w. receiver, and is also fixed up for playing records and for making recordings of ham signals.

The antenna now in use is a 136-foot Zepp with 45-foot feeders. With this outfit all continents except Asia have been worked, several cards reporting the reception of W3BEI's signals in Asia indicate that a WAC is well within possibility. The layout brought 2d prize in a club contest held recently.

W3BEI holds appointments as O.O. and O.R.S., and at one time was a District Superin-

tendent under the old Communications Department scheme of organization.

## W7BB, Seattle, Wash.

IN THESE days of innumerable amateur stations and universal DX, few hams can make names for themselves on the air in the way that outstanding stations did in the early '20's. Yet despite the keen competition a handful of stations has achieved reputations through consistently good work over a long period. We all can name them, and we all will agree that one of the prominent members of the "40-meter gang" is W7BB. The man behind the key at W7BB is Edwin R. Stevens, of 915 N. 13th Ave., Seattle, Wash.

W7BB made its first appearance on the air in February, 1926. The transmitter at the time was a UV-202 in the old reliable t.p.t.g. circuit. The station has changed many times since, having used at various times 203-A's, 852's and even a five-kw. water-cooled tube. The present arrangement has proved to be the most satisfactory, and

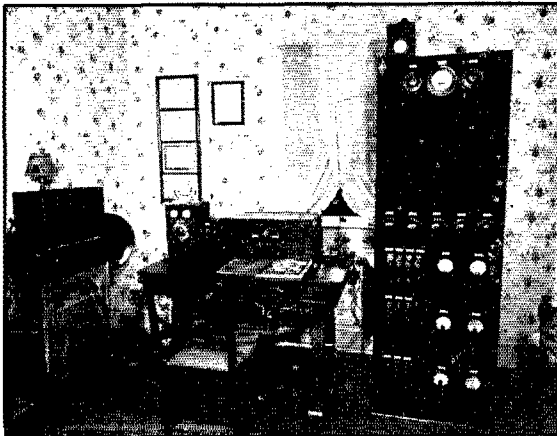



RECEIVING POSITION AT W7BB

the transmitter has not been altered for nearly a year. And no changes are contemplated.

Stevens has owned and operated a number of amateur stations, among them NA7AP, K6CB, YS1AP and old C9BG. A number of shore and ship jobs has also been held, but the owner's interest at the time is strictly amateur.

W7BB is located on the top of Capitol Hill, the highest point in Seattle. It is an excellent spot for antennas and the one in use at present has been used since early in 1928. Various types have been tried but the present system, for all around effectiveness, outperforms the various Zeppelin and Hertzian types. It is a fifth harmonic Marconi, 330 feet long, suspended between a thirty-foot stick on top of the shack to a sixty-five-foot pole three hundred feet away. Incidentally, this antenna, for receiving purposes, is better than any type of tuned receiving antenna tried.

The transmitter uses a 47 oscillator on 3.5 mc., doubling to 7 mc. through a 46. A 211 serves as a buffer and two 204-A's in push-pull make up the final. Link coupling is used and the 204-A's operate with a kilowatt input. Battery bias is used throughout. The transmitter operates on 7008, 7022 and 7037 kc. requiring but a few seconds to change frequency.

The receiver is an FB7A. Stevens inclines to the detector and audio variety, but the presence of two stations in the same block, both working 7 mc., made a "super" necessary. The Marconi antenna is used for the majority of the time but a doublet with transposed feeders is used at intervals. The re-

ceiving doublet also has proved very effective for use as a transmitting antenna when contacts with South America are desired.

W7BB's main interest lies in rag chewing and DX, although some considerable traffic has been handled. More than eighty countries have been worked on 7 mc.

## VE2HM, Montreal, P. Q.

THE accompanying photograph is a view of VE2HM, the station of W. C. J. Meredith, 1228 Pine Ave., West, Montreal, P. Q. The transmitter is a Collins 32-B, having a 47 oscillator, 46 buffer, and two 46's in parallel in the amplifier stage, with Class-B modulation. On top of the transmitter is a Collins 2A unit designed to match the input impedance of the antenna to the output impedance of the transmitter and also to eliminate radiation of harmonics. (This system was described in February *QST*.—Ed.) Two transmitting antennas are used, one a 40-meter Zepp, used for 20- and 80-meter work, and the other a 268-foot single-wire-fed Hertz for use on the 160-meter band. The receiver is an FBX. On the

righthand side of the desk are the keys and key-click filter system.

On the left edge of the table are a standby switch, a switch for grounding the transmitter chassis when desirable, and a two-way switch by which one pair of 'phones can be connected either to the receiver or to the monitor. Alternative power supplies for the receiver are below the

operating table. The two vertical wires behind the right of the table are indoor receiving antennas, used because local QRN conditions make an outdoor receiving antenna unsatisfactory. A gain control unit and shielded microphone battery box

(Continued on page 86)



THIS 1-KW. TRANSMITTER SIGNS W7BB



VE2HM, 160-METER PHONE

---

---

# • I. A. R. U. NEWS •

---

---

Devoted to the interests and activities of the  
**INTERNATIONAL AMATEUR RADIO UNION**

President: H. P. MAXIM

Vice-President: C. H. STEWART

Secretary: K. B. WARNER

Headquarters Society: THE AMERICAN RADIO RELAY LEAGUE, West Hartford, Conn.

## MEMBER SOCIETIES

American Radio Relay League  
Associazione Radiotecnica Italiana  
Canadian Section, A.R.R.L.  
Československi Amatérí Vysílací  
Deutscher Amateur Sende-und-Empfangs  
Dienst  
Experimenterende Danske Radioamatører  
Liga Mexicana de Radio Experimentadores

Nederlandsche Vereeniging voor Internationaal Radioamateurisme  
Nederlandsch-Indische Vereeniging Voor Internationaal Radioamateurisme  
New Zealand Association of Radio Transmitters  
Norsk Radio Relæ Liga  
Polski Związek Krotkofalowców  
Radio Society of Great Britain  
Rede dos Emissores Portugueses

Reseau Belge  
Reseau Emetteurs Français  
South African Radio Relay League  
Suomen Radioamatööriyhdistys  
Sveriges Sandareamatörer  
Unión de Radioemisores Españoles  
Union Schweiz Kurzwellen Amateur  
Wireless Institute of Australia  
Wireless Society of Ireland

---

Conducted by Clinton B. DeSoto

### National:

While basically correct in its explanation of the derivation of the new call letters of Spanish amateurs from the old call numerals, the discussion of the new Spanish system appearing in this department of the January, 1934 issue of *QST* gives an incorrect result to the example quoted. In working it out, we overlooked the fact that Spanish amateurs are divided into nine districts, and therefore the counting must be chronologically by districts, instead of straight-forwardly from 1 to 200-something. Thus, EAR12, while the twelfth in number among all the stations of Spain, is actually the fourth in the Madrid district (the others are EAR1, 10, and 11), and therefore the assignment should be EA4AD, rather than EA4AL. (Actually, Uriarte, formerly EAR12, has been assigned EA4AE, but this is an error and we are informed will soon be changed.)

On February 1st a new call system went into effect in Japan, removing from the Tokyo district the distinguishing prefix J1, and causing all Japanese amateur stations to be assigned the prefix J2. The new Tokyo district calls start at J2GA. Among the new assignments we have received word concerning the following: J1DO is now J2GX; J1EC is now J2HG; J1EE is now J2HI; J1DM is now J2GW; J1DP is now J2GY. The Tokyo group, by the way, have organized a Tokyo Amateur Radio Club with the motto, "Be more active on the air." They welcome requests for schedules, to fill out that last DX QSO for WAC, and the like. Write J2GX (exJ1DO).

The membership of the U.S.K.A. has now reached the 200 mark, 40 members being active transmitters. This advance accompanies a recent liberalization of the regulations in Switzerland, the postal authorities having doubled the 3.5 mc.

assignment, granting 200 kc. in this region, as well as opening up the entire 56 mc. band. A weekly broadcast on society matters and traffic notices is given on 3.5-mc. 'phone by HB9Q, in German, and HB9AR, in French.

---

### QSL:

Corrections to the QSL Bureau list appearing in the February issue of *QST* are as follows:

The correct address for the R.S.G.B. is 53, Victoria St., rather than 52 Victoria St. The R.S.G.B.'s QSL section is managed by Douglas Chisholm, G2CX. It handles cards for all parts of the British Isles, and offers an express direct service to all British Empire societies.

The QRA for the new agency for Iraq is as follows: J. H. Knowles, Esq., W/T Section, Squadron 70 B.T.R.A.F., Hinaidi, Iraq.

All VQ3, VQ4 and VQ5 cards can be sent to W. Gray Manson, Esq., Ubiri Estate, P. O. Lushoto, Tanganyika.

There is only one active station in Palestine at the present time, ZC6CN, operated by C. C. Newman, No. 2 Armored Car Co., R.A.F., Ramleh, Palestine. Cards for any stations starting up there in the future can be sent to ZC6CN.

Cards for Ceylon can be sent to G. H. Jolliffe, VS7GJ, Frocester, Govinna.

---

### General:

The first Fisk Trophy competition in Australia resulted in the victory of the Victoria division, with a score of 3951 . . . . The highest individual score was VK7CH's: 1383 . . . . H. D. Collin, G2DQ, won the R.S.G.B.'s 1.7-mc. transmitting contest, with G6FN and G2KV runners-up . . . . For the benefit of those

who missed its mention some months ago, we reprint the limited operating hours observed by Japanese amateurs: 2-4 a.m., 6-8, 10-12, 2-3 p.m., 4-6, 10-12 . . . . From 6-8 EST in the morning and 4-6 in the afternoon are the best times for W QSO's . . . . YV2AM, Maracaibo, Venezuela, is on 7145 kc. with 'phone from 8:00 a.m. to 10:00 a.m. EST Sundays . . . . A distress call from a Russian ship in danger of being cracked in the ice near Wrangell Island was heard on 7 mc. by Eric W. Trebilcock, BERS195 . . . . The ship stayed afloat, but so far as is known is still ice-bound . . . . The R.S.G.B. hopes to pass the 2000 mark in membership any day now . . . . British Empire members, other than those in the United Kingdom, total 235 . . . . Paul de Neck, president of the *Re-seau Belge*, has turned the editorship of *QSO* over to a newly organized committee . . . . G. Pollart, ON4BY, is the new editor; M. Cosyns, B9; R. DeLoor, ON4SA; J. Mussche, ON4BJ; R. Verstrepen, ON4AA; G. Janssen, ON4BZ; G. Neelmans, ON4FT; L. Pecher, ON4RO; Stoefs, ON4RE; L. Richard, ON4UF; P. C. Moies ON4PM; L. V. Rubeck, ON4ZQ; J. Mahieu, ON4AU; M. Koninckx, ON4VKV and P. Turlot, ON4EL, are committee members . . . .

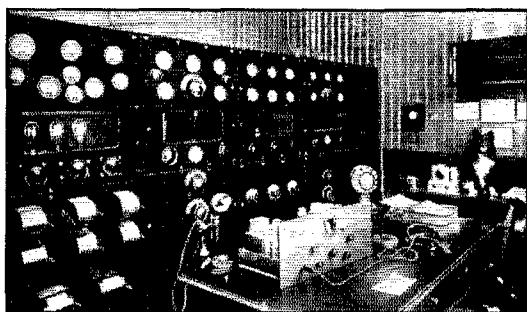

LU2CA, ANGEL RADAELLI, PARAGUAY ST. 2233, BUENOS AIRES, ARGENTINA

WAC, 54 countries, 491 W stations, 'phone to all South American countries, W, ON, J, ZL, —this record has been made with a 204A final modulated by two 203A's in Class B.

is Q, indicating the quality of the signal. The proposed scale:

- Q1 A.c. of a frequency higher than 60 cycles.
- Q2 A.c. of a frequency between 16 and 60 cycles.
- Q3 Unfiltered R.A.C.
- Q4 Poorly filtered R.A.C.
- Q5 Fairly well filtered R.A.C., nearly D.C.
- Q6 P.D.C., but not as good as C.C.

Q7 A.C., or unfiltered R.A.C., but C.C.

Q8 Fairly well filtered R.A.C., C.C.

Q9 Pure D.C. crystal controlled.

If Q1-6 are unsteady, they can be reported as "Q5 chirpy," or "Q3 QSX"

While most countries now make D.C. notes compulsory, there is still a wide field for such a scale as this. Reactions concerning its utility will

be appreciated. Already in use in Europe, many amateurs seek its universal adoption. Your comments will be helpful.

-----  
**"First":**

Last month we reported a change in the long-standing *QST* account of the first Canadian-British working, more than ten years ago. This month we have no correction to report, but instead we have an invitation.

Ten years ago Charles York, then operating 7HG in Tacoma, worked a station with the call JUPU, purporting to be a ship operator in a Japanese port, using a ham set. Other than the actual QSO, no acknowledgment was ever received from the operator; no more is known now than was known ten years ago concerning the authenticity of the contact. Was JUPU actually a ship near Japan, or was it someone next door playing a practical joke with a buzzer?

Can anyone tell? Can anyone advance any other information as to who was probably the first to work across the Pacific, ten years ago? These questions are our invitation, to anyone who knows the answers.

**Strays**

VE4IY suggests using a wooden embroidery hoop for the Zepp universal joint described in the February Experimenters' Section. With a thorough boiling in paraffine and a few shallow notches to hold the wires, the hoop has all the necessary features. Be sure to pick out a husky one, though.

-----  
**Tone:**

A contribution has been received from the European RCC conveying a suggestion by Zdennek Vaclavik, OK2SI, concerning a revision of the T-scale, or note classification scale.

OK2SI maintains that the existing scale errs in that it does not give the pitch or relative frequency modulation in the proper order. T2, for example, "rough 60-cycle a.c.," is presumably broader than T1, which is simply 25- or 60-cycle tone. T5, also, with its chirps and thumps will give rise to more frequency modulation than the r.a.c. of T4, especially if the latter is applied to an amplifier properly controlled. By the same token, T7, with thumps, is worse than T6, which is steady although slightly tone modulated.

The new scale is based strictly on tone. No provision is made for ill-treated notes, with key thumps, back wave, etc. These can be described in different language. The tone scale refers solely to the character of the emitted wave from the standpoint of modulation imposed upon it. Instead of using the prefix letter T, the one used

# THE COMMUNICATIONS DEPARTMENT



F. E. Handy, Communications Manager  
E. L. Battey, Assistant Communications Manager

## Connecticut Stations Organized for A.R.R.L. 20th Anniversary Relay\* April 7th-8th

**E**IGHTY-SIX Connecticut stations will be on the air on every active amateur band during the A.R.R.L. 20th Anniversary Relay (see details elsewhere in this issue). These stations, with frequencies scattered throughout each band, will be constantly on the look-out for traffic addressed to President Maxim. Their hours of operation are so diversified that no one should have difficulty in relaying traffic into Connecticut at any time during the period of the Relay. Every A.R.R.L. member is to answer President Maxim's message by radiogram. SCM Ellis, WICTI, says, "Let the traffic come. Connecticut is ready!" The calls of all Connecticut amateurs that have pledged their cooperation are here listed by frequency bands so that they may be easily recognized when heard on the air. In the case of the more "thickly populated" bands, stations are classified according to "portions" or "segments" of these bands in which they intend to operate. Connecticut stations will be on April 7th, 8th, and 9th. Their complete schedules will be sent by bulletin to the whole A.R.R.L. field organization.

**1715-2000-KC.**

PHONE: W1DSV EDL GXU HVB.

**3500-4000-KC.**

3500-3633: WIADW BDI CDZ CVL DBP/YU DCP DFT DGG DMK DMP DOV ERU ES GC GME GTV GTW/GTX HNF HPI MK NI QP TD UE.

3633-3766: WIAKI BFS BIC FXQ GGM GUC HAG HIR KV.

3766-3900: WIAFB AMG APW BDI BHM BIQ BMP BSS BWM CJD CTF CUH DBU DCM DJC DOW EAO EFW ERU ES EWD FIO FMY FUM GKM GTO HAX HJW HOP HPI HTS MK UE VB.

3900-4000 PHONE: W1BIC BNR SZ.

**7000-7300-KC.**

7000-7150: WIAFB AGT BDE CEG CKF CLH CSC DF DFT DOV FFW FTR GCX HSU MK NI SZ TS.

7150-7300: W1BEQ CNU DBU DCI FUP GUN HAG HSY MK SO SZ.

**14000-14400-KC.**

C.W.: WIAFB CKF DF EBT EH FTR GTV PL SZ TS.

PHONE: W1CKF SZ.

**28 MC.:** W1CKF.

**56 MC.:** W1EFW.

\*See page 19 for announcement.

## 73

Many of us have often wondered where the telegraphers' conventional signal of greeting, "73," had its origin. It dates back to the early days of telegraphy. During the Civil War, Andrew Carnegie administered both the telegraphs and the railroads. Shortly after the war the Order of Military Telegraphers was organized. The members of this order had a fine "esprit de corps."

During the Civil War, telegraphy was just as new as radio was during the World War and the operations of armies depended in a large measure upon the intelligent use of the telegraph. Upon Andrew Carnegie reaching the age of 73, the Order of Military Telegraphers gave him a testimonial dinner and from this the term "73" came into being as a symbol of good wishes.

—Office of Operations Bulletin, U. S. Navy

## A.R.R.L. Trunk Lines

Star coast-to-coast line of the A.R.R.L. Trunk Line System is the route W6ETL, Los Angeles, Calif.—W6BMC (ORS), Bard, Calif.—W9ESA, Denver, Colo.—W9KG (ORS-RM), Kansas City, Kansas—W1FIO (ORS), So. Norwalk, Conn. W6ETL maintains daily schedules with the Philippines, Hawaii and Guam. This line, operating daily, gives 36-hour (or better) service between those points and the east coast. Double daily schedules are maintained along the line so that traffic bound both east-west and west-east may be moved without delay. Each station maintains contact with other A.R.R.L. Trunk Lines so that traffic may be cleared to other states and so that DX traffic may be routed efficiently. Throughout the entire 1933-1934 winter season W6ETL, W6BMC, W9ESA, W9KG and W1FIO have been outstandingly reliable and conscientious in keeping the trunk running. Good work, OMs.

There are fourteen A.R.R.L. Trunk Lines in the complete system. These run both east-west and north-south, interlocking at numerous points so that a very comprehensive and effective network results. The present system has been in effect since 1931 and each year includes a majority of the most active and reliable traffic men. An up-to-date outline map showing all A.R.R.L. Trunk Lines will be ready for distribution on or about April 15th. A copy will be mailed to anyone requesting same.

## Coming Hamfests

A New Hampshire state Hamfest under the auspices of Basil Cutting, W1APK, N. H. SCM, will be held at the Hotel Carpenter, Manchester, N. H., Saturday, April 7th. Opening at 3:00 p.m., activities will include well known speakers, contests, prizes, broadcast over WFEA, local BC station, and plenty of "gab-festing." A big banquet at 6:00 p.m. will wind up the day. Registration is \$1.50; those signing up in advance should do so through Miss Dorothy Wilkins, W1FTJ, Radio Service Lab., 1008 Elm St., Manchester, N. H.

The Sheboygan (Wisconsin) Radio Amateurs Club announces its Second Annual QSO Party to be held April 14th. Anyone in the vicinity of Sheboygan on that date is invited to attend. Complete details from M. Kotte, W9JDP, Sec'y, 1002 Clara Ave., Sheboygan, Wis.

An Eastern Pennsylvania Hamfest under the auspices of the Allentown Amateur Radio League will be held at American Legion Hall, Allentown, Pa., on April 21st. Complete details from Raymond F. Hall, Sec'y, 1648 Hamilton Street, Allentown.

SCM Martin, W6AAN, reports that the Quarterly Banquet of the Federation of Radio Clubs, Southern California, will be held April 21st at Women's Club House, Friend & Bailey Streets, Whittier, California, under the auspices of the Whittier Radio Amateurs Association. The program, starting at Noon, includes technical talks, exhibition by manufacturers, raffle, speakers, entertainment for ladies, and will wind up with the big feed at 8:00 p.m. followed by distribution of prizes. Attendance at the last Southern California quarterly banquet was 560!! Don't miss this April affair!

The Wichita Falls Amateur Radio Club, Wichita Falls, Texas, will hold its Annual Banquet on April 21st at the Woman's Forum. All amateurs are invited.

The contribution by Mr. Duane Magill, W9DQD, wins the C.D. article contest prize for this month. Your articles on any and all phases of amateur communication activity are likewise solicited, and may win you a bound Handbook, or equivalent credit applied toward League emblems, log books or other A.R.R.L. supplies.—F. E. H.

## Judgment in Operating

I SUPPOSE that the average ham seeing a statement "on being too good an operator" would be likely to utter some such remark as, "Huh, it can't be done." That is probably true, in a very general sense at least, and far be it from me to deny it. But none of us can at any given moment be operators in a general way. Our time spent on the air consists of a series of individual QSOs—and in any given QSO it is very easily possible for either or both of the operators concerned to be "too good" for the occasion.

Let's take an example. Suppose I work a station which we will call W7XXXX. Now it seems that W7XXXX is possessed of a new bug key, of which he is very proud, with which he can send beautiful stuff at forty words per minute—and, moreover, he persists in doing so on all occasions. Now his sending may be beautiful, and all that, but I freely confess that I can't copy forty words per anywhere near it, so its beauty is all lost on me. W7XXXX is simply "too good" an operator for me.

Or another common case: W9ZZZZ answers my CQ, interspersing the call with "BK BK." All fine, but it happens that my oscillator makes a dickens of a racket whether I'm keying the transmitter or not, and, moreover, my filaments require enough time to get going that breakin is almost out of the question anyway. Nevertheless, I hate to waste his time and my own as well, so after some indecision I take a chance and break him, not knowing whether he got it or not. Likely as not I began calling him at precisely the wrong moment, and lots of confusion may result before the QSO gets off on the right foot. But the point is that W9ZZZZ is too good an operator for the occasion, and is expecting more of me in consequence than I can deliver.

The list could be extended *ad infinitum*, but enough has been said to make clear what I mean. The important thing to remember is to match your sending to your victim's receiving. If it should happen that you are working an old-timer who can copy forty per and knows all the abbreviations and Q signals—that's fine! Shoot the works and make him like it! But if he is a newcomer to the game, or if he belongs to the large class of which I am one—those of us who have been in the game long enough to become good operators, but aren't—then use discretion.

It is good practice to send to the other fellow at the same speed at which he sends to you. The use of good judgment in matching your skill to operators you work will go far toward ending the abomination of the "too good operator." You'll really be saving time for yourself by it.

—Duane Magill, W9DQD

## Traffic Briefs

W5BMI, one of our most ardent brasspounders, took an inventory on January 1st and found that during 1933 he averaged nearly 11 QSOs per day, and that during the past three years he averaged over 10 QSOs per day!! Not satisfied with those records he started 1934 with a bang by making 644 contacts during January (and he was out of town three full days)—that figures 23 QSOs per day! Perhaps we should call him radio's "QSOiest Ham." Any competitors?

### OPERATORS WANTED BY C.C.C.

Lt. H. O. Bixby, Signal Corps, Baltimore, Maryland, advises of the establishment of Civilian Conservation Corps radio nets in the states of Pennsylvania, Maryland and Virginia, which states comprise the Third Corps Area, U. S. Army. There are thirty stations in the Nets, consisting of a Corps Area Net Control Station at Baltimore, a Pennsylvania N.C.S. at Reading, and a Virginia-Maryland N.C.S. at Sperryville, Va. These stations operate as government stations for handling administrative traffic during the daytime on 4445 and 4305-kcs. At night they will operate as strictly amateur stations; amateur calls are now being secured.

There is a possibility there will be an expansion in the number of stations and in the number of operators assigned to each station. In view of this fact Lt. Bixby reports that licensed amateur operators from Pennsylvania, Maryland, D. C., and Virginia will be considered for enrollment in the C.C.C. during the next enrollment period starting April 1st for duty as operators at these stations. Applicants must qualify under C.C.C. regulations, and should be able to take fifteen words per minute or better and have at least two years' experience in amateur radio. Preference will be given to men who have held or now hold station and operators licenses.

The radio supervisor, Camp No. 250, Reading, Pa. will be pleased to correspond with any amateurs in that state who may be interested in enrolling. Likewise, the radio supervisor, Company No. 1393, Sperryville, Va. will correspond with amateurs in Maryland, District of Columbia and Virginia.

### 1.75 MC. TRANS-ATLANTIC WORK

Results of the "160 meter" trans-Atlantic tests (see p. 52, Feb. QST) reported to date are as follows: G5WU, Penarth, Glam., Wales and WIDBM, North Falmouth, Mass. were QSO on both February 3rd and 4th. G5WU was using P.P. TPTG with crystal (approx. 1780-kcs.) across grid coil, with ten watts input. These were the first contacts between G/W stations since the WIDBM-G6FO QSO of February, 1933. Other 1.75 mc. stations heard in Great Britain during February, '34 include WICBK, WICCX, WIATE, W2DYY and W8BFN, all on c.w. The stations logging the W amateurs were G5UM, G5FI, G6YJ and G5WU. Reports on future trans-ocean contacts and reception on "160 meters" should be forwarded to A.R.R.L. HQs.

WIDIK, E. Providence, R. I., "160 meter Phone" was heard at 1:15 a.m. EST, January 14th by HP1A, Republic of Panama. WIDIK was calling "CQ test Great Britain" at the time and although not heard across the pond he was putting in an R8 signal with QSA5 readability at HP1A.

Add to list of 1715-kc. Code Practice Stations: W9MQM, La Grange, Ill. sends code practice each Tuesday and Wednesday from 6:00 to 6:45 p.m. CST on 1975-kcs. The Houston Amateur Radio Club, W5DPA,



transmits code practice on 1.7 mc. phone Mondays 7:30-8:30 p.m., and Fridays 7:00-8:00 p.m. CST. W8ARF, W8DDX and W8FO, all of Toledo, Ohio, will conclude their code practice lessons within the next few weeks.

The Akron (Ohio) Progressive Short Wave Club sends code lessons in the 1.75 mc. band daily except Saturday and Sunday between 7:00 and 7:45 p.m. through the following stations: Mon. W8JTI, Tues. W8HWV, Wed. W8LBH, Thurs. W8GIL, Fri. W8KMN. McMasters, W4BCZ transmits code practice on 1930 kc. Mondays at 8 p.m. E.S.T. with W4CSJ and W4QY assisting in operations.

SCM Harris, VE4HM, reports that CIW4, station of the Royal Canadian Naval Reserve Corps, is in operation at Edmonton, Alberta, and would appreciate reports. Complete address is R.C.N.R. Corps, Prince of Wales Armories, Edmonton, Alta., Canada.

## January, 1934—O.R.S. QSO Party

THE January QSO-fest for O.R.S. appointees was one of the "best yet." Kentucky challenged all other A.R.R.L. Sections to contend for the best showing in the Highest Ten Scores, and the Fort Wayne Radio Club, W9LWK, offered a 3.5 mc. crystal to the O.R.S. with the highest score. These two factors made competition unusually keen and added much to the success of the affair.

On behalf of Hq. and the entire O.R.S. A.R.R.L. field organization we extend hearty congratulations to Kentucky upon making good her challenge. Seven of the Highest Ten are Kentucky stations!! Kentucky O.R.S. were out "en force," displaying a spirit of teamwork and friendly individual competition between operators of which any Section can well be proud. Kentucky has established a high mark for other Sections to shoot at both in accomplishment and Section cooperation. W9AUH won the W9LWK-crystal-prize, contacting 131 stations in 42 A.R.R.L. Sections and logging 73 additional O.R.S. The Ten Highest Scorers follow:

W9AUH, 25,116	W3ZD, 15,400
W9BWJ, 19,305	W9CNE, 15,096
W9JYO, 19,070	W9OX, 13,926
W9KKG, 17,920	W9EMN, 13,392
W9ETT, 16,575	W9ICN, 11,850

"During the contest I contacted Maine twice. Have been on the air for four years but never worked Maine before."—W9HTZ. "I get a bigger kick out of the ORS Party than anything else in ham radio."—W9KGR. "If such fine operating procedure could be always found in our bands as was noticed in the ORS Party we would be truly living in an amateur Utopia."—W9HSK. "Had a good time and it showed how the boys would function in a real emergency. The best way to keep the operators and equipment in shape."—W3ZD. "W9ETT worked K6VG and was called on the same CQ by VP5PZ, some DX!"—W9OFE. "Didn't intend to enter but when W1MK pulled my little old '10 out of the QRM on 80 meters, I decided I might as well have some fun. Hi."—W9EPT. "Party FB here. Ky 'went to town' in a big way. Wish the boys in this Section could get together that way."—W4BBT. "Push-pull xtal with 2- 233 tubes and 250 v. battery, 18 Sections, 34 QSOs, 117 heard, 4,734 score."—W8AQE. "These contests give stations a chance to QSO where you would never be answered otherwise."—W9CDE. W1MK (ev) made a score of 17,908, but since an objection was received on listing this station among "the Ten," the score is given only for the information of O.R.S. and other A.R.R.L. members who may be interested in the work of their Headquarters station.

Leading scores in each A.R.R.L. Division follow: Atlantic W3ZD 15,400; Central W9AUH 25,116; Dakota W9GNU 1680; Delta W5BMI 5500; Hudson W2EKM 10,947; Midwest W9DFE 8680; New Eng. W1COI 6090; Northwestern W7CRH 396; Pacific W6BHV 3914; Roanoke W3DVO 4692; Rocky Mt. W9CDE 1360; South-

eastern W4APU 8038 West Gulf W5ARV 10,392; Ontario VE3GT 9585; Quebec VE2CX 4664; Brit. Col. VE5AC 651.

## O.R.S. QSO PARTY ANNOUNCEMENT

The second 1934 quarterly QSO Party/Contest for O.R.S. will be held April 21st and 22nd. Complete details will reach all O.R.S. appointees via their regular bulletin. Non-O.R.S. are invited to make application for appointment to the proper S.C.M. (See address page 5 this QST.) Only O.R.S. may participate in the quarterly QSO parties—and they're too much fun to miss.

## Roster, A.R.R.L. Official Phone Stations

SINCE our first O.P.S. tests the number of Official Phone Stations in the A.R.R.L. field organization has practically doubled, and will probably have passed the hundred mark by the time this appears in print. 91 appointments have been made in 41 of the 69 A.R.R.L. Sections.

The station signal and operating standard have met the test in every case. O.P.S. operators are pledged to use circuit precautions avoiding overmodulation, and to live up to the Amateur's Code of fraternalism and co-operation. A.R.R.L. Section Managers will welcome applications, and send necessary O.P.S. forms to any 'phone amateur who is a League member.

Every O.P.S. is invited to work every other O.P.S. in the April Party. Which station will work most of those 41 Sections? The roster follows:

W1APK, W1ASY, W1ASZ, W1AUY, W1AZV, W1CCM, W1CNA, W1DQK, W1DUZ, W1EAW, W1FEX, W1GEY, W1SZ, W2QY, W3AEI, W3AHC, W3AHQ, W3ASK, W3BGP, W3BIG, W3BWP, W3CJ, W3CNY, W3CQO, W3GY, W3ZA, W3ZX, W4AAD, W4BMM, W4BPC, W4KB, W4PW, W4RV, W4WS, W5AXU, W5BAY, W5BPL, W5ON, W5SP, W5ZM, W6AGQ, W6AOF, W6BCR, W6BHF, W6CBF, W6CGU, W6DKF-GDI, W6GNP, W6IBK, W6IT, W6LD, W6QE, W6TF, W7AHZ, W7BDC, W7BUF, W7AAR, W8ABS, W8AFM, W8AHF, W8AYA, W8CFE, W8CJG, W8CMY, W8DIV, W8DZF, W8ESN, W8FMM, W8FSY, W8FTB, W8FUO, W8GDC, W8GJM, W8HC, W8IGA, W8IKZ, W8NW, W8VJ, W8AXH, W9BBL, W9BGE, W9DFZ, W9DKL, W9EMU, W9FYP, W9HCO, W9LXN, W9JHY, W9TE, W9YB, K6CIB, VE2BG, VE4GA.

## OFFICIAL 'PHONE STATION PARTY

Virginia seems to have the leading A.R.R.L.—O.P.S. Section organization to date, with regular radio O.P.S. get-togethers every week, so it is no accident that Virginia stations are prominent in the Jan. 20/21 activity reports. Scores reported are as follows:

W3CNY 96	W1APK 18
W3GY 78	W1SZ 18
W3BIG 60	VE4CA 4
W3CJ 42	

K6CIB, W7BDC, W5BHO, W3AHQ, W1AUY, W8ABS, W4WS, W3ZA and W3ASK are also known to have been active, since they were reported heard or worked by the above stations. The consensus among those reporting was that the quarterly QSO Parties were enjoyable and worthwhile, and would increase in interest with the number of O.P.S.

Over 25 new Official 'Phone Station appointments have recently been made. Additional applications are under consideration by S.C.M.s. Copies of the 8-page January O.P.S. Bulletin, and the new April bulletin (when issued) will be sent to appointees entered on Headquarters' records during April.

## APRIL 21-22 O.P.S. QSO CONTEST

Full details of the second 'phone QSO Party (only O.P.S. eligible to take part) will be mailed all appointees before the dates of this activity. Mark your calendar if you are an O.P.S. and be on deck for some "swell" operating fun. Watch the scores mount too. More A.R.R.L. Sections will be represented in the April Party!

Bernard B. Hansen, W9KNZ/JNV, Woodmen, Colorado, uses his log book for an "amateur radio Diary, Scrap Book and Log combined," making it a valuable personal reference and station history. The left hand pages of W9KNZ' log are used to record such things as date license received; club memos; interesting data on ham discussions; visitors at shack; circuit diagrams and details; changes in rig; dope on s.f. transmissions; DX notes; dope on portable operation; date of antenna changes; record of new schedules; transmitter settings for different bands; autographs; message traffic count each month; QSL record (ruled columns). Club membership certificates, photos, banquet tickets and convention programs, news clippings, convention photos, and the like are all pasted in the log for safe keeping. W9KNZ will surely have something to look back on in years to come. Try this method of making full use of your log, hams.

Attention is called to the fact that CQ's should always conclude with a "K," not "AR." The General Radio Regulations annexed to the International Telecommunication Convention specify that the inquiry signal "CQ" shall be followed by the letter "K," and this regulation has been in effect even as far back as the Washington Convention. Therefore, the proper procedure is "CQ de W6CUU K" rather than "CQ de W6CUU AR." This does not, of course, militate against the use of AR at the end of messages and calls to other stations.

Ed Marriner, W6BLZ, Laguna Beach, California, sends some interesting notes on his trip in November, 1933, to Australia and New Zealand. He sailed on a Norwegian oil tanker as deck boy. At Brisbane, VK4RJ showed him the town. At Dunedin, visiting ZL4BA it was learned that the ZL4 Otago Convention was under way so W6BLZ hopped a cable car and joined the fellows at the festivities. He was presented with the honorary NZART beer spigot and a subscription to "Break In." At Auckland, visits to ZL1AB, ZL1CE and ZL1GT proved of great interest. Most of the hams there use '10s in P.P. due to the cost of parts. A \$1.00 fifty-watt socket sells for \$5.00, and '66s bring \$16.00. QST's run around \$.65 per copy! W6BLZ extends his thanks to the VK and ZL gang for showing him a "swell" time.

KA1NA, Alongapo, P. I., announces the conclusion on April 8th of his Sunday 7 mc. tests. He would like reports from all amateurs who have followed the tests throughout the winter. Among eastern amateurs heard at KA1NA are W1ZI, W1SI, W4FT and W8BL.

A big snow storm in February hit Long Island, N. Y. very hard. W2BRB, Bellmore, was isolated for two days—no trains, busses or telephones. He used amateur radio to notify his boss, sending a message via W2BPM.

Likewise, John Cook (call unknown) of Baldwin, L. I., notified his boss of his predicament via W2CSE. Amateur radio to the rescue again! Hi.

W4PL, Shepherd, Tenn., says you can say all you want about message QSP, but did you ever hear of QSPing a ham himself? W8EDO, Carleton, Michigan, was offered a job in Florida, if he could get there. So he started out to hitch-hike it. He put up a day or so at W4PL. When it was time to move on they called up W4RO, Morristown, Tenn. RO knew a fellow who ran a line of trucks to Florida. Arrangements were made by radio and that night a nice, comfortable (?) truck stopped in Shepherd and took W8EDO on board, carrying him all the way into Florida.

W2DT, Brooklyn, N. Y., suggests an amateur "chain-phone system" whereby the signals from one station will be picked up and retransmitted from station to station, and from band to band, so that a given message or announcement at the originating station, or key station, would be received simultaneously at every station in the network. W2DT writes: "W2GF and I have worked together, he on 1963-kes. and I on 1806-kes., with sufficient volume in the duplex transmissions so that other amateurs could plainly hear both stations while listening to only one of us. And this has been done without feedback troubles, and only by pickup of the receiver's loud speaker by the microphone." Amateurs desiring to join such a network communicate by mail with W2DT, Nathan F. Schilling, 44 Court St., Brooklyn, N. Y.

#### ABOUT BUGS

W8FYA suggests that the first models must have been made without weights, and gave forth a buzzing sound, instead of "Morse" dots, hence the name "BUG" key. He remarks, "Even my own bug which local hams think 'too slow' has the dot contact set for ten dots per second. Adding a small additional weight brought it to six dots per second—and I can still send plenty fast." All operators using a bug should read W. E. MacClaren's article in Feb. '33 QST (page 76) on "Sending Speed" and the dope on "Bugs" on page 19 of Feb. '34 QST.

#### ELECTION NOTICES

To all A.R.R.L. Members residing in the Sections listed below: (The list gives the Sections, closing date for receipt of nominating petitions for Section Manager, the name of the present incumbent and the date of expiration of his term of office.) This notice supersedes previous notices. In cases where no valid nominating petitions have been received from A.R.R.L. members residing in the different Sections in response to our previous notices, the closing dates for receipt of nominating petitions are set ahead to the dates given herewith. In the absence of nominating petitions from Members of a Section, the present incumbent continues to hold his official

### Relative Standings of the Ten Highest Sections—January—February

Messages Per Station (25%)	Stations Reporting Traffic (25%)	Gain or Loss (Traffic Reports) (25%)	Traffic Total (25%)	Standing Based on Average of All Four Ratings %	Section Communications Manager
Colo. 427.	Los Ang. 139	Los Ang. +11	Los Ang. 7847	Los Angeles 75.	Martin, W6AAN
M.-D.-D.C. 394.1	Mich. 95	San Fran. +10	E. Pa. 6709	E. Penna. 45.	Wagenseller, W7GS
Tenn. 330.9	Va. 82	Manitoba +7	Ill. 6362	M.-D.-D.C. 40.	Hudson, W3BAK
S. Tex. 308.5	Ill. 74	E. Pa. +6	M.-D.-D.C. 5912	Illinois 37.5	Hinds, W9WR-APY
Nebr. 240.3	N. C. 62	Ky. +6	Kansas 5311	Michigan 35.	Conroy, W8DYH
E. Fla. 235.4	N. Y. C.-L. I. 57	Ont. +4	Mich. 4821	Colorado 25.	Becker, W9BTO
Okla. 227.8	Wash. 55	Sac. Val. +4	N. N. J. 4382	Tennessee 22.5	Purdy, W4AFM
P. I. 204.1	Oregon 49	W. Fla. +3	Ohio 4065	San Francisco 22.5	Goodman, W6CAL
S. Die. 184.4	E. Pa. 47	N. Dak. +3	E. Fla. 4002	Virginia 20.	Eubank, W3AAJ
N. N. J. 182.5	Ohio 46	W. Va. +2	Tenn. 3971	Manitoba 20.	Strong, VE4GC



LOS ANGELES is again the Banner Section with an all-round rating considerably higher than any other Section. L. A. is also the only Section having over 100 traffic reporters. During the January 16th-February 15th month, 1638 stations Originated 29,199; Delivered 28,019; Relayed 73,008; Total 131,126. (96.1% Delivery) (80 messages per station). The following Sections lead all other Sections in their Divisions. *order of listing showing relative standing of their different Divisions:* L. A., E. Pa., N. N. J., E. Fla.-Ala.-Ga.-etc. tied, Mich., Tenn., Kans., E. Mass., S. Tex., Va., Colo.-Utah-Wyo. tied, Wash., S. Minn., Ont.

position and carry on the work of the Section subject, of course, to the filing of proper nominating petitions and the holding of an election by ballot or as may be necessary. Petitions must be in Hartford on or before noon of the dates specified.

Due to resignations in the Santa Clara Valley, Utah-Wyoming, South Dakota, and Southern Minnesota Sections nominating petitions are hereby solicited for the office of Section Communications Manager in these sections and the closing date for receipt of nominations at A. R. R. L. Headquarters is herewith specified as noon, April 16, 1934.

Section	Closing Date	Present SCM	Present Term of Office Ends
Alabama	Mar. 15, 1934	L. D. Elwell	Mar. 15, 1934
Santa Clara Valley	Apr. 16, 1934	Bruce Stone (resigned)	.....
Utah-Wyo.	Apr. 16, 1934	Cutler B. Miller (resigned)	.....
S. Dak.	Apr. 16, 1934	Carroll B. Miller (resigned)	.....
Southern Minn.	Apr. 16, 1934	Norman Beck (resigned)	.....
Mississippi	Apr. 16, 1934	Win. G. Bodker	Jan. 15, 1933
Virginia	Apr. 16, 1934	R. N. Eubank	Dec. 15, 1933
Eastern Florida	Apr. 16, 1934	Ray L. Atkinson	Dec. 15, 1933
Alaska	Apr. 16, 1934	Richard J. Fox	Feb. 15, 1934
N. Dak.	May 1, 1934	Wm. Langer	May 10, 1934
Saskatchewan*	May 1, 1934	Wilfred Skafte	June 15, 1934
Quebec*	May 1, 1934	John C. Stadler (resigned)	.....
Nebraska	June 14, 1934	S. C. Wallace	July 1, 1934
Missouri	June 14, 1934	C. R. Cannady	July 1, 1934
Wisconsin	June 14, 1934	Harold H. Kurth	July 1, 1934
Western Mass.	June 14, 1934	Earl G. Hewinson	July 1, 1934
Illinois	June 14, 1934	Fred J. Hinds	July 1, 1934
Western Penn.	June 14, 1934	C. H. Grossarth	July 1, 1934
Indiana	June 14, 1934	Arthur L. Braun	July 19, 1934
Northern N. J.	June 14, 1934	Walter A. Cobb	July 19, 1934
Kansas	July 16, 1934	O. J. Spetter	July 23, 1934
Ohio	July 16, 1934	Harry A. Tummonds	Aug. 1, 1934
Southern Texas	July 16, 1934	David H. Calk	Aug. 8, 1934
Nevada	July 16, 1934	Keston L. Ramsey	Aug. 15, 1934
Oregon	July 16, 1934	Raymond L. Cummins	Aug. 15, 1934
Kentucky	Aug. 15, 1934	Carl L. Pflumm	Sept. 8, 1934

\* In Canadian Sections nominating petitions for Section Managers must be addressed to Canadian General Manager, Alex. Reid, 169 Logan Ave., St. Lambert, Quebec. To be valid such petitions must be filed with him on or before the closing dates named.

1. You are hereby notified that an election for an A. R. R. L. Section Communications Manager for the next two-year term of office is about to be held in these Sections in accordance with the provisions of By-Laws 5, 6, 7, and 8.

2. The elections will take place in the different Sections immediately after the closing date for receipt of nominating petitions as given opposite the different Sections. The ballots mailed from Headquarters will list the names of all eligible candidates nominated for the position by A. R. R. L. members residing in the Sections concerned. Ballots will be mailed to members at the closing dates specified above, for receipt of nominating petitions.

3. Nominating petitions from the Sections named are hereby solicited. Five or more A. R. R. L. members residing in any Section have the privilege of nominating any member of the League as candidate for Section Manager. The following form for nomination is suggested: (Place and date)

Communications Manager, A. R. R. L.  
38 La Salle Road, West Hartford, Conn.

We, the undersigned members of the A. R. R. L. residing in the ..... Section of the ..... Division hereby nominate ..... as candidate for Section Communications Manager for this Section for the next two-year term of office.

(Five or more signatures of A. R. R. L. members are required.)  
The candidates and five or more signers must be League members in good standing or the petition will be thrown out as invalid. The complete name, address, and station call of the candidate should be included. All such petitions must be filed at the headquarters office of the League in West Hartford, Conn., by noon of the closing date given for receipt of nominating petitions. There is no limit to the number of petitions that may be filed, but no member shall sign more than one such petition.

4. Members are urged to take initiative immediately, filing petitions for the officials for each Section listed above. This is your opportunity to put the man of your choice in office to carry on the work of the organization in your Section.

**ELECTION RESULTS**

Valid petitions nominating a single candidate as Section Manager were filed in a number of Sections on or before the closing dates that had been announced for receipt of such petitions. As provided by our Constitution and By-laws, when but one candidate is named in one or more valid nominating petitions this candidate shall be declared elected. Accordingly election certificates have been mailed to the following officials, the term of office starting on the date given.

Oklahoma	Carter L. Simpson, W5CEZ	Feb. 15, 1934
Rhode Island	Albert J. King, W1QR	Feb. 15, 1934
Alberta	J. Smalley, Jr., V44GD	Feb. 15, 1934
East Bay	P. W. Dann, WZXX	Feb. 18, 1934
Montana	O. W. Viers, W7AAT	Feb. 18, 1934

**BRASS POUNDERS' LEAGUE**

(January 16th—February 15th)

Call	Orig.	Del.	Total
W6GX	133	247	1480
W4PL	12	64	1490
W6ZG	779	262	1433
W2D1U	234	162	1076
W8KJY	188	304	1064
W8EG	102	319	846
W2BCX	182	220	825
W5BMI	259	278	642
W4AFM	71	50	1022
W6ETL	106	209	816
W9E8A	21	65	974
W9MDL	76	769	175
W9LFE	80	152	782
W6BMC	49	71	880
W8FTW	125	90	766
W8GUF	98	102	768
W2EKM	186	125	644
W5CZ	15	15	871
W4BOU	73	113	648
W6GQC	66	65	696
W6E3W	66	151	604
W4RO	22	23	756
W3AZF	75	30	672
W9LQ	149	28	762
W9ABE	113	218	424
W8GZ	65	94	592
W7CZY	35	90	563
W1VS	29	124	524
W8CVS	70	81	514
W3OR	60	56	670
W3CL	51	235	373
W3BWT	86	102	434
W8G8U	135	108	375
W6LDQ	34	44	534
W6ALU	104	242	593
W8RN	120	68	401
W9BKX	93	71	424
W3AAV	316	228	25
W1AMG	118	113	332
W9BKK	58	72	424
W9L7	67	107	372
W9KFA	28	16	500
W91QI	137	87	302
W8SN	196	73	254
W9OFF	72	16	432
W5MX	126	140	518
W9LVJ	15	78	431
W3AKB	53	101	358
W91OL	108	82	319
W8DRX	24	45	438
W4AGI	208	206	92
W2D1U*	752	473	1876
W9HCX*	180	100	1358
W2EKM*	226	114	618

**MORE-THAN-ONE-OPERATOR STATIONS**

W3CXL	534	841	2330
W4CI	2525	12	6
NY1AB	146	177	1670
W6OW	269	175	1236
K4AIR	258	208	1680
A2ERT	345	212	361
W8YA	69	58	500
W9BNT	231	284	106
W6FWJ	324	40	160

\* Listing for these stations for December-January.

These stations "make" the B.P.L. with totals of 500 or over. Many "rate" extra credit for one hundred or more deliveries. The following one-operator stations make the BPL for *delivering 100 or more messages*: the number of deliveries is as follows: Deliveries count

W6GHD, 464	W3AQN, 127	KALLG, 104
W8BRZ, 235	W6JAL, 124	W6HEU, 103
W9NP, 232	W1CRA, 123	W9EFE, 102
W2CHK, 171	W1FTO, 121	W9H8V, 102
W6PFP, 170	W9OC, 114	W8AES, 102
W4BAB, 161	W8C10, 114	W9GNK, 102
W9BWJ, 154	W9FLG, 113	W7AYV, 101
W6AZU, 151	W7AVP, 111	W5ZM, 100
W8CCK, 146	W6GNM, 108	W8C11, 100
W2ELK, 142	W9LZP, 107	W9DNY, 100
V8EBC, 141	W3ALX, 107	W4CMI, 100
W6NK, 138	W8DZ, 107	More-than-one-opr.
W6ETJ, 130	W9DJU, 104	W1MK, 144

A total of 500 or more, or just 100 or more deliveries will put you in line for a place in the B.P.L. Make more schedules with reliable stations. Take steps to handle the traffic that will qualify you for B.P.L. membership also.

**O. B. S.**

The following is a supplement to the list of A. R. R. L. Official Broadcasting Stations in September QST (page 44): W1SH, W2DTT, W4CE, W5BFA, W5BUX, W6AZK, W8IGA, W8E5A.

## ATLANTIC DIVISION

**EASTERN PENNSYLVANIA—SCM,** Jack Wagenseller, W3GS—RMs W3MC and W3ALX. Eight stations make BPL: W3AZF, W3CVS, W3OK, W3CL, W3AAV, W3AQN, W3AKB and W3ALX. Following reported by radiogram: W3VR, CPJ, EDA and OK. W3DWZ has new Feb. QST antenna. W3AGK is on 14 and 1.7 mc. W3CVS can offer speedy QSP anywhere. YL QRM had at W3ABZ and W8FLA. RM W3MC has tube trouble. W3ADM visited WCAU. W8VD is finishing new rig. W3SB, ABE and CL report in person. ED at W3AMR is engaged. W3AAD reports the Quakertown Radio Club has dissolved. W3BLG is hearing lots of 14-mc. DX. W3ADE had lots of fun in ORS Contest. W8LCU and JKZ report for first time. W3DXQ finally conquered BCL QRM. W8IWT is new ORS. W8INA is joining Army Net. W9EWW is back at W8CPT for one more year. W3DZ and AJX reported by telephone. W3AQN has a nice bunch of schedules. W8ASW is taking Class A exam. W3BYS is lined up for ORS. RM W3ALX schedules W6 and W7 on 3.5 mc. daily. W3AZF reports for York Road Club and W3QV and EHZ. W3GS and ECD have been QRL 56 mc. Allentown Radio Club is planning hamfest for middle of April. A Radio Amateurs' Dinner Dance was held March 24th by the Western Radio Society. A very unusual affair, with over 300 attending. A new club, the Germantown "Y" Radio Club, succeeds the Quaker Club. The Norris-town gang are very active on 56 mc. W3AZT forwarded over 4000 QSL cards with no street addresses for amateurs in Philadelphia.

Traffic: W3AZF 777 OK 670 CL 659 AAV 569 AKB 512 AQN 321 MC 216 ADM 203 EZ 189 ALX 184 VR 177 EDA 145 SB 123 DXQ 116 QV 93 BYS 84 ADE 80 DZ 75 ABE 69 DGM 52 EHZ 50 GS 38 CPJ 34 ANZ 27 AMR 28 DRO-BLG 18 DWZ 14 ECD 10 DIJ 9 AAD 7 AJX 6 AGK 5 ABZ 3. W8CVS 675 IWT 111 FLA 105 CFI 69 VD 21 DIG 17 ILA 9 ASW 7 LCU 5 JKZ 4. W3CB 60 W8EOH 15 W8CFF 38.

**MARYLAND-DELAWARE-DISTRICT OF CO-LUMBIA—SCM,** E. I. Hudson, W3BAK—RMs W3CXL, W3CQS, W3CJS. Chief RM W3BWT. The Wilmington (Del.) Hamfest, held on Feb. 24th at the duPont Hotel, was a decided success. More than 300 attended despite the bad condition of highways. Loring Daniels, W3AJH, recently took unto himself a wife. W3BKC slipped on the front steps and broke a 21IE. W3HI burned out two dropping resistors, two electrostatic condensers and an '80, all in one night. Following make BPL: W3CXL, BWT, SN, BND, CQS. Report but no traffic: W3WN, EAX, DRE, ARM. W3CDQ (YL) made a visit to Cuba, and while there kept schedules with W3EX from CM2AN. Rebuilding: W3CWE, BWT. W3EHW, since coming on the air Dec. 25th, has worked all U. S. districts and several foreign stations. W3DML reports seven hams in one Washington High School. W3CIZ handled plenty Florida State Fair traffic. W3DXG is new ham in Camp Meade. W3ECP reports the Mike and Key Club, Baltimore, had a very successful hamfest on Feb. 3rd. The club meets on alternate Tuesdays, starting Feb. 13th, in Conference Room, Post Office Bldg., Balto.

Traffic: W3CXL 3605 BWT 621 SN 523 BND 292 CQS 278 CIZ 226 ASO 157 BAK 85 CDG 60 CTD 42 DML 7 WU 6 EHW 5 LL 3 CWE 2.

**SOUTHERN NEW JERSEY—SCM,** Gedney M. Rigor, W3QL—Apologies to W3AEJ re report of last month. ALL ORS, TAKE NOTICE: Any changes, renewals or reinstatements needed, please mail your last ticket to the SCM for endorsement immediately. W3UT is handling traffic again. W3DRP is coming on with high power. W3CWL has 24 schedules per week. W3BEI has gone 'phone. W3ZI handles the Army Net and wants some A.A.R.S. in the Trenton section. Princeton Radio Club is active. W3AZZ has new bug. W3APV headed a delegation to the So. Jersey Radio Ass'n meeting to hear an inspiring talk by Major Edwin Armstrong, who came from N. Y. C. to talk to the club, his first appearance in public since 1922. The Atlantic Radio Club invites

your presence at Hamfest, April 14th, Hotel Jefferson, Atlantic City, N. J. Price one kilowatt and half. To W3DSC: Short circuit plate and grid, rest will be easy. W3DPE reports YLitis. W3CQO's mother passed away. W3ZX won first prize, silver loving cup, for best station in S. J., given each year by the S.J.R.A. W3BEI was second and W3BUB third. W3ASG was badly cut up in automobile crash.

Traffic: W3AEJ 42 DSC 48 APV 93 AZZ 13 DH 61 ZI 25 BEI 30 CWL 113 UT 14 KA 15 AVJ 6 QL 1 BYR 8 KW 7.

**WESTERN NEW YORK—SCM,** Don Farrell, W8DSP —RM W8DSS is back on the air. W8DHU worked Japan on 14 mc. W8GWY is in special net cooperating with power company. W8BJO had many visitors. The hams of Rochester beat Buffalo in a bowling contest, five games to one. W8FTB is a member of "ITK." W8AFM is interested in checking distortion and off-frequency operation. W8GWZ had a fine QSO with W2CIF on 14-mc. 'phone. W8DBX is the banner traffic station. W8AQE scored 4734 points in ORS Party. W8FDY reports Utica "A.A.R.S." Net working FB. W8AGS is on 'phone. W8EBR is busy with school. W8KKR moved to Eastwood. W8EWP is building velocity mike. W2BIN is now W8LLS at Cornell University. W8EAC is back after two-year lay-off. W8AYD schedules Panama so a mother can keep in daily contact with her son. W8DZF has been busy getting rid of telephone and BCL QRM. W8NW was heard by NZ16W in New Zealand on 1975 kc. W8FSY is doing fine work on 1.7-mc. 'phone. W8EMW joined Naval Reserve. Reporting traffic: W8IDJ-BR-GPT-JJJ-FYF-BWY-CJJ-BQJ-FMX-BOL. New calls: W8LGY-LGV. Rebuilding: W8KJO-ERU-GZM-GWT-BGN-DMJ. Reporting: W8ECF-EAK-EAJ-AOY-KZP-JSW-EYC and LLZ all on 1.7-mc. 'phone. W8IMR and KMC report. W8JAK has a new Class "A" ticket. W8JTT wants ORS. W8LIJ, IYL are new reporters. The Mohawk Valley Brass Pounders are going strong. W8DST is now president of the club. Active members are: W8LGE, LGO, LGZ, HQX, HNZ, KOD, HNY and JUI. W8AU is Chief Op at WPGJ in Utica. W8AXE is saving for high power. W8ETH is building tritet. W8DHB was badly hurt while cranking his truck. W8EDA is busy at Post Office. W8LFK of Ogdensburg was formerly 8UF, one of the ops at Clarkson Tech. W8KJW is looking for ORS-OBS. W8BFF has been appointed O.O. W8ERY and AYD are new ORS. W8GWW is on from W8AYD. W8KIR is an ole timer.

Traffic: W8BJO 283 CJJ 79 DSS 48 FYF 98 DBX 507 FDY 126 EAC 109 AYD 93 FSY 126 EYM 169 JAK 58 KJW 73 ERZ 488 GZM 18 DHU 80 GWY 30 FMX 10 HQJ 18 FTB 16 GPT 23 IDJ-EBR 35 EWP 10 JTT 19 KMC 14 DMJ 3 GWZ-BWY 6 AQE 7 JJJ 8 BR 9 AGS 8 LLS 6 DZF 2 NW-BOL 8.

**WESTERN PENNSYLVANIA—SCM,** C. H. Grossarth, W8CUG—W8GUF's fourteen schedules per day runs up a leading total! W8BWL reports lots of Altoona activity. W8YA needs a schedule with Pittsburgh badly. W8FZG visited in Pittsburgh with DKB. W8CQA is trying new antenna coupling system. W8CMP is busy with "Five and Ten" transmitters. W8AXD says KDM is on with pair of tens. W8IQB is DXing on 14 mc. W8ABS was appointed Phone Route Manager. W8ESR finally landed a job. W8GJM says COL is on 1.7-mc. 'phone and KEW worked all districts on 1.7-mc. 'phone. W8AYA, a new OPS, helped the R.I. locate a bootleg broadcaster. W8GBC and FKU are rebuilding. W8KQO has been getting ready for DX Contest. W8KRG says HMJ is QRL aviation ground school. W8KSG has been testing on 28-mc. 'phone. W8ITV reports KRY worked a ZL on 7 mc. W8CPE relieved the SCM of a bunch of Edison batteries. W8IFA's trouble is BCL QRM. W8IXQ is trying Class A. The Valley Amateur Radio League of Donora sends code practice on Mon. and Thurs. at 7:30 p.m. on 1.75 mc. through W8IXQ and KJM.

Traffic: W8GUF 968 YA 627 BWL 183 KWA 146 HGG 104 CUG 63 FZG 48 CQA 36 CMP 15 AXD 13 IQB 12 ABS 10 ESR 9 EEC 7 GJM 4 AYA 3 GBC 2 CRA 4 KQK-KRG-FKU 1 CPE 64.

**CENTRAL DIVISION**

ILLINOIS—SCM, F. J. Hinds, W9WR-W9APY—RMs W9CRT, W9DDE, W9VS. Would you boys like to have a traffic total contest in Illinois? If so, express your desires in your next report. "Podunk News" and "Radiator," ham sheets, were received this month—excellent papers both. W9DRV has a ball and chain. W9DKU has gone in for 'phone. W9FWD spent sixty cents to deliver an important message by telephone. W9PYJ is new traffic man. W9DXX worked Byrd Expedition. W9AIO has new rig. W9HQH handled a cumulative birthday message to President Roosevelt. W9HYI is digging trenches, at BCL station WIND, for installation of a reflector to shoot signals into Chicago area. Egyptian Radio Club plans hamfest for middle of April. Write W9FYZ about it. W9KJY installed a buffer stage. W9LVQ would like to hear from any "Hi-Y" member. W9ERU says Rockford is 25% for QSO and 75% for rebuilding. W9ENH is trying 'phone. W9EQZ says traffic is on upgrade. W9CRT delivered a Byrd Expedition message. W9SG is building new power pack. W9JO handled a lot of Miami, Fla. State Fair traffic. W9LGT has new junior op. W9ICN has a 59 osc. W9ILW was given a '52 for her birthday by ICN. W9IYA handled most of his traffic in ZAG contest. W9IBC has new FBXA. W9OJJ wants to join A.A.R.S. W9PEX has a '45 rig. W9IZP is giving 14 mc. a trial. W9DBO is NCS of sub-net C 2nd district Illinois. W9LNI is recovering from operation. W9MDL sends eleven traffic reports. W9DJG says there is a new set of masts at Egyptian Radio Club. W9CZL is going 'phone on 3.9 mc. W9CUH installed 'phone. W9MBQ is going to 1.7 mc. 'phone. W9MED is working on tritet. W9NN has P.P. '52s and '04 on 7 and 14 mc. W9NIU uses Hartley. W9GYP is working hard at U.S.N.R. W9HUX is joining A.A.R.S. W9EMN plans a radio club for Taylorville. W9FGV leaves Illinois to become an 8. W9FXE is trying 14 mc. tone. W9FO worked K5AJ, France Field, C. Z. W9MNV worked Hawaii on 7 mc. W9AFN is building 1 KW rig. W9LW has 800 watts input. DX hounds: W9PNE, MJE, KJX. On 1.7 mc. 'phone: W9AOV, NNE. Rebuilding: W9KEH, KWP, OQJ, BRX, KOQ. Changed QTH: W9GLW, EVJ, GRW.

Traffic: W9KJY 1456 MDL 1020 ILH 546 EVJ 514 DOU 438 LZU 345 FGV 197 CGV 187 MIM 184 EQZ 150 IYA 130 CRT 89 ORT 70 KJX 61 LW 59 JO 58 OMA 57 KHB 52 MLH 45 GYP 43 FXE 39 CZL 37 OSQ 35 AD-IBP 34 DJG 33 GRW-HPG-ICN 28 IBG 26 FO-SG 23 FCW 19 DBO 18 OJJ-HQH 17 HUU 15 FYZ 13 IZP-KEH 12 AFN-HUX 11 ISM-MBQ 10 CUH-LNI-MDH 9 AVB 8 CKC-EMN-GLW 7 BYZ-JNB-NN 6 FWD-GDE-MNB 5 JZF-MHD 4 CEO-ENI-KWP-MJE 3 CM-FTX-LSM-MFL-MKD-OVW-PHX-WR 2 LIV-NIU-PBQ 1.

INDIANA—SCM, Arthur L. Braun, W9TE—W9DJJ likes Class B 'phone. W9DJU takes state traffic honors. W9DET says the Wabash Valley Radio Club welcomes all hams near Terre Haute to meetings. W9EOC and HML are both now happily married. Congrats. W9EPT joined A.A.R.S. W9GFS had FB time in ORS QSO party. Want schedules: W9EGQ, HUV, CUZ. QRL: W9HSF, FQ, HPQ, DGC, KDD, LLV, DNQ, JOQ, JJA. Active: W9DPL, LG, BCP, OXG, NEE, JJI, IBX, AIN, BTR, LLE, MFU. W9HTP is waiting for RI to return his license. W9HUF wants ORS. W9LSB says c.c. beats self excited. Ex W9BXC signs W9LW in Franklin. W9MIG has a pair of '66s for rectifiers. W9OXM is trying to teach his 5 year old son the code. W9PEF and PEG are brothers. W9PDS is new at South Bend. W9YB ops both 'phone and c.w. W9MSZ will be on from new QRA soon. From Purdue we hear they are planning the hamfest up there for April 14 and 15. Don't miss this hamfest. Last year over 300 attended. A new club was organized at Indianapolis, the Indianapolis Radio Operators Club. Officers: W9ELX pres., W9LQ vice-pres., W9MQQ secy.-treas., W9TE chief op., W9CTV director, W9EEJ director. Those interested write W9MQQ, 2277 Churchman Ave., Beech Grove. W9NOZ puts out code practice for local fellows. On 1.7 mc. 'phone: W9DWY, BKH, CKB, PSV

(ex9ELE). New ORS: W9HBK, HUO, JRK. W9NEE is putting up new 50 ft. towers. W9JRR has new ant. coupling system. W9PIR entertains at a local beer palace in an orchestra. Rebuilders: W9LSZ, DWL, AKJ, MQQ, OEC, OKX, CLW, LWK. DXers: W9FVI, LSW, JIP, CKG, TE. W9JTU has worked all W and VE districts on 3.5 mc. W9HIU wants OO, OBS, OPS and money. W9JST reports for first time.

Traffic: W9DUJ 353 HUF 35 HTP 83 HUO 38 HUY 17 HBK 56 AXH 14 DPL 1 DET-EPT 8 EGQ 13 FQ 2 GFS 1 HSF 16 JRK 39 JHY 129 LSB 21 LLV 1 MFU 5 MQQ 3 OXM 23 PDS 2 PEF 10 TE 4 YB 172 JQF 146 HPQ 12 BCP 64 CKG 8.

OHIO—SCM, Harry A. Tummonds, W8BAH—Chief RM, W8PO. W8GZ again leads the state. Dist. No. 1: W8HC has QSO cards for Cleveland hams from Spain. W8EBJ has new QSL. W8GKG reports on 28 mc. club. W8BON, RM, handled Florida state fair traffic. W8AES got a job at Lorain. W8CIO operates on eight different frequencies. W8RN will go sailing soon. W8KZL is new reporter. W8EBI will be OPS soon. W8BTF has new call book. W8HGE works at Cleveland Clinic. Army schedules keep W8EBY busy. New transmitter at W8DAT. W8KJK is on 3861 kc. W8DVI joins Cleveland Crystal Club. W8GUL finally got a crystal. Ex W8OT is now W8EMO of Detroit. W8EJ is commander of Youngstown Naval Reserve. W8EEZ was appointed RM of Dist. No. 2: W8GGF reports activity of Y.M.C.A. Wireless Association of Ashtabula, which has 30 members and 12 licensed amateurs including W8CRN, LKY, GDP, HVK, LAC, LLE, EJY, GGF, LJR, LIO, BNI, DZV. Meetings are held each Wednesday night. W8ANU reports activity of new radio club at Warren. Dist. No. 3 RM W8APC: Welcome report from W8CQC of Toledo. New OPS: W8CMY, W8FUO. W8JR is 100% c.w. W8GOD uses low power phone on 3920 kc. W8ESN was appointed RM for OPS Dist. 3. Dist. No. 4 RM W8UW: W8HMH wants to join U.S.N.R. Ex-W8KCC is now W8JBZ at Deshler. W8PO is getting ready for portable test. W8DDM wants to sell his Philco converter. W8WE has a power leak for sale. Dist. No. 5: W8KLP announces hamfest for East Liverpool, about April 14th. W8BDG is doing good job as O.O. W8HCS is new ORS. W8FGV, RM, handles ORS tests. W8AMF has three schedules. Dist. No. 6: W8DZO applies for OPS. W8GSO, Acting RM, joined A.A.R.S. W8ISK will be ORS soon. W8GZ handled storm emergency traffic for W. U. W8LCO is back on the job. W8AEL has lots of radio service work. W8GDC is at Ohio State Police radio school, Delaware, O. W8ARW uses class A prime. W8IZQ is working on hamfest. W8VP is RM Dist. No. 7. Dist. No. 8, RM W8SPV: New tritet at W8FSK. Welcome report from W8KYQ at Portsmouth. Ohio rebuilders: W8FFK, EPP, KWJ, JBI, EQV, BAC, FGC.

Traffic: W8GZ 751 RN 589 CIO 445 GOD 271 ISK 264 HCS 205 GSO 186 AES 176 HWC 153 BOM 119 FFK 114 BDG 93 EPP 92 EQB 89 GKZ 78 EBJ 52 AMF 38 GUL 35 BAC 34 GME 32 DVI 30 KJK 24 DAT 21 EBV 18 IZQ 15 HMH 14 EJ 13 UX 12 FGV-HGE 11 BWW 10 KWJ 7 ARW-LKT 6 EEZ 5 PO-JBI 4 FGC-CMY-GDC 3 AEL-BFT-HBI 2 LCO-KZL 1 ANU 21.

KENTUCKY—SCM, Carl L. Pflumm, W9OX—SAY, did anybody hear any Kentucky sigs during January ORS Party??? See "Ten Highest" scores! W9OFE, lowest-powered Ky. ORS, takes traffic honors this month. Armed with "push-button QSW," W9BWJ is ready for all contests. W9ARU is experimenting with new feeders à la Feb. QST. Radio service QRM at W9ETT and EOM. W9CNE is preparing for 56 mc. work. Florida State Fair keeps W9BAZ supplied with traffic. W9AQV is working in Louisville. W9KKG blew up two new '03As, and laughs! W9EYW's 3.9 mc. 'phone reaches England. W9CDA is warming up on a mill. W9BAN is grinding 7 mc. crystal. W9ELL handled death message from Governor of Hawaii to Ky. Governor. W9NWR gets in traffic swim. W9HCO opens up on 14 mc. 'phone. W9EQO-JYO

are opening radio service shop. W9ALD is new ORS. W9OMW wants ORS. W9KPT has new receiver. W9FZV says FBX no cure for local QRM. W9DGN and GAQ have 1.7 mc. 'phones. W9KOX is wrestling with 7 mc. antenna. W9IXN's noon-day signal is becoming famous. W9FLM opens up in St. Matthews. W9FQQ found a job at last. W9ETD takes LBX's receiver to Florida with him. W9HBQ is remodeling transmitter. W9EAX returns to air. W9CIM is returning to Winchester. W9DPW says DX elusive. W9NBD finds its plentiful. W9JL, MKP, EDQ, IPG, MVR are rebuilding. W9HNV, AUH, FGK, HAX, EDV, EI, ACD, NEP, CKH, GON report. Let's have more interesting dope on your report cards, fellows, and if you don't get "Ether Clippings" every month, it's because you didn't report.

Traffic: W9OFF 520 BWJ 345 OX 209 BAZ 205 CNE 114 ARU 113 ETT 108 HAX 98 EDQ 57 IXN 53 ALD 50 CDA 49 BAN 45 OMV 36 AUH 35 JYO 30 FGK 29 FRH-KKG 27 ELL 23 HBQ 18 LBX-FQQ 17 NVR 15 EQO 14 EOM 13 PLM 12 KPT 10 ACD 8 CKH 7 FZV 6 IPG 5 HCO 4 MKP 7 DGN 4 AQV-KOX-EYW 3 NEP 2 EDV 1.

MICHIGAN—SCM, Kenneth F. Conroy, W8DYH—W8FTW, DZ and CEU make BPL. W8GUC misses by three messages! W8DVC is right up there too. W9PDE is newest ORS. With deep regret we record the passing of Lt. Lowry of Selfridge—lost his life flying the mails—Lt. Lowry was known to us hams as "Dud" of WYE, W8KY—a real soldier and a real operator. W8JO reports UP/LP Michigan QSO Party successful in spite of skip, QRN etc. W8SS has been elected chairman for 1934 D.A.R.A. spring Hamfest—May 20th. W8CEV is now chief at WMO. W9CWR awaits a crystal. W9HIS and W8QT intend rebuild. Kalamazoo College Hamfest March 10th—says W8BTP. W8GQS didn't know a YL could ever keep him off air! First report from W8KJP, GOV, KNP, ND, GJF, DEE, W9LKR. W8EGI bums reports from W8BNS, ENQ, ZC. RM W8FTW sends in a pile collected via radio. RM W8BMG claims it's so cold he had to put heater in amplifier tank to keep the soup from freezing. W8CUX, we are glad to hear, is up and around. W8JO and FUQ are still after those Conservation Department Questionnaires. W9DRR is preparing dope on twisted wire feeders. W9LKV reports W9LNU and MJW across street from one another. W9LLD kicks on poor WX. W9KDE expects two new hams in South Range. W9CE had blizzard and high-wind spoiled QSO party. W8LAL tells us W8DWB pounds brass all day and then comes home and pounds and calls it fun! W9MJW expects to be back soon. W9MXN is on with c.e. W8GSP schedules W2SN NCS for Boy Scout Mobilization. W9ADY schedules W9CE. W9IOV is still depressed. W9NEZ's new jr. op takes time! W8KOX hoots for W8JO's forest-fire work. W8HBZ is getting the traffic bug again. W8CTD hopes that the fellow using his call on 14 mc. gets him a WAC! W8FII takes DNM's place while Frank rebuilds. Wonder why they thought W8CAT was suited for a night-watchman's job? Hi. W9OVX pounds 'em out at Iron Mountain. W8HXT hooked ZL2AC! W8BHH is building new 11 tube super! W8KPL is another ORS—more needed. W9FBC says the Mohawk gang want more watts. W8ICM uses umbrella antenna! W8ESH's brother, W8FVP, QSY'd to W6 district. W8JK went to Germany. W8IGA is our latest OBS. W8DIV is Michigan Official Phone Station No. 3. W8FDX handles his schedules in a.m. before school. W8ESJ is the man who handled 100 and forgot to include call on report card. W8ADU is after an ORS. Mrs. W8ADU is getting the ham bug! W9JCN likes to send 88 to W9OZM's YL via W9OZM! W9CWD has been nominated to be UP OPS RM. W8DPE is rebuilding for W8FQG. W8CM wants to know if the D.A.R.A. Bull means that it's derribe—Hi. Copy of Bulletin containing dope on all stations reporting to SCM on 16th of each month is mailed free to each station reporting their activities. W8IDB is Unit CS for Unit 4 U.S.N.R. D.A.R.A. voted enough paper and stencils for 10 more issues of the Bulletin—get yours.

Traffic: W8FTW 981 CEU 618 GUC 497 DVC 356

AEQ 220 EGI 192 DZ 130 FX 106 DNM 92 BMG 89 DWB 84 QT 75 BGY 63 LAL 54 BEH 43 DYH 40 IDB 37 FIJ-GJF 34 GRB 33 HXT 32 DEE-ERX-GRN 28 GSP 26 AYO 24 CAT 23 DED 22 FDX-IFQ-KNP 20 KQT 19 ARR 18 IHN 17 JO 15 CU 16 CFM 14 BTK-FAV 13 IGA 11 IYN 10 HPL 9 CSL-DSQ 8 COQ-ICM-JCS 7 AW-BNS-FXB-HTA-IFD-IOR 6 AIJ-BJ-KMT 5 GOV-HBZ-HSJ 4 ADU-BTP-CTD-DPE-EVJ-GQS-HSH-KOX 3 EFI-ENQ-JVI-KSY-ND-WR 2 ZC-FHD-FWG-IXM-KJP-KXT 1. W9PDE 211 ADY 95 CE 46 OZM 35 CWD 22 HIS 12 OVX 8 KDE-LUU-NEZ 7 FBC-IOV-MXN 6 MJW 3 LKJ-LLD 2.

WISCONSIN—SCM, Harold H. Kurth, W9FSS—W9HTZ uses Goyder Look. W9GWK uses flea power at "U." W9JDP had visitors. W9OKS is working up 'phone net. W9EXH, AKY, HSK contemplate 1.7 mc. 'phone. Our sympathies to W9PJS on loss of his father. W9IFS is going to Lax Teachers College. W9EWF uses Universal antenna coupling. W9FSS is going to Univ. Extension Division. W9AKT reports for Madison. W9IQQ and IHB are rebuilding. W9HBH and JLG have BC first tickets. W9HMX will increase power. W9GVL made general overhauling. W9IQW has schedule trouble. W9KJR suggests new RM District for No. Wisc. Is W9GPX a railroad operator? W9OTL uses grid modulation. W9FAW turns to 'phone. W9HRM visited W2 hams. W9OXD remembers meeting the SCM. W9JWV is over a siege of YL-itis. W9EHD-HA teaches radio at Lawrence College. N.W.R.C. presented movie on radio interference. Lax Club meets at "SOS" Radio Store. W9DIT: QRL YL. M.R.A.C. is holding another QSO Party.

Traffic: W9HTZ 138 GWK 132 JDP 108 OKS 79 ZY 11 EWY 14 EXH 3 HSK 76 FSS 89 NSM 64 AKT 60 DRO 44 HMX 43 GVL 40 IQW 39 DEK 32 KJR 30 ATO 29 LFK 18 ETM 13 OTL 3 GPX 4 FAW 1.

#### DAKOTA DIVISION

NORTH DAKOTA—SCM, Wm. A. Langer, W9DGS—W9GER is building 1.7-mc. 'phone. W9PDC is new ORS. W9FSF reports a former Navy op at W9PRU, Langdon. W9PAI and PGO are ORS applicants. W9KBE reports nice score in ORS Contest. W9KZL finds impedance matched antenna coupling FB. W9PJT and KZL visited W9PGO, PAI and KFVR. W9BTV uses one of the new intermediate tubes in buffer. W9LES reports a homemade CQ machine. W9DOY gives us low down on Fargo gang; three newcomers there: PKG, PQW and PUE; JVP and DOY are playing with flea-power 'phone. W9ASF is rebuilding with '03A in final. W9JVP and the SCM have new FBXA's.

Traffic: W9HJC 231 DGS 216 GER 74 PDC 63 FSF 61 PAI 58 PGO 45 JAR 40 KZL 10 KBE 21 BTJ 5 LHS 8 PJT 2.

SOUTH DAKOTA—SCM, C. B. Miller, W9DKL—W9DGR tried link coupling. W9CRY added Buffer-Doubler. W9HSY worked K5AA. W9GYG reports new Jr. opr. W9FLO is building '10 P.P. rig. W9CFU reports new antenna. W9PHD reports new YL at his station. W9IQD is overhauling. W9FDD is going to Western Union School at Bloomfield, N. J. W9KCU is back from C.C.C. Camp. W9IEK has new 50-ft poles. W9AQB is on 3.5-mc. c.w. W9DKJ has 3 weekly schedules. W9PQF has 132-ft. current fed ant. W9PHP and IRO are QRL school. W9CAU has op job in Louisiana. W9PRX is on 3650 kc. W9DKL moved to St. Paul. W9FOQ has c.c. rig on 3.5, 7 and 14 mc. W9CAU, IEK, IRO, PHP, KCU and PRX have all been students in W9DKJ's physics classes. This report written by W9FOQ.

Traffic: W9CRY 10 HSY 69 FOQ 77 DGR 5 TY 48 FLO 9.

NORTHERN MINNESOTA—SCM, Robert C. Harshberger, W9JIE—New A.A.R.S.: W9OOU, OSR, IDJ, HNS, HDN. W9IPA is acting Alt. DNCS for A.A.R.S. W9HNS will soon have new Pfanstielh Super. W9FTJ schedules W9OEG, Hope, N. D. W9HNS schedules PCU and IPA. W9JIE works K6 on 3.5 mc. c.w. W9BBL could not find any OPS on 14-mc. 'phone. W9IPN likes Collins

Antenna Impedance Match circuit. W9BMX works 14-mc. DX. W9OMI has "push-to-talk" system on 1.7 mc.

Traffic: W9HNS 20 IPA 97 000 1 HDN 15 JIE 6.  
SOUTHERN MINNESOTA—Acting SCM, Francis C. Kramer, W9DEI—W9BKK has new FB7. W9BKK's new tri-tet keys FB. W9BN sends nice total. W9DEI worked Belgian Congo. W9FCS has a new c.e. rig. W9AIR is building rig for next Field Day. W9DIE keeps several schedules. W9MOV sends first report. W9OAK promises more traffic. W9BNN is active on 3.5 mc. W9EYS was reported off-frequency, but was not on the air. W9FNK works lots of DX. W9EYL says QRN on 3.5, QRM on 7, so he has QSY'ed to 14 mc. W9OQA and AQH are QRL. W9KDI is going to take unlimited 'phone exam. W9IDF, LEN, and ANU are rebuilding. W9EAH is selling out. W9CSY reports from "the land of sun-tanned beauties," Florida. W9QA says living in an apartment is bad for ham radio. W9ADQ has c.e. rig going FB. W9DVH puts 110 watts into a pair of '10s. W9MGY has an 825 working nicely. W9NHX and DVH blew power transformers. W9GLE's Hartley gets good results. W9EPJ is pounding the ivories in the Union Hotel, Alma, Wis. The Faribault gang is planning a QSO Contest. Kindly send future reports to W9DEI, St. Charles, Minn.

Traffic: W9BKK 588 BKK 554 BN 128 DEI 102 FCS 70 AIR 61 DH 59 MOV 20 OAK-BNN 16 EYS 10 FNK 8 EYL-OQA 6 AQH-KDI 2.

#### DELTA DIVISION

ARKANSAS—SCM, Henry E. Velte, W5ABI—W5BMI runs up a very nice traffic total. W5CPV reports for Camden gang. W5DFL, DJE and CVO get out well. W5DTI reports for first time. W5DHV traded his receiver for another, sight unseen, and says "Wotta Sight!" W5DRZ made himself a bug. W5DEN is moving to California. W5DRW has DEN's transmitter. W5ABL works DX on 14 mc. W5BDB is on 14 mc. 'phone. Following are on 1.7 mc. 'phone: W5AXP, BUX, DSW, DFZ. W5BUX has been appointed OBS. W5BXM has a new 800 tube. W5CSN and CCW use '52s. W5CR has flea power 'phone. W5BSG is QRL school. W5CCW is now WAC. W5DRV is reappointed ORS and RM. W5CZG is new ORS. W5DYT is new Hot Springs station. W5DRZ is putting in c.e. W5DHW is building 'phone.

Traffic: W5BMI 1179 BUX 370 BXM 105 BZK 60 DHN 25 ABL 13 ABI 10 DSW 5 DHG-BDB 3 CLQ 2 DFZ 3.

LOUISIANA—SCM, W. J. Wilkinson, Jr., W5DWW-VT—W5AXU heard K6 on 3.9 mc. phone. Rebuilders: W5AFW, DMF, BFL. W5DVP is located at Barksdale Field, La. W5BRZ visited SCM. W5BPL had a visit from W5AZV. W5HR heard in ZL on 3.9 mc. 'phone. W5BMM worked J1D0. W5AOZ is Activities Manager of N.O.R.C. W5AEH built c.e. rig for N.O.R.C. W5ABS ground crystal for the rig. W5DKR reports for them. W5BYY (Lefty) has "tear up" fever. W5CEF and DWW formed the Audion Club. Write for information. W5CEN likes s.s. receiver. W5CTR has 250 watt rig.

Traffic: W5AFW 170 BZR 83 BID 66 HR 30 BYY 12 DVP 9 AXU 8 BMM 3 CTR 6.

TENNESSEE—SCM, F. F. Purdy, W4AFM—W4BPC was appointed OPS. W4PL, RO, BBT, AFM handled much W4CI Florida Fair traffic. We believe W4PL's total surpasses any previous in this section. W4BTT will handle W4PL schedules till PL gets back from fishing trip. W4CBA is active on 7 mc. W4KA is putting up and taking down sky wires. W4FR is helping to rebuild WDOD. W4BIR has trouble with landlords. W4A40 will soon be around Fort Ogle to help BIZ. W4CBS is still with TVA. W4EX reports BXQ and CHI working DX. Another fine report sheet from W4AYE. W4BM is interested in 28 mc. 'phone. W4AHN is on 3.5 mc. W4ACU is running down QRM complaints. W4BEG works at WSM. W4AYE finds that an 82 rectifier won't stand 1000 jolts. The Nashville gang is planning on organizing a club again.

Traffic: W4PL 1566 AFM 1143 RO 801 BBT 338 EX 30 BQK 27 BPE 13 AYU-ACU 12 BM 11 BTQ 10 CBA 8.

#### HUDSON DIVISION

EASTERN NEW YORK—SCM, Robert E. Haight, W2LU—W2BJA, Chief RM, continues his high totals. W2EGF's homemade bug won 1st Prize at Radio Club. W2CLL reports antenna coupling method by W9CXX perks FB. ORS appointment awaits W2ETH. W2BLL applies for OPS. W2UL celebrates 10 years in ham game. W2CC becomes Uncle Al upon arrival of Jr. op at W9WR (SCM Illinois), his brother-in-law. Congrats to W2QY as our Section's first OPS. W2CD contacts LA1G on 'phone. W2GNI wants NYC schedule. W2BWB is going on 1.7-mc. 'phone. W2FPH is back on 3.5 mc. W2ACY is all set for DX Contest. W2FXC hopes to be with NCR soon. Power leaks and QRM at W2BRS. W2CJS worked all districts and 31 states on 3.5 mc. W2ESO is back at college. W2GFD uses 14-mc. vertical antenna with twisted lamp cord feeders. W2BNR builds pillbox portable. W2BVR is back in town. W2DSH applies for ORS. W2CVL is secretary Tri-States Radio Club. W2GTW is new ham. W2FCQ reports for Westchester Radio Club: pres., W2EVJ; vice-pres., W2EAS; secy., W2CPQ; treas., Henry Rebe; W2GAZ club station. W2KW was froze up in 47 below zero WX; key froze fast. W2ENY is pounding away. W2DUG is after WAC. W2BSH enjoys 4-way QSO—W8DSS-W8JW-W2CRT. 1.7-mc. 'phon stations at W.P.: W2EVJ, DVY, BSD, BWS, GAZ, port., W9KZQ and W2CSM.

Traffic: W2BJA 230 EGF 159 LU 108 BVR 23 CLL 22 ETH 20 BLL 17 UL-CC-QY 12 DC-GNI 9 FPH-BSH 6 ACY 5 FXC-BRS 4 CJS-ESO-BNR 2 GFD 1 CJP 13 FEQ 21.

NEW YORK CITY AND LONG ISLAND—SCM, Ed. L. Baumach, W2AZV—W2EGA is inventing new type RF amp. W2EWS invents robots. W2FDQ is drafting plans for new rig. W2FBP has FB c.e. rig. W2CEH's YF has been taken ill and has gang's hearty hope for recovery. W2FST is improving c.e. rig. W2EYQ anxiously awaits next ORS party. W2AXN says jobs are scarce. W2EQA has new receiver. W2FHB is wrestling him in receiver. W2BEG is starting plans for 1934 Hudson Division Convention. W2CHK was snowbound in his shack during recent snow storm. W2EYS sends a high total. W2BGO complains of summer QRN. W2EBT reports good performance with Grammers' Amp. unit. W2CUH is building MOPA for 7 mc. W2DUP worked his first W6 on 3520 kc. W2BPJ worked the S.S. *Minnequa* KIVB 25 miles south of Cape Race. W2DOG was heard in England on 3.5 mc. of the Cape Race. W2BSR and UK are rebuilding for DX Contest. W2UK is experimenting with Collin's coupling system. Power leaks bad at W2AEN, W2FIP and CAW are out for ORS. W2CCD operated with the temperature at 47 below at his up-state station. W2EKD is out for WAC. W2DWW has frequency monitor. W2DJP is working on c.e. rig. W2BTF has BCL QRM. Deliveries keep W2ELK broke. W2AYJ says conditions are punk. W2BRB has been experimenting on very high frequencies. W2EDZ reports two new stations, W2GUA and EQU. W2ERH is trying 28 mc. W2FDU has new Comet Pro. W2ETG reports for the Stuyvesant High School. W2CLE, the school station, has a '52 on 7 mc. W2FBF is on with low power. W2GAO is now c.e. W2BHD and ETG build tritets jobs. W2GPR is working VK's. W2BHD and DPH are graduating from H.S. W2CYA went back to c.w. W2AZV has crystals for all frequencies. W2FBE works CM's with a '10 on 7 mc. W2ECJ is out for OPS. W2BMH will be 1.7-mc. man soon. W2EVA is going in for high power. W2FCQ is a service man. W2DTT is writing for books. W2PF has antenna problems. W2BAS can't get traffic through any traffic nets. W2GLJ is in the market for an SW receiver. W2EQL uses '45s in P.P. W2DQW and GEI have trouble in trying to get any stations to QSP. New officers of Manhattan Radio Club: W2CWP, pres.; W2FHD, vice-pres.; W2GBM, secy.

Traffic: W2CHK 491 EYQ 218 BGO 197 EYS 291 EYJ 193 ELK 188 BTF 152 DJP 128 DWW 86 BNJ 48 EKD 45 DQW 41 LB 40 EGA 36 AZV 35 ADW 29 CCD 31 PF-BAS 23 CYX 27 FIP 24 GZ 21 DBE 15 CAW 14



AEN 13 FDQ 12 DOG-EQL 11 DUP 10 ASG-ALD-AA-DKP-CIT-BFA-KH 9 BPJ 8 LC-CWP-EYB 7 EBT-FBP-CEH 5 FST-BNL-ALZ-CAU 4 CUH-AGC-CPY-BVT-LA 3 GEI-GPR-ETG-EDU 2 GAO 1.

NORTHERN NEW JERSEY—Acting SCM, Robert Maloney, W2BPY—W2EKM continues his fine work single-handed, giving 24-hour traffic service to west coast via W5CJL. W2DIU had to curtail schedules to take on additional Army work. A card from V86AQ is awaited at W2DPB. W2CTT expressed dislike of February weather. W2ENZ still manages to duck the local police. W2EVI, visiting W2EIC, got bitten with hi-voltage and put EIC off the air. W2BCX puts Elizabeth up where it belongs. W2BXM schedules W8CFI. A new Comet Pro at W2DPA. The W2BSC gang have nothing to do until next exam time. W2BAI transmits one way to his father, W2QW, who is listening to him in Florida. W2AWU, CGG and DGU are active on 3.5 mc. W2CIM works at the Clifton Sylvania plant. New high-power rig of W2ESX will soon be heard. W2CLM displays a Class A ticket. Hillside comes through via W2LK. W2EXQ delivered two messages ten minutes after receipt from W4AJX. W2AMR is back from seven months' stay in Panama. W2GLB joined the Bell System, Decibel Radio Club. The A.A.R.S. claims another victim in W2AFK. W2EXY, former 2CP and RM of this Section, will be back on. The Memorial Radio Club edits a ham radio feature in several local newspapers. W2DNX sends interesting dope on the Passaic County A.R.C. and informs us they have called off their banquet. The Tri-County gang has been presenting some ultra-sophisticated entertainment at their meetings by importing musical Rabalais, MIM. The Raritan Bay Radio Club installed a 1.7-mc. 'phone at a local aviation show. Two new clubs in this Section are the West Essex Radio Club at Verona and the Bayonne Vocational School Radio Club. The latter club includes in its membership Harold Mays, W2FDS, who trains with Primo Carnera—wotta fist that boy must have! W2BPY wishes to hear from Kernie, W8BJO.

Traffic: W2DIU 1472 BCX 1227 EKM 955 DPA 20 CGX 38 CJX 26 ENZ 33 CTT 5 DPB 23 BXM 4 BAI 13 EGY 7 FOP 27 GCC 2 AWU 5 DGU 29 AMR 5 EXQ 9 LK 30 EIP 10 CLM 2 BSC 209 DVN 24 AFK 207. (December-January: W2DIU 3101 BCX 1353 EKM 953 CTT 7 ENZ 283 CJX 14 DPA 74 BXM 1 ELJ 22 DPB 7 EIP 6 AWU 4 LK 106 FDD 40 AFK 230 DVN 35 BAI 61 FXE 16 CLM 1 BSC 157.)

#### MIDWEST DIVISION

IOWA—SCM, George D. Hansen, W9FFD—RMs, W9ABE, W9HPA. W9ABE cops first honors. W9LEZ rates BPL for first time. W9EIV hits another good total. W9HMM handles some Byrd traffic. W9HPA is organizing a National RM Net. PLEASE SEND W9HPA A LIST OF YOUR SCHEDULES. W9CWG mentions the "Ia. Tfc. Net." W9FYX has some good schedules. W9FYC reports new ham, W9FND. W9ERY built new c.c. Dyn. Monitor. W9GWT favors ORS roll call. W9GXU reports schedules going great. W9JCS is at college. W9FFD gets on only for U.S.N.C.R. drill. W9GSY says QRN getting worse. W9FQT is active in U.S.N.C.R. drills. W9IO-YA reports 'phone has them in its grip. W9JMB says QRL P.O. Exam. W9NTW is going to St. Paul for Class A Exam. W9KTP has 1.7 mc. 'phone at C.C.C. camp. W9KMJ has trouble getting the old rig on 'phone. W9BHO, Father Peters, was heard in New Zealand on 1.7 mc. 'phone. W9LCE gets more output with new '10 buffer. W9CYL pumps 220 watts into the old 50. W9DIB is on 7 and 14 mc. W9MCD, OGT report for first time. W9NEC is getting interested in traffic.

Traffic: W9ABE 755 LEZ 245 EIV 165 HMM 147 HPA 122 CWG 110 FYX 80 FYC 87 ERY 63 GWT 23 GXU 20 JCS 17 FFD 15 GSY 12 FQT 10 IO 7 JMB-NTW-CYL 4 DIB 2.

KANSAS—SCM, O. J. Spetter, W9FLG—W9KG CW RM. We regret to announce that RM W9CFN has found it necessary to resign. W9ESL Phone RM. W9KG leads the Section. Rebuilding: W9OQC, GDS Transceiver; COA

c.c. rig; OKA '52s PP PA; BUY Class B. W9PGL has '48s in final. W9FET uses tritet. W9CYV has c.c. on 3.5 mc. New receivers: W9CVN, Patterson Super and FBX; LVZ, Comet Pro. Working DX: W9AFP. New appointments: W9JUT, OO; ESL, OPS. New calls: W9POR, PUX, GXD on 'phone. W9FMX and AWB are trying 56 mc. W9DMF, LVZ, and BSX are on 7 mc. W9HWW, Armory, is back on with five operators. W9IGY, HTF, and PPC report QRL. W9ESL handled message for the Governor. W9JDJ has '03A final. W9MUY is going to California. W9GBP burnt out power transformer. W9KQJ is out of hospital again. W9FRC is grid modulating 211. Club news: W9BEZ demonstrated Patterson Super at W.A.R.C. meeting; eight members of Kingman Radio Club were visitors at Feb. 15 meeting of W.A.R.C.; W9FRW was recent Sunflower Club visitor; H.A.R.C. gave Amateur Radio Demonstration at Hamlin High School Jan. 26th; W.V.R.C. plans joint meeting with Key Clickers Club of Ponca City, Okla. and W.A.R.C. W5CQI is new W.V.R.C. member. W.V.R.C. officers: W9NJS president, LKM vice-president, KTTJ secy.-treas. For more full reports see Kan-Ham last month.

Traffic: W9KG 1258 IQI 526 IOL 509 FLG 478 GBP 472 OQC 383 KQJ 316 BYM 287 PB 230 EFE 199 JDY 187 NJS 155 IEL 104 OFR 102 ICV 98 FRC-AWP 31 BUW 22 CNW 20 CMV-LWP 16 KFQ-EYY 12 MUY 11 OKA 10 LRR 7 COA 6 AWB 2 ESL-HJF-FMX 1 LGR 8.

MISSOURI—SCM, C. R. Cannady, W9EYG—RMs W9CJR, W9NNZ, W9BMA, W9BGE and W9FTA. Kansas City paced by W9NP—BPL THIS TIME—leads all clubs in traffic with rural Missouri leading Kansas City and St. Louis combined! St. Louis—O.B.P.: W9BGE is trying to get T.L. for St. Louis. W9AC is out of city. W9BZN is new member. W9ZK continues 3.9 mc. 'phone. W9PW is QRL business. W9EZK worked first VK on new rig. W9EFC wants quarantine so he can finish new rig. W9AAU got new job. A.R.F.: W9GTK reports club activity down. W9LTH has c.c. rig with link-coupling. W9GUQ is building for high power. W9CCZ gets first VP4. W9LLN sticks to 3.5 mc. W9FAB has new job. W9NBV has new 50 watt c.c. rig. W9NBE is on 1.7 mc. 'phone. St. L.A.R.C.: W9HVC is looking for schedules on 7100 kc. W9KEF sends OPS application. Kansas City—W9BMA applies for OPS. W9EL and CVP built new 14 mc. 'phone rigs. W9LD and BKO did same for 3.9 mc. W9RR, NP, CFL and ZZ send FB USNR reports. W9FFR sends in first report. State News—S.M.A.R.A.: W9EUG is QRL work. W9CJR holds ten schedules. W9IXO is getting ready for DX contest. W9EYG is back at Monett. W9FYU is home from Ark. U. Ozark: W9ENF is building tritet. W9GLQ reports club activities—W9CRM says conditions exceptionally good. W9GBJ and HNM: QRL. W9AQX holds seven schedules. W9NNZ met with nine other hams at home of W9DIC, Moberly, for FB hamfest Feb. 11. W9AJJ had misfortune of losing little finger in encounter with electric drill. W9JAP is rebuilding. W9EDK is trying 1.9 mc. 'phone. W9DLG gets OPS appointment No. 2. W9DHN is QRL M.U. W9NLJ sends FB report. W9KCG gets FB results with zapp and indoor feeders. W9OLC reports for W9BTD, KPM, JLX, DHX, all of Fulton. W9GGY is getting back to regular operating hours. W9NPQ-GCL comes back to Mo. after three years in Leavenworth at WVC. LET'S INCREASE THIS REPORT NEXT MONTH, GANG!!! 73.

Traffic: W9CJR 368 NP 275 NZ 243 ENF 181 BMA 135 RR 130 GTK 102 AQX 87 HUG 49 CRM 34 LLN 33 OLC 26 EYG 16 EFC-BGE 14 GLQ-ZLK 8 DOE-FFR-JPT-DLC 7 CFL 6 PTA-ZZ 5 EZK-NLJ 4 KCG 3 HVC-IXO 2 JAP 1.

NEBRASKA—SCM, Samuel C. Wallace, W9FAM—W9BNT has been QRL changing QRA. W9DEF schedules W9DGS, GJQ, IOL, CMV, EWO, FGS, DHA, EIZ, EXP, KVN. Some list! W9FYP, OPS, is going strong on 1963 kc. W9EWO's eyes are going back on him. W9DMY keeps his batting average up. W9FAM schedules W9KPA. W9JED works both c.w. and 'phone.



W9DI is back in school at Lincoln. W9DHA has been under the weather with his tonsils. W9OPP reports for W9DHO. W9DHO is busy playing in orchestra. W9DGL is the Official DX HOUND of Nebraska. W9FXP is rebuilding to higher power. W9EHW schedules W9CUY, FWL, DJ and DZK. W9IFE has been leading Nebraska this season with his traffic. W9KPA has reliable schedule west to Salt Lake City and Los Angeles. W9CUY is QRL buying cream and hens. W9JEE sends his traffic report regularly each month. W9DLK, the VOICE OF HOWE, is getting the fever again. W9MKG reports new Radio Club coming along nicely. W9DTH is back with new outfit.

Traffic: W9BNT 621 DFF 285 FYP 228 EWO 220 DMY 212 FAM 157 JED 147 DI 105 DHA 47 OPP 24 IFE 1014 KPA 544 CUY 119 JEE 86 DLK 28 DHO 9.

#### NEW ENGLAND DIVISION

CONNECTICUT—SCM, Fred A. Ellis, Jr., W1CTI—WIAMG takes back first place in traffic. W1FIO worked out a fine break-in system with high-power transmitter a few feet from receiver. Fireman Gil has to leave W1CJD in a hurry sometimes to go to a fire. W1GME handles his share of traffic! W1GCG handled a bunch of Florida State Fair traffic. W1BDI had a cold trip to Boston Hamfest. W1DGG cancelled all schedules until after DX Contest. W1DOW added a schedule. W1GGX keeps Bridgeport on the map. W1APW has good route for west-bound traffic. W1BHM is now with New Haven Bank NBA. W1TD revamped old transmitter. W1SZ has gone back to Tuesday night operation—7 p.m.—1 a.m. on 3.9-mc. 'phone. W1FXQ reports a new ham, W1HVG, Hartford. W1EWD is getting ready for DX Contest. W1GKM has good schedules. W1HAG has trouble with his note. W1BNB enjoys himself on 1.7 mc. W1AKG plays a cornet in BFS's orchestra. W1CLH received a report from KAINA as having heard his signals the long way around. Hamfest held by Harold I. June Radio Club at Stamford Y.M.C.A., Feb. 3rd, went over in fine shape. A. L. Budlong of A.R.R.L. and Lieut. John Reinartz gave talks. WIAMG acted as toastmaster. Conn. Brass Pounders Association, W1CBA, will award a banner to Connecticut station handling the most traffic each month. This banner will remain in the possession of the station leading the state for one month, when it will be transferred to the next winning station, on the order of the SCM. The following stations will be excluded from the Contest: WIAMG, CJD, CTI, FIO, MK, BHM, AFB, BDI and UE. W1GME wins the banner for month ending Feb. 15th. CBA will sponsor a unique frequency measuring contest soon. Watch broadcasts Sundays, 9:30 a.m., WIAMG, and 10:30 a.m., W1CTI, for up-to-the-minute Conn. dope.

Traffic: WIAMG 563 FIO 402 MK 374 CJD 345 GME 208 UE 187 GC 184 BDI 139 DGG 128 DOW 100 GGX 95 CTI 89 APW 75 BHM 30 TD 17 HAG 11 HJW 9 GTW-GKM 6 HSU-GUC 5 SZ-FXQ 4 BWM-EWD-HLE 3.

MAINE—SCM, J. W. Singleton, W1CDX—W1BOF is back in the lead! W1EF was "QSP" between the Coast Guard and Bar Harbor and aided in rescue of a man who was adrift in a small boat. W1CDX is handling a few. W1EBM works west coast on 3861 kc. W1FJP busted his crystal. W1GBM has good schedules. W1OR is about ready to go with high power. W1BTA uses 4 '45s. W1HUX plans a P.P. '45 rig. The Lewiston gang put over a very fine hamfest on Feb. 17th. W1CEQ works a little DX. W1BWB has trouble with c.c. rig. W1FXA has a dandy c.c. job on 7 mc. W1ABQ is working hard on U.S.N.R. W1ELE handled a good string. We extend to W1CFG our deepest sympathy in the passing of his mother.

Traffic: W1BOF 192 CDX 129 EF 94 EBM-ABQ 62 GKC 53 ELE 45 DFQ 49 FJP 31 GBM 29 OR 17 BTA 11 HUX 3.

EASTERN MASSACHUSETTS—SCM, Joseph A. Mullen, W1AS1—W1VS again leads the Section. Close on his heels is W1CRA. The Section now sports a YL in the ORS ranks, W1FRO. Welcome, Alice. W1KH and ASI

were QRL hamfest. W1WV is on 1.7 mc. W1EVJ is in position to give you all the dope re schedules in the Section. W1DFS is laid up with bronchitis. W1RE is lining up a route from here to Byrd Expedition going via Kansas. W1EMH applied for ORS. W1JL is going after ORS again. W1DNF expects to be on all day every day. W1ALP migrated to 56 mc. W1GCL is QRL rebuilding. W1BFR is pounding traffic again. W1DIU signed on as op at WMP. W1CNA is first OPS in the Section. W1DBF is on 56 mc. W1QF is putting in c.c. W1DIH worked a six on 3.5 mc. W1AKF is on 3.5 mc. again. W1CIK is pushing a ¼ KW. W1QM is going big with 'phone on 3.9 mc. About every second ham in New England attended the hamfest in Boston on Feb. 17th. With deepest sympathy we record the passing of W1DYX. Bill Butler was well known as an outstanding active amateur. W1VA reports that W1AC-WAAB will have a pair of RK18's running on 56 mc. about March 1st and will operate 24 hours per day. Reports are requested. W1ZK is puffing after his busy spell managing the Boston Hamfest while AKY and AJA are each 120 degrees out of phase with his puffs, making the sum total pure D.C. W1AKN and CGM spent vacation from school playing around their outfits. Don't forget to start saving your nickels for the Convention to be held in Springfield on May 4th and 5th. They tell us we are going to get two feeds instead of one for the price of the single ticket!

Traffic: W1VS 677 CRA 423 EVJ 127 FRO 113 BZO 99 GCL 95 AGA 68 BFR 51 DFS 31 BMW 32 BEF 29 ASI 22 RE 18 WV 11 CNA 4 EMH 2 JL 1 EVE 41 ABG 33.

WESTERN MASSACHUSETTS—SCM, Earl G. Hewinson, W1ASY—Our Chief RM, W1BVR, leads in traffic with 43 schedules a week. W1DVG handled traffic from Little America. W1FAJ is about to join A.R.R.L. W1HOD is QRL A.A.R.S. W1BXF went to Boston Hamfest. W1EVZ enjoys his Pro. W1GHU is new RM for Worcester County. W1DUS is new ORS. W1EOB is buggy on antennas. H1. W1COI has new transmitter. W1BWW gang is busy on convention plans. W1BNL has '03A working better. W1APL is working hard to make the Convention a success. W1EHR invites visitors in Amherst to his shack. Single wire feed works FB for W1EAX. W1BPT is back on the air. W1EBH finds Zepp feeders directional. W1ZB is getting set for DX Contest. W1ADF is back from the coast.

Traffic: W1BVR 346 DVW 106 FAJ 90 HOD 65 BXF 63 EVZ 58 GHU 51 ASY 39 DUS 35 ARH 24 EOB-COI 20 BWY 18 BNL 8 DLH-OF 7 APL-HHR-EAX 4 BPT-EBH 2 DUZ 3.

NEW HAMPSHIRE—SCM, Basil F. Cutting, W1APK --N. H. is to have its first state-wide hamfest at the Hotel Carpenter, Manchester, on April 7th. Banquet begins at 6 p.m. Among our guest speakers will be Mr. C. C. Kolster, R. I. Plenty of prizes and special features. W1BJF is busy keeping warm. W1HFO is trying 56 mc. W1CUN has worked 30 countries. W1FCI is doing good work in the north country. W1FEX reports a temperature of 55 degrees below zero with a wind of 200 miles per hour on Mt. Washington. W1AEF works FEX easily. W1GOB is a newly licensed ham. W1ET, FHE, FHF, and EWF are on 28-mc. 'phone. W1DVG went home from school for a short time. W1GHT is on 3.5 mc. W1GEG is new OPS. W1BEJ likes his Comet-Pro. W1ANS and AP are on 1.7-mc. 'phone. W1SK is new OBS. On 7 mc.: W1GKE, HGZ, FGC. W1FFL sends a fine total. W1DMD is QRL business. W1FFZ sends consistent reports. W1UN is the star station of northern N. H. W1ANP has BCL trouble. W1HTJ is an old-timer. W1BEO is back in Berlin. W1TP is a service man. W1FGM has new receiver. W1CBB is QRL A.A.R.S. W1CCM is now on c.w. W1AVJ, APK, and W1FTJ are on hamfest committee. W1ERQ has a fine network going in this state. W1EAW is trying new speech amp.

Traffic: W1ERQ 220 FFL 156 UN 138 FCI 75 FFZ 35 CBB 23 GEY 11 CCM 10 CUN 14 GKE 10 BJF 38 APK 27.

RHODE ISLAND—SCM, Albert J. King, W1QR—

WICPV is experimenting on 56 mc. WIDDY, the new RM, is busy lining up schedules. WIASZ is QRL service business. WICAB handles traffic on 14 mc.

Traffic: W1QR 111 CAB 67 CPV 36 DDD 18 ASZ 13. VERMONT—SCM, Harry Page, WIOTF—W1BAS reports "Ad Lib" as usual. W1EZ worked Netherlands on 3.5 mc. The Vt. 'phone quartet, AZV, FFS, DQK, and BJP, are notable for regularity. W1BD peeps up his Army with "Rattlers" and sometimes passes "Dixie Squinch Owls" around, which he gets in trade from Capt. Jones, W4IR.

Traffic: W1BD 109 BJP 69 ATF 164 FPS 43 AXN 138 DQK 53 AZV 21 BAS 16 GGT 43 EBF 13.

#### NORTHWESTERN DIVISION

ALASKA—SCM, Richard J. Fox, K7PQ—K7BZX is building a 100 watt amplifier. K7BNW is back on the air. K7BAQ has gone to the States. K7A1B is a new Ketchikan ham. K7ANQ reports bum conditions. K7CSZ let his license expire. K7BEL visited K7PQ. K7TF is moving to Ketchikan. K7BOE sent "CQ URGENT" and K7ACZ answered, offered services, and arranged through the Navy Station at Dutch Harbor for a plane to pick up a man with frozen feet. K7BOE messages average forty words in length. K7DJA burned up a two KW pole transformer trying to give his P.P. '45 rig enough power.

Traffic: K7BZX 17 DJA 26 PQ 64.

IDAHO—SCM, Don Oberbillig, W7AVP—W7DEB has trouble with parasites. W7BYW is putting '86s in front of '04A. W7CFX needs some '52s. W7BLT pushes tens on 7 mc. W7AVZ is winding transformers. W7NH had a one hour 3 way QSO with W1AMP, K6VG on 3.5 ms. W7CHH increased power. W7CSW is consistent reporter. W7DZC reports for first time. W7CHN visited W7GL. W7BAA QSY's in 10 seconds from 3.5 to 7 mc. W7CQT reports plenty DX on 14 mc. W7CHT reports success with antenna tuning from Feb. QST. W7AAJ reports Pocatello amateurs cooperating with police radio demonstrations. W7BCU reports lots of mud QRM on his mail route. W7KJ visited with W7KY. W7DPP travels 30 miles to Gem State Amateur Radio Club. W7DAW and BAR have fun on 28 mc. W7BRU, EAY, DEQ: QRL school. W7BRY is QRL Army air mail traffic at KCR. W7CZO is painting cars. W7EEZ is active on 3.5 mc. W7AVR is looking for job. W7AT had trouble with speech amplifier. W7JY is enjoying WX at Grangeville. W7AXY took trip. W7KI, ACP, AHS, QRL, C.C.C. headquarters radio. W7AYP works 'phone switchboard at C.C.C. Active A.A.R.S.: W7CUG, DMT, DZO, AFT. New Idaho hams: W7EFL, DFV, EFR. New YFs at W7BLL, BRD. W7BKF turned his Ford over on the way home, escaping uninjured. W7AFH has new 830 tube. W7ARS has 242-A in c.c. W7BQJ has schedule with home town of Malad. W7BAT attends school. W8FQJ is located in Parma. W7DJM has transmitters for 3 bands. SCM asks all to put a circle on the calendar at the 16th of the month. W7BMF holds schedules east and west. W7CHV has T9 sig in Boise. Rebuilding: W7DAY, DKY. New receivers: W7DBP, CJK (PR10). New c.c. rigs: W7AVP, CKO, CSP. Active on 'phone: W7GU, EES.

Traffic: W7AVP 265 CSW 8 CHT 30 BLT 6 AVZ 8 NH 12 BMF 120 BAA 90.

MONTANA—SCM, O. W. Viers, W7AAT—New ORS: W7CRE, DXR. New stations: W7EAQ, EEH, CDK, EDJ, EFU, DHW, EBN, CIZ, CZQ. W7CCR is going back to 'phone. W7AQN has 830's final. W7AOD hopes to add power. W7BDJ plans to build SSS receiver. W7BDC plans 14 and 28 mc. 'phone. W7AFS works DX. W7CEG has P.P. 46's final. W7CDK and AAT are on 3.5 mc. W7CRH wants traffic. W7BDS visited Billings gang, BDC, DXR, DHW, CIZ. W7BYE and OPY "grind their own." W7BHS, Roundup, is on again. W7AST and AYG are on 1.7 mc. 'phone. W7AIR moved to Fromberg. W7CAL visited Forsyth, Miles City and Billings. Active in Butte: W7FL, CKG, BDZ, BDT, CT, BKB. W7DHW uses '47 c.c. to feed antenna. W7EBN has modulator trouble. W7DEN is rebuilding. W7CIZ popped con-

denser on first contact. W7CZQ and DLL are active. W7COX has new tickets.

Traffic: W7CRE 264 BDJ 78 AOD 45 BDC-CCR 40 FL 21 AAT-DXR 11 CPY 59 BDS 7 BYE 5 CEG 24.

OREGON—SCM, Ray Cummins, W7ABZ—Following are the month's outstanding stations in activity based on traffic handled and service rendered: W7MF, DIZ, AYW, CXK, CIK, HD. New reporters: W7DMK, DKI, DHZ, DOJ, DBEL. Rebuilding, adding new equipment, etc.: W7QY, MQ, DP, AQX, ANX, CBA, CFM, DGD, AYN, CVL, KL, BWD, AIG. New official appointments of the month: W7AHZ, 'phone RM, and BUF, OPS. Active in A.A.R.S.: W7AIG, DP, BZS, and BDU. Working DX: W7PK, KR, AIP, AXO, BMA, and CHB. Experimenting with new equipment: W7LT, BKD, CUV, AMF. Out for a rag chew: W7SY, and DIU. Out for traffic: W7BUB, BRO, BOO, BBO, BNK, BXQ, BKL, COU, ALM, ALB, DUE, CTR, DVX, MF, CIK, HD. New c.c. stations: W7UJ and EBQ. 'Phone stations active: W7CX, BEK, BDE, AOI, and AEM. New club officers: Valley Radio Club: pres., W7BIO; vice-pres., BRH; secy., ANB; treas., BGF. Club reporters: W7BRH, CIK, DP, AYW, and CRK. Miscellaneous: W7BLN, GQ, APE, DCI and AQY all cooperate by reporting activities. SCM's message: Above is new form of report, suggested by an eastern SCM. I am experimenting with this simplified form in order to get every reporter mentioned in the monthly report. Please communicate with me and give your comment on this new form of reporting. Are you getting ready for the big 56-mc. Field Days, July 14 and 15?

Traffic: W7MF 343 CXK 331 AYW 306 HD 260 CIK 198 BRH 159 DP 130 WR 147 CFM 137 AIG 77 BWD 88 DUE 68 CVL 51 BKL 50 BOO 32 ABZ 31 ALB 36 ECO 30 ANX 29 AMF 23 CUV 15 COU 14 SY-BUB 12 BNK-DBH 11 DIU-BMA 10 DXC 9 CRA 8 BRO-AYN-AOI 6 CHB 5 BGF 4 AHZ 10 ALM 3 DHZ-DVX-DGD-EBQ-BXQ-BBO-DKI-DOJ 2 PK-AXO-CTR-BDE 1.

WASHINGTON—SCM, Stanley J. Bellevue, W7AYO—W7CZY leads the Section as usual. W7WY says traffic "nets" this month. W7CHH runs a gas station. W7AZI has antenna direct coupled. W7LD gets traffic from the students at U. of W. W7BBK is going to QRO. W7CQI is new pres. of Bremerton Club. W7BHH has new shack. W7DZX clicked a T12 for new country. W7BAD and CQK keep Cheney on the traffic map. W7AHQ plans to get new receiver. W7ABU is new O.O. We could use a couple more Official Observers. W7BUW reports for W7YH. W7AFC renewed ORS. W7DNL clicked first ZL. W7DRD has "YLitis." W7AVL takes traffic from OMITB and a J2. W7AMA and BEV are active on 'phone. W7AAN is Gen. Chairman of the coming Spokane Hamfest in June. W7DGY clicked two new districts. W7DRY reports on new type report card. W7BG has had that call since 1919. W7DZN is going MOPA. W7CCF and DF visited W7IG. W7BUX was reflected prexy of Yakima Club. W7BYB, BCS, AUP, CAM, and DWC are active in Yakima. W7AYO worked several ZL's and VK's. Report but no traffic: W7ECX, APO, CWN, AZA. Report by radio: W7AWF, ECN, DGN, CZY, ECY, AZA, DJJ, CWL, EAW, DVL, BBB, CZK, AGE and EEJ.

Traffic: W7CZY 688 DNL 243 CQI 227 LD 211 AYO 202 WY 160 AGE 143 IG 126 BAD 104 ABY 102 ALH 100 AWF 95 BHH 86 DGN 57 AHQ 36 APS 34 DGY 31 DPU-CHH 30 BBB 29 BBK 23 AWP 24 AVL 22 ECM 20 BYS 19 CWL 18 DRY-BEV 16 BCS-CQK-DJJ 14 AMA 11 AG 10 AZI-YH-CDC 9 BRG-DRD-CSK 8 ECY-BUX 7 CAM-DET-AVM 6 DLN-DZX-DVL-BAZ-APR 5 EEJ 4 AUP-AFC 3 CHU-EAW 2 AAN 1.

#### PACIFIC DIVISION

NEVADA—SCM, Keston L. Ramsey, W6EAD—New ORS: W6HGL and GYX. W6UO is building P.P. '52s final. W6AJJ is building new rig for NCR. W6BYR has 212D modulator. W6BIC is experimenting with antenna coupling ideas. Active at Elko: W6FKY, HGU and

IEN, W6KBZ and EAD are building new rigs. New Reno hams: W6JYA, KGS, JVH. W6GGO is operating at Moapa C.C.C. camp. W6EEF is operating again. W6BIG is on 3.9 mc. 'phone. W6HHY is on 1.7 mc. 'phone. W6DSD moved to Hawthorne. W6INT has new receiver. W6FUO built a condenser mike.

Traffic: W6GYX 145 HGL 138 UO 47 AJP 43.

LOS ANGELES—SCM, Francis C. Martin, W6AAN (W6BPU pinch hitting). Seven stations make BPL: W6AZU, ETJ, CIL, ETL, BSV, GNM, GXM. Quarterly A.R.R.L. Banquet, under auspices of Federation of Radio Clubs, put over by Pasadena Club with 560 in attendance. A.A.R.S. "get-together" at Arcadia attracted 27 members from southern California. New Clubs: At San Pedro, W6CWK president. At Atascadero, W6HOP president. Whittier Club sends in first traffic report. New reporters: W6BKG, BPR, CRY, DHK, ETI, FAP, GHI, GRT, GXZ, HAT, HBF, HJR, HWM, IDU, IHU, IOX, IS, JXZ, KBD, KEI, KEJ. Report but no traffic: W6BGF, CDM, DHG, DZI, EBJ, EGC, FDM, GKE, IJO, INC, JAC, JOE. New appointments: ORS—W6AZU, DYQ. Reinstated: W6LNF, OF. New rigs: W6AHP, FXR, FYT, IIK, IOX, LN. Rebuilding: W6CEM, FMO, HXU, INC, IRD, JGU, JZE. New receivers: W6AIF, AZP, COF, DEP, DJS, JXZ. New QRA: W6RZF, DQZ, GNZ. New antennas: W6BFL, CVV, GG. DX: W6AM works all continents this month on 7 mc. about 9 p.m. W6FTT says 14 mc. fine. W6BYZ heard by VK7, VK2 and ZL on 3.5 mc. RM Net: works daily on 3605 kc., W6BPU, EDW, FGT, FTV, GNM, ZX. W6GXM has ten daily schedules and can furnish two hour service to W1MK. Second op of W6CXW on way home from Japan. W6BNO, TN say no more rebuilding for them. The 56 mc. gang on every night at San Pedro for rag chews. W6KBY reports for Hollywood gang and ERT for San Pedro. Code Class: W6CJT, 1888 kc., Fridays 7:30-8:30 p.m. W6DOX studying for broadcast exam. W6FYW, IRD join A.A.R.S. W6ILV helps gather traffic reports. W6FJK handles traffic with 6 watters input. Edw. Obenchain, Hawthorne, received a Commercial First Ticket before his first QSO as a ham. He is old Navy man. Wish the gang would let us know how they like this new way of reporting.

Traffic: W6GXM 1840 ETL 1131 CUU 436 GNM 417 AZU 402 ERTJ 370 CII 291 BPU 204 ERT 171 AKW 169 FYT 162 BSV 155 BVF 124 FTV 120 DEP 91 AIF 90 LN 81 GTE 66 DQZ 65 HEW 61 AAN 53 PGT 49 JZV 47 BPP 45 EGJ 43 DYQ 42 EQW 41 DRQ 40 GFG 38 AM 36 DNA 35 DJC-DJS 32 FWN 25 DYJ-IXH 24 IRD 23 JWL-GZC 21 KBY-DUC-COF-BPM 20 GRT 19 HXU-CAH 18 GXW-CBM-DWP 17 AHP 16 EUV-ETI-HFG-FEW 14 DCJ-TN-JGU 13 DVV-CXW 12 FCE 16 BMN-KEY 11 DRL-HOP-IOX-GMA-HZJ-GLZ-CQG-FEX-LC 10 ANN-CNO-FIT-FFN-BFL 9 CLY-IK-WT-HAT-GHZ-FOZ-IBS 8 DHK-CLK-FAP-KEI-GWO-FMO 7 HBF-GNZ 6 BNO-HDC-DOP-CRY-KBD-BKY 5 CPM-DYH-HOB-HJW-MA-GHI 4 HJR-SJ-EXQ-PXF-JXZ-AJR-FJK-DUX-AXQ-HZM-HHG 3 GG-KFA-CVV-DOK-AEM-JNE-PD-AAE-IS-FJS-HWM-GXZ-FXL-DZR-BVZ 2 FYW-AGF-BQF-IDW-FXR-VO-IHU-GZQ-JGL-JOJ 1.

SANTA CLARA VALLEY—Acting SCM, Barton Wood, W6DBB—W6FBW and YG send FB totals consistently. W6YL and HJT report by radio. W6GR visited L.A. W6AUC moved to Hollister. W6HJF worked all Ws and 24 states. W6AOF, 1.7 mc., is new OPS. W6DBB is taking portable to Arizona. Antenna at W6BSO blew down twice. W6HCC worked VS6AE. W6BMW is QRL C.W.S. and C.C.C. W6HJT keeps tubes warm at YU. W6BCF has license trouble. W6FUM has new MOPA. W6JYV has new receiver. W6LF is going class B. W6BBP will modulate the 211D. W6GKY is c.c. with '46s final, modulated by pair of '50s. W6HZW was given a surprise birthday party by local hams.

Traffic: W6YG 172 FBW 67 YX 43 YL 3R Q2 ACU 22 HJF 9 GOZ 8 AOF-FDB 6 BSO 3 HCQ 2.

EAST BAY—SCM, P. W. Dann, W6ZX—The new SCM wishes to express his thanks to the fellows on his election. Chief RM W6RJ moved to 230 Mather St., Oakland. New ORS: W6JTV, AKB, ALK. W6CIZ is

moving. W6CDA is still under the weather. W6CKG was laid up with FLU. Received cards from Moscow: W6GHD and TG. New Barret super and installation of Universal Antenna Coupling system per W9CXX by W6FAC. Experiments with remote control and break in by OPS. W6CGU. New job: W6FS. Oakland Radio Club elected officers. W6IUF is active on 'phone assisted by old friend W6EDR, the "Golden Voice" of Berkeley. W6ZX has nightly schedule with the RMs of Los Angeles Section on 3609 kc. W6GXM, L.A., wants schedule with reliable station in Oakland, Berkeley or SF for NOON.

Traffic: W6GHD 464 RJ 237 ZX 161 EJA 131 FII 109 FAC 100 TG 54 YM 41 AF 29 CGU 15 FS-DHS 10.

SAN FRANCISCO—SCM, Byron Goodman, W6CAL—W6ZG (ex-W6PQ), W6NK, and RM W6JAL BPL. W6HIR and RH seek ORS. W6SG is active on 1.7 and 28 mc. 'phone. W6ENM is troubled by a BCL with a wire-cutting complex. New ORS: W6DDO. W6JGD at Fort Bragg teaches school. Rebuilding: W6GXV, IPH, KCC, EKQ, HJP. W6WM uses 4 '10s in parallel P.P. in final. W6JMR QSOs W1's with flea power on 3.5 mc. YL W6ATP was vacationing. W6JWD seeks OPS. FBXA FB, says W6DTR. New c.c. rigs for W6GKO, JQZ, JUV, DDO. W6HRY moved QRA. W6HSA is building 1.7 mc. 'phone. W6JBY works East coast with Tritet unit only. W6JBZ says DX hard on cards and stamps. New HK354s for W6MV's final. W6CIS uses link coupling throughout. W6FAJ handled a death message. QRO plans at W6AVX. W6JPA enjoys 3-way QSOs with JMR and JDG. W6JQJ alternates between 3.5 and 1.7 mc. W6BVL would like to use his commercial ticket. W6BIP schedules England and France. W6AZX wants east coast 14 mc. schedules. W6ABB QSOs ZL on 3.5 mc. According to W6ZF, AZK can't take it. W6CAL bemoans the fate of 28 mc. W6ZS is priming for DX tests. W6BTZ is QRL school. Thanks for the big month, men, 39 reporters, the best yet!

Traffic: W6ZG 1484 JAL 295 NK 202 HIR 136 RH 51 SG 33 ENM-DDO 29 JDG 28 GXV 20 WM 18 JMR 17 ATP 10 JWD 9 DTR 7 GKO-HRY 5 HSA-EKQ-JYB-JBZ 4 MV-IPH-CIS 3 FAJ-AVX-KCC-JPA-JQJ-JVU 2 BVL-HJP-BIP-AZX-CAL-ABB-JQZ-AZK-ZF 1.

SACRAMENTO VALLEY—SCM, George L. Woodington, W6DVE—W6JVF uses an '01A with a loop as a resonance indicator. W6CEQ has 50 watters P.P. W6CNC is with C.C.C. W6GBB has new call-KFY. W6FOD's crystal won't perk. W6HYM plans more power. W6DZW is on regularly. W6EEB takes life easy at Lake Almanor. W6GZY is thinking of joining Army net. W6HLQ has trouble with r.a.c. W6NT is adding a pair of '46s. Ex 6EMX is now W6KKB. W6GVM is rebuilding everything. W6KCA is joining Navy. W6PI is on 1.7 mc. 'phone. W6BYB is c.c. now. W6GDJ is going c.c. W6FLR is going to Junior College. W6YS lost his antenna. W6IZE worked his brother in Nebraska on 7 mc. W6GR is playing with 28 mc. W6PFP is on 1.7 mc. 'phone. W6DVE has new MOPA. W6CQM is new traffic reporter. W6GAC, our new Route Manager, would like to know how the gang would like some kind of a section contest with a good prize as the incentive. Drop us a line, fellows. New calls: W6JOR, KBO.

Traffic: W6CGJ 124 HEP 109 DVD 34 GAC 33 KBK 15 CQM 11 DVE 9 DYF 5 GZY 4 DFT 1.

ARIZONA—SCM, Ernesto Mendoza, W6C-W6BJF—W6ALU and HEU BPL on deliveries. W6HEU was Arizona high for 8th C.A. A.A.R.S. contest. W6BLP likes 4th harmonic 7 mc. zepp. W6GZU has 50 watts input to '10 final. W6JHF put in c.c. W6HKX uses 1.7 mc. 'phone and 7 mc. C.W. W6CQF is vice-pres. of "CQ Club" for all calls having CQ in 'em! W6DOW rebuilt portable. W6IQY worked PY, J and KA. W6GFK uses flea-power portable. W6CKW is QRL C.W.A. W6HQJ is building c.c. job. W6ILL schedules W6IIF. New calls: W6KBJ, JHV, JKS, JUC, HRH. W6FBE was W8ZZM at Detroit. W6BQW has tritet. W6FGG wants OPS. W4CCM and W4ANI are now W6KGG and W6KGL. W6DVJ started "Ace Radio Service," at Phoenix. W6JYQ hunts DX. W6IUY finds her schedule with KFC makes the OM, DSQ, faster on the code! W6FKX has prettiest rig in Phoenix. W6FZQ has new 830 in final. W6DCQ has 'phone

schedule with California. W6JIL is hunting and trapping. W6EFC sports new Oldsmobile Coupe. W6GGS is building combination phone-CW portable. W6ZZCB is on job. W6HUZ is in partnership with JRK. W6AND builds 1 KW heap for FEA. W6IG made commendable A.A.R.S. score. W6BYD donated a 211 for hamfest prize! W6GHC is seen at club meetings. W6JVR, bedridden, finds amateur radio a blessing. W6GJC has 25 cycle "juice." W6JZQ is corporal in radio section, N.G. W6GBN uses pair of dynamotors for high-power supply out in desert. W6DPS attends Los Angeles radio school, so his dad gets license, KIQ, for schedules!

Traffic: W6ALU 593 HEU 177 BLP 58 GZU 38 JHP 21 DRE 18 HKX 10 CQF 6 DOW 5 BRI 4 IQY 3.

PHILIPPINES—Acting SCM, N. E. Thompson, KA1XA—KA1LG contacts W6CXK on 3.9 mc. 'phone. FB for 100 watter.

Traffic: KA1HR 1368 NA 405 LG 261 CM 139 FS 120 RC 108 CO 107 EE 67 XA 48 CS 40 TS 26. KA4GR 22 KA9WX 100 EP 47.

SAN DIEGO—SCM, Harry Ambler, W6EOP—RMs W6FQU, W6QA. Phone RM W6IBK. W6FWJ, BMC and DQN make BPL. New rigs: W6IBK, BOW, EOP, BMC, LD and KBX. W6EFK hears lots of AC notes. W6FQU has new crystal. W6BEF and CNB have new Transceiver. W6LD moved. W6BHV was on for ORS party. W6EWU is on 'phone. W6IBK worked W9GDC on 1.7 mc. 'phone at 3:30 p.m. W6BAM was heard in Germany. W6EEK won radio club DX contest. W6JGG is ex-6CEZ. W6FKT will soon be on 'phone. The San Diego Radio Club will hold a hamfest soon. Fallbrook has 8 active club members.

Traffic: W6BMC 1000 DQN 612 FWJ 524 EFK 269 FQU 133 AXN 66 BHF 53 BHV 42 EWU 27 IBK 17 BAM 7 DWA 6 BLZ 5 CNK 4 FKT 1.

SAN JOAQUIN VALLEY—SCM, G. H. Lavender, W6DZN—W6CXK, ex W6BHQ, again makes BPL by schedule with KALIG. W6FFU sends code practice every Wednesday on 1790 kcs., 7 to 7:30 PST. W6AME is taking portable on vacation. W6EXH is new Alt. NCS. A.A.R.S. W6AGV is using antenna coupling system per Feb. QST. W6CVL has developed a new c.c. circuit. W6ENH dropped to low power. W6DXG is at Camp No. 27 Gen. Grant Nat. Park. W6GJJ is all set for DX Contest. W6CQI uses both 'phone and c.w. W6DQV is QRL Army and Navy drills. W6IKG has two new transmitters. W6GQZ is going 1.7 mc. 'phone. W6GXL and CLP work plenty DX. W6AOZ is glad to get back to Sunny California. W6FFP wants to know how in heck to go about making a hamfest an A.R.R.L. Section affair. Among notables present at Merced Hamfest were S. G. Culver, Director of Pacific Division and Mr. Sargent, builder Sargent receivers. W6FPW, ex W6AHO, is working hard on coming Division Convention.

Traffic: W6FFP 375 CXK 240 EXH 112 FFU 103 AME 97 FPW 60 AGV-GJJ 58 ENH 53 DXG 50 CQI 38 DQV 26 IKG 21 CLP 11 GQZ 10.

#### ROANOKE DIVISION

NORTH CAROLINA—SCM, G. H. Wright, Jr., W4AVT—North Carolina has two 'phone nets operating very efficiently. 3.9 mc. net with all stations on 3910 kc. operates Sunday mornings at 10:00 o'clock. W4PW is master of ceremonies. 1.7 mc. net operating at 9:00 o'clock Sunday mornings, frequency of 1995 kc., W4BHR is master of ceremonies. With deepest regret we report the death of Mr. J. M. Crump, W4ZN, of Winston-Salem, N. C. recently in Washington, D. C. W4AIS hears plenty of "J's" on 7 mc. W4UB blew a '10. W4CB (ex-W2BBG) is now in Burgaw. W4BTC gets out FB. W4CJP is president of new Burlington club. W4BVD has new power supply. W4ALK and CGH send nice traffic reports. W4HV is turning his interest toward Television and PA's. W4AHH worked a W6 on 1.7 mc. W4RE wants N calls for NCE. W4DQ has new QRA and new OW. W4DW and ABT attended Roanoke Hamfest. W4JB and ANU are active on 3.9 mc. 'phone. W4ATC, State College Club, is building new receiver. W4BRT uses 3.5 and 7 mc. W4BHR and TP are building new 1.7 mc. 'phones. W4CNV is on again. W4ANZ has license renewal

trouble. W4BXB is moving to new QRA. W4CPU is a new Charlotte ham. W4OG has rig working FB. W4BYA wins banner for being most active ham in Winston-Salem. W4BXX is putting in 3.9 mc. 'phone. DX hounds: W4IF, BV, MR, BDU, CQC. QRL: W4BHP, EC, CFR. W4IY added an 830. W4RIU was injured fighting fire. W4RA is getting set for DX contest. W4AAHF got commercial 'phone ticket. W4NC reports interest picking up in Winston-Salem club. W4ABT (???). W4SB just married. W4BZJ has plenty of fun on 56 mc. W4COK has new FB-V-8, W8JXZ, of New York, is now located in Winston-Salem, on 3.9 mc. 'phone. W4AMC has new Cross 20W Jr. W4BRK was not allowed to inspect Radio equipment on the Schooner Seth Parker while docked in Wilmington harbor. R. I. states that he has not had a single report of off frequency from North Carolina this year. New receivers: W4ATS, ZH (Comet Pro's), W4TJ (FB7A), W4BFB (Patterson).

Traffic: W4ALK 186 BRK 161 EG 155 DW 132 BTC 115 CGH 109 AVT 97 AIS 76 BST 70 CJP 53 ZH 41 UB 32 IF 31 VW 26 BJV 25 ANU 20 AOA 18 RX-BX-BLU 16 BDU 15 BJZ 14 OG 13 PW-CCH-EC 12 NC-BHR-BRT 11 ART-BLN 10 AMC-AHH-CS 8 BHP-BZF-BV-RE 7 CB 6 CAY 5 TJ-BVA 4 CJU-TP-NY-JB-HV-MR-AEH 3 RA-BYA-ALD-BVD 2 BUE-ATS-BML-CGY-CCF-IY-BXX-CFR 1. W8JXZ 1.

VIRGINIA—SCM, R. N. Eubank, W3AAJ—Chief RM W3GE, Fone RM W3GY—Emergency work: W3EBB. Important traffic: W3EBB, CMJ, EGW, EAP, BSY, AHC, CWS, UVA. New reporters: W3AII, APF, CA, CZX, EAP, ECQ, JG, AHC, AGY, AZU, BAG, BEB, BRA, BSM, BTM, BTR, CAH, DDA, EBB, EBK, FE, WM, BIW, BKJ, BRE, BUR, EBV, GE, UVA. New calls in state: W3EEN, EYJ, DDA, EKG. Rebuilding: W3CVQ, ECR, CAH, CZJ, DDD, EBD, EBK, DFW, MQ, AKN, DZW, NO, DZH, CAK. New transmitters: W3AAJ, AII, AEW, ECQ, EAP, BUR, CNX, BSY, DDA, VZ, AZU, BSB, BPA, SKCB. New receivers: W3DAM, VZ. New antenna: W3EBK. Want schedules: W3APU, BPA, CMJ, CM, EBB, IZZC, GE, AAJ, BAD, CMJ, DNR, BJX. QRL: W3DES, EGO, BPI, BWA, BPA. Sickness: W3DWW. W3TM was killed in plane crash. W3UVA lost his grandmother. 3.9 mc. 'phones: W3GY, AEI, CNY, ZA, AVL, AHQ, BSY, CZJ, BIW, AZU, BIG, CLJ, EGU, AVR. Nets in Virginia: Railroad QRR by W3CA Sunday 9 a.m.; A.A.R.S. Monday nights 6 p.m. 3770-3800 kc. by W3FJ; OPS 3.9 mc. Sundays 8:45 a.m. by W3GY; 1.7-mc. 'phone net by W3AHC; Va. Net 3.5 mc. 2 to 2 p.m. Sundays by W3FJ and W3AAJ. Beginners helps: W3AKN—Code Class M., W., Fri. nights; W3AET—Code class; W3DDY Code class. Rag chasers: W3BZ, CYU, DWE, EHL, IZZC, BTM, CFV, CSI, AEI, ECQ, EGW, APF, CNY, DEH, TJ, ALF, EGU, BUY, DNR, DQB, BSW, BRY, DDG, AZU, BSB, DRK, CIJ, BAG, BDZ, CDW, DAM, BNH, AHQ, ASK, CYM, EBV, BSM, BZE, FE, APT. DX stations: W3BTR, EBB, CMJ, IZZC, AII, BEB, BAD, CZX, GY, BAI, ECQ, DQD, CNY, DEH, EAP, ALF, BAG, DAM, BAN, AG, BSY, BGS, CZJ, DDD, BKJ, APT, BRE, CWS, BYA, CLJ, UVA. Experimenters: W3RIW, BRE, DXO, DWE, EHL, CZX, AEW, GY, BAI, AAF, EGW, EGU, APF, BUY, BXX, DEH, EAP, AGY, DDD, EBK, BSM, BKJ. Added crystal control: W3ECQ DDD, CWS, DXO, BSB, SKCB. Hamfests—Club news: 70 at Roanoke Hamfest Feb. 18. W3AEI is working on club. Peninsula Club has FB rig. W3ADD is planning Norfolk Hamfest. U. of Va. club is ready for April 15th Floating Club meet. Danville wants N.C.-Va. Hamfest soon. 1.7-mc. 'phones: W3BEB, BTM, APF, CDW, AHC, CAK, BIW, DDG, DXO, AIJ, DVP, CAK. SCM's monthly message: Division Convention Roanoke Fall. Kindly send QRAs of new hams so I can send bulletins. Congrats to you for breaking all records last month. 73. Special mention: W3GY won OPS contest. W3BPA schedules Byrd. W3EBB handled traffic about an S.O.S. from W9OSQ. Miscellaneous: W3EHL operated at Scout exhibit as did W3EBD. Class A Ticket: W3APP, AII. Ten best traffic stations: W3APT, EBB, CMJ, NT, IZZC, BPA, BYA, AAJ, CA, DCU. W3CYV

QRA: D. C. Chess match: W3BSY, 3FJ, W3GY schedules W1SZ Sats. W3DGH QRA: Kingsport, Tenn. W3BAI will fly mail. W3EAP is ex-3IU-'19. W3BAG QRA: Richmond. W3BAN was best OO for 1933. W3AG worked 80 countries. W3ASK was QSO London both 5/8 3939 'phone. W3BWA is on 3700 kc. W3COO: Clarksville. W3EBV is ex-8DMC, 9AHA, 9FVK. W3FJ is also WLQD 3497.5 kc. W3NT is on 3700 kc. W3CVF is back home. W3WM sends lots dope. W3AHC contacts 85% of calls—(Including reports received on 21st).

Traffic: W3APT 258 EBB 247 CMJ 196 NT 163 BPA 110 AAJ 103 BYA 73 CA 71 DCU 66 FJ 48 AHQ 41 AII 47 AHC 35 CEY 28 BEB-BSY 26 DDG 25 BAD 24 BTM-CFV 22 EGD 21 CSI-EBV 20 EBD 18 CZX-UVA 17 AEW-AG-BNH 16 GY 15 AEI 14 BAI-ECQ 11 DQD-WM 10 AAF-BGS-GE 9 AGY-APU-ASK-EGW 8 APF-BIW-CZJ 7 CNY-DEH-TJ 6 BIG-BRY-CWS 5 ADD-BAN-BSB-BSM-BZE-DDY-EBK-EAP 4 ALF-BAG-BRE-FE 3 BDZ-BUR-CIJ-CYM 2 BKJ-BWA-CDW-DAM-JG-EGU-DVP 1 BUX 62 DNR 31 DQB 19 CXM 59 BKN-OM 2. W1ZZC 145. W8KCB 2.

WEST VIRGINIA—SCM, C. S. Hoffmann, Jr., W8HD-WLHF—The W. Va. Net continues its daily 6:30 p.m. schedules. W8GB and KKG are new Net stations. W8IKN handled W. U. traffic during storm which blew down wires outside Elkins, sending their traffic to WLH, A.A.R.S. in Columbus, Ohio who put it on Western Union circuits there. Fine work, Robinson. WLHG (W8EIK) is taking WLH's (W8ZG) place as Corps Area NCS A.A.R.S., while WLH acts as NCS of the Army (in WLM's place). U.S.N.R. appointments: W8ADI, Commanding Officer, 3rd Sect., 5th Dist. (W. Va.); W8ELO, Commanding Officer, Unit 3, 3rd Sect., 5th Dist. W8AKZ and CIJ join U. S. Forest Service. W8TI arranges 28-mc. tests with AC2BHH. W8BAD and GBF consolidated. W8GAL and BDP use 830s. W8GEG and ETX married! W8ESQ, BOK, AMX, ILY and HSA are on 1.75-mc. 'phone. W8KXB, KXC, KWV, KGT: rebuilding. W8AMX operates Clarkburg Police Station. W8ASI and BOK are on 56 mc. W8ILK and GSN: new Keyser stations. W8FQB wants schedules. Mountaineer Radio Club (Fairmont) held first banquet in Clarkburg, Feb. 4th; second banquet in Grafton, March 4th. A banquet and hamfest is being arranged to be held sometime during June, in Fairmont. Everyone invited; write W8JM for info. New Moundsville stations: W8KSS, LBI, LES. W8JKG, KKG apply for ORS. Our sympathy to W8HCL, whose Mother died. W8HWT has s.s. receiver. W8GB and HUK are new A.A.R.S. W8KSJ has '800 P.P. job. W8JZU will increase power. W8KWU says "a check on your frequency a day keeps the RI away!" W8KDP applies to joint W. Va. Net. Applications for membership in W. Va. Net may be sent to the SCM or to W8EIK; all stations must be A.A.R.S. W8JKN (ex-8LJ) is active at Buckhannon. W8DPO worked Finland. W8ELJ has oscillator trouble. W8EWM attended Winston-Salem Hamfest. W8DFC uses c.c. rig. W8AHF is W. Va.'s first Official Phone Station! New ORS: W8HCL, GB (re-appointed); BDD, KWU.

Traffic: W8GB 202 BDD 132 ELJ 125 HD 104 EIK 87 OK 82 TI 39 KKG 30 JM 29 JWL 26 AHF 14 KDP 16 DMF 12 BOW 8 HBQ 5 ELO 2 GAD 7 BOK 5 DPO 20 KSJ 4 KWU 26.

#### ROCKY MOUNTAIN DIVISION

UTAH-WYOMING—Acting SCM, Arty W. Clark, W6GQC—The "ROCKY MOUNTAIN WYMU" is bulletin for active hams of Utah-Wyo. Your copy sent on receipt of your report. The MURRAY AMATEUR RADIO SOCIETY was organized with W6AMD pres., W6ITW vice-pres., W6FPJ, Lee Aamodt, 279 E. 45 So., Murray, Utah, secy-treas. Other charter members: W6GQU, W6HHV, Spencer Ohlin and Dale Collins. Meetings held at W6FPJ shack. W6DEM got his first ZL. W6FAE is at Fort Douglas Radio WYX. W6DPJ and DTB are enjoying foreign DX. W6GQR sticks to schedules. W6DGR is ready to resume schedules. W6BLE is experimenting with modulation indicator and cathode ray tube. W6DKB is on 3.9 mc. 'phone. W6BAE demonstrated

Univ. Ant. Coupler at U.A.R.C. W7COH heads Wyo. traffic net with W7AMU, ABO, AXG, CSE on circuit. W7HX, SNCS, reports 100 per cent station activity in A.A.R.S. W7AOU fears 'transfer. W7CLG renewed A.R.R.L. membership. Active: W7OCC, CRP, CPL, 175 mc. 'phone; W7ARK, BJS, 3.9 mc. 'phone; W7AXG, ASX, 3.5 mc. CW. W6KGM, KDE, KEJ: new stations, S.L.C.

Traffic: W6GQC 827 DPJ 314 FYR 276 EXL 200 AHD 59 FAE 46 JVA 44 DKB 8 GQR-AFN 5 FRN-BLE 4 DEM-HTN 3 IWY-ITW-DGR-BAE 2. W7COH 127 AEC 68 CSE 45 AOU 38.

COLORADO—SCM, T. R. Becker, W9BTO—W9ESA still is the leader in traffic. W9CJJ needs 50 watt sockets. W9BTO and HQT have Pettersons. W9FYY ran a new power line in for his transmitter. W9BYK has FB7. W9AAB will swap his field glasses. W9BYY cased a rack from BTO. W9DDF rides the Police Patrol cars. W9HIR may move to Boulder. W9GVN has Graphite plate '10. W9BJN is going to grind crystals. W9CND is QRL work. W9LNB has condenser mike. W9JB and AUJ are employed again. W9GHL teaches school. W9BCW invites you to join U.S.N.R. W9GBQ has an FBXA. W9EKQ holds up the A.A.R.S. W9YL has new 'phone. The P.P.A.R.A. and The Greeley Radio Club staged a debate on the subject "Resolved that Amateur Radio Stations of all Classes should be Limited to an Input of 100 Watts to the Final Stage." The P.P.A.R.A. had the negative side of the question and won the debate with a vote of 3 to 0. W9KNZ is doing well at Woodmen. W9KCC is on 3.5 mc. c.w. W9GNK keeps regular schedules. W9GJQ makes the BPL FB. It is with deep regret that we note the passing of one of our members, W9IUI, who was murdered in Los Angeles while going to the aid of a woman secretary in the offices of KEJ. W9BRZ is working on MOPA. W6ERC is reported located in Grand Junction. W9GLI has trouble with 'phone. W9LQO, the YL, is active. W9MDN has new c.c. rig. W9NPP blew his filter. W9OYE has SW3. W9MLU is teaching a CWA class in radio. The two YL ops at MDN and LQO are working for Class "A" tickets. W9CDE says traffic can only be handled by reliable traffic routes and schedules. Rebuilding: W9FYK, ECV, IES.

Traffic: W9CDE 56 ESA 1060 GJQ 762 GNK 254 EHC 3.

#### SOUTHEASTERN DIVISION

ALABAMA—SCM, L. D. Elwell, W4KP—W4BOU leads with big total. Several Alabama hams met in QSO Party Feb. 18. We hope to have a party each month. The A.A.R.S. Phone Net led by W4RS is going on a single frequency. W4AG is new O.O. for Alabama. W4AAQ will have rig in Mobile before long. W4COU requests ORS. Don't forget Oct. 19-20 for the next Convention. W4CRF and NU report with Mobile gang. W4CHEJ puts out an FB signal. W4CJZ worked Seattle, Wash. on 1.7 mc. 'phone. W4BSQ is back on the air. W4BSL says c.w. is best. W4BJA has a few schedules. W4AYK switched from EE to Pre-Med. at U. of A. W4BZG tried 'phone. W4SN made a fine try at QSO party. W4GL wants the next party to include the 7 mc. boys. W4LT is QRL work. W4ASM is a member of the Crack Phone net. W4AIH uses a pair of '26s. W4BCU is back on Phone net. W4BEY is new Anniston ham. W4BTU works plenty of DX. W4CIU swapped his fifty for a pair of '10s. W4AUP uses c.c. W4CJG joined A.A.R.S. W4DS, the RM, is compiling a list of active Alabama hams. W4BMM is the first OPS in Alabama. W4BDH is married. A fine report from W4TC, Anniston. W4BGO reports from Storm Lake, Iowa. W4CCP's gang includes W4CPE, COA and CLQ. Ex-W4PFU is W9PQG in Joliet, Ill. W4CNU and CQO are new Jasper hams. W4OA is busy making records, etc. W4BBO has c.c. on A.A.R.S. 'phone freq. Birmingham Club will have transmitter soon with W4AJP as trustee. W4BMF is joining 'phone gang.

Traffic: W4BOU 834 APU 215 CHJ 140 DS 112 CCP 92 BJA 81 CJG 36 AG 20 GL 17 CIQ 15 AIH-BMM 12 BZG 7 ASM 6 CDT-GA 4 CRF 2 KP 21 COU 3.

EASTERN FLORIDA—SCM, Ray Atkinson, W4NN

—The Tampa gang did splendid work with W4CI at the South Florida Fair: See the traffic table. W4BOX loaned his transmitter for W4CI. W4ALP blew filter at Fair. W4BN and CEO threaten a comeback. W4AFV is back on c.w. The following were active with Fair traffic: W4BOT, BNR, AKJ, AMV, AJX, ALP, CI and PT. W4AXP wants schedules to South Fla. W4COV reports DX FB. W4QF/PFT is now O4AAA, Lima, Peru. W4AXY is on 1.7 mc. 'phone. W4BGL handled traffic from Byrd Expedition. W4CJR has P.P. '03A final. Visiting portables are W2CIF, W9ETD and W9EVO. W4CON and BFR have new c.c. rigs. W4WS (RM) would like to hear from stations interested in Florida traffic. W4NN is handling long hop traffic on 14 mc. W4AGB has turned florist. W4AZB (00) is sporting new '49. W4UX pounds brass aboard a passenger. W4COB is on 14 mc. W4AYX has YL-itis.

Traffic: W4CI 2543 AJX 264 ALP 249 NN 229 AKJ 228 BGL 130 WS 122 BNR 108 PT 40 AGB 32 BFR 15 AMV 12 HY 10 BOT-COV 4 CGV 2 TK 10.

WESTERN FLORIDA—SCM, Eddie Collins, W4MS-RMs W4ACB, W4AUW. The Hamfest at Marianna was a great success and the Marianna gang deserve a lot of credit. W4CRU has complete Gross station. New Pensacola hams: W4CSL, CSQ, CQP, CSR. W4CMJ is awaiting warmer weather for 56 mc. airplane tests. W4CDE has FB super-het. W4QR is going trit. W4KB sends a very FB traffic report. W4AGS is getting a '52. W4AUW gets out FB on 1.7 mc. 'phone. W4BOW and CMB are going to consolidate. W4BKD promises 3.9 mc. 'phone. W4BKV is about most consistent station in W. Fla. W4AYC was a welcome guest at Hamfest. W4COG had 17 QSOs and worked 5 countries in on week on air. W4BFD is QRL drug store. W4QU is on 3.5 mc. W4ART moved to Pensy. W4ARV and CQF are on 3.5 mc. W4UW wants schedules with the gang as he is in Texas. W4BGA and MS have their WAC certificates posted. W4CLN keeps things going in Perry. W4RPI attends U. of Fla. W4BSJ revamped his FB7A. W4ACB keeps FNG drill over W4SC. W4AQA is on low-power. W4AXP is constantly improving his station. W4BMJ has been sick with the flu. Congrats to the W4AUW's on arrival of a new son. W4VW and MV were visitors. W4QR won a '59 at Hamfest. W4AQY won a complete transmitter at Hamfest. Don't forget the regular Sunday morning schedules on 3.5 mc.

Traffic: W4KB 42 AXP 2 AUW 23 BSJ 35 CRU 16 AUV 1 QK 4 BGA 16 CQG 7 QU 4 AGS 10 ACB 12 QR 8 BKV 6 BFD 5 MS 18.

GEORGIA-SOUTH CAROLINA-CUBA-ISLE OF PINES-PORTO RICO-VIRGIN ISLANDS—SCM, George A. Love, W4UT—Asst. SCM, Bannie L. Stewart, W4CE—W4AGI at Ft. MacPherson C.C.C. leads the Section! Alabama's loss is Georgia's gain! W4IR and KV are still consistent hi-score stations. W4CQQ, ATZ and CIR are new ORS. W4CE is now OBS. W2FLB at C.C.C. in Awendaw, S. C. gets out FB. New hams: W4CQG, CRV and CPX. W4GB has new rig. CM2OR is new station in Habana. W5DPQ is portable in Atlanta. W4CMA is on day and night. W4BZW had his bad wisdom tooth rectified. Hi! W4AMG gave interesting talk on oscillators at meeting of Augusta Radio Club. W4BW schedules W4SS. W4CBY plans one kw rig. W4IN uses twisted feed line. Flash—W4HT works a K6! His first station out of state! CMSYB reports by radio. W4UT wants Byrd Expedition traffic. W6AMA is visiting in Atlanta. W4BAB is rebuilding. T12BD attends school in Georgia. W4CBY is new fourth district QSL manager. Send him your stamped self-addressed envelopes and get your cards.

Traffic: W4AGI 506 IR 252 KW 225 BAB 218 UT 118 BZW 68 AAY 33 GB 21 CIR 17 CBY 15 BW 14 CE 10 COO 9 AEI-CMA-RM 8 CQQ 2. W2FLB 9 CM8YB 144. W9LMS 10.

#### WEST GULF DIVISION

NORTHERN TEXAS—SCM, Glen E. Talbutt, W5AUL—W5BAY, Phone Activities Manager; W5BII, Chief RM; W5IA, W5ARS, W5BKH, Asst. RMs. Traffic: W5ANU resigned as RM. W5CCP is located at Cleburne C.C.C. Camp. W5AW is holding his own to win

1934 traffic prize. New ORS: W5CPB and CPT. W5AVA and BYM want ORS. W5CHJ joined A.A.R.S. W5BII wants traffic for Byrd Expedition. RMs and the SCM have round table on 1st and 3rd Sundays at 7:30 a.m. You are invited to join us on 3.5 mc. PLEASE send reports in on the 16th, fellows. W5AUL is on 6990 kc. with WLJA daily in 8th C.A. Net. Phone: W5BAY is busy saving the "power trusts." W5SP has a new home. W5AHC is going OPS. W5IT has an MG attached to his auto for emergency power supply. W5APW reports by "special delivery." W5QA and CYU are using "substitute rigs"; practically every part is a substitute for what is called for. Reports from more phones would be appreciated. Brass: W5NW and "OW" W5DUR have 1 kw on 7 mc. W5DKF and AVA have new QRAs. W5CXS blew 8- '47s. W5CMS, DXA, AUJ, DJL, CAM: rebuilding. W5BYV "claims" R9 report from Japan. W5AZB is c.c. Other reporters: W5DVV, AJ, DAA, BTJ, DQW, CPU, CIJ, CPX, ATI, CAV, AQS, BYM, BKC and ARV. Clubs: Wichita Falls Club banquet is April 21st. The Dallas Club had a big banquet Feb. 23rd. The Athens Club applied to A.R.R.L. for affiliation. A.A.R.C. and A.A.A.A. in Abilene plan to attend WFARC banquet en-masse. What are the other clubs doing? A section bulletin is sent free to all reporting stations. Reserve your copy next month by sending in that report.

Traffic: W5BII 351 CIJ 291 CCP 218 AW 149 AUU 140 ANU 128 IA 100 AHC 104 CPX 97 CMS 89 CYU 79 ARS 65 BKH 50 CPB-ATI-CAV 18 AQS 17 CPT-DKF 14 BYM 13 BVF 12 CPU 10 DQW-CHJ 9 CXS 8 BTJ-DA 4 AUJ-DXA 2 AVA 1 CAM 10.

OKLAHOMA—Acting SCM, St. Sgt. R. F. Hinck, W5BQA—This will be my last report. I wish to thank the fellows who have helped me with the work and tried to keep this Section on the map. W5CEZ and BDX have done excellent work. W5CEZ is our new SCM. Congratulations to him on his election. Give him your hearty support. 73 to all.

Traffic: W5CEZ 874 BDX 242 BQZ 143 AKK-BAR 45 GW 18.

SOUTHERN TEXAS—SCM, D. H. Calk, W5BHO—W5OW-W5BEF-W5BWM-W5BB report. . . W5CET's YF gave him a new Bug for Christmas. W5ADZ is building new freq-meter monitor. W5MN keeps several daily schedules in A.A.R.S. W5VV sailed for Bermuda. W5HX worked YH1JP. The Galveston Amateur Radio Club had a nice write-up and two large pictures in local papers. W5DTB is on with '45s. W5BTK is building 50-watt c.c. rig. W5BTK and BEH work with the club on 56 mc. W5AUX and DSI work DX. W5AMC is building new 14-mc. 'phone. W5UX will have 500 watts ready for DX Contest. W5ABQ is building 100-watt 1.7-mc. 'phone. Ex-W5RR is now in Minneapolis, and has new addition to his family. W5BBC also has new addition in family. W5PF works the world with '45s. W5VL operates KMAC. The San Antonio Radio Club publishes a small paper called "Gutter Dope." W5BFA has been appointed OO and OBS. W5CUE moved to Roswell, N. M. W5BHK works out FB on 1.7-mc. 'phone. W5BYF is QRL Politics. W5BGZ is new A.A.R.S. member. W5QX is QRL filling station. W5AYJ is awaiting license modification. W5DWW is new San Angelo ham. New officers of the San Angelo Radio Club: W5BDE, pres.; W5DWW, vice-pres.; Clarence Talafuse, secy.; C. B. Will, treas. W5DLT ordered new receiver. W5DOM and DOV work DX. W5CYO is now at La Porte. W5DPA, Houston Amateur Radio Club, transmits code practice every Monday and Friday nights.

Traffic: W5OW 1680 MN 518 BFA 146 BDH 318 VV 87 BB 14 ADZ 5 BEF 6 HX 3.

NEW MEXICO—SCM, Dan. W. De Lay, W5DUI—Kindly forward your reports to SCM's new address: 407 South Girard Street. W5ZM took traffic honors, making BPL with 100 deliveries. W5CGJ is off sick list by looks of his total. W5DXX is new Roswell ham. W5AOP is new ORS. W5AUQ submitted ORS application. W5BNT is working on trit. W5AAX may move to coast. Frank Hawks visited us a short time while on his way to coast.

He is taking portable with him to China. W5ZM has been appointed Chief Phone R.M. All phone men please get in touch with him.

Traffic: W5ZM 343 CGJ 230 BNT 102 AUQ-AAx 4 DUI 1.

## CANADA

### MARITIME DIVISION

NOVA SCOTIA—SCM, A. M. Crowell, VE1DQ—1DE is reliable eastern end of trans-Canada route. 1FN schedules St. Paul Isl. daily. 1FB schedules 1FN and GD. Active on 1.7 mc.: 1CP, GR, DT, GC, FO. Following get European reports on their 3.5-mc. sigs regularly: 1BB, EB, DC, BV, EA. 1DE is new pres. of M.A.R.A., which meets monthly in N. S. Tech. College. All active stations are asked to report to SCM each month on 16th. 1AG is OPS No. 1 for N. S. and will organize a 'phone net on 3.9 mc. 1DQ and AW are doing local duplex on 14 and 3.9 mc. VORY is getting new MOPA. 1EK gets out well on 7 mc. 1BY returned to 14 mc. Active in B.E.R.U. Tests: 1BV, DQ, EP, ET, EA.

Traffic: VE1DE 75 FN 19 GL 17 FB 8 DQ 7 EA 3.

### ONTARIO DIVISION

ONTARIO—SCM, S. B. Trainer, Jr., VE3GT—Winners of Queen City A.R.C. Contest, in order: CW: 3UU, WK, TD, TX, SG, GR. Phone: NZ, EU, JO, UY. 3EU is awaiting summer. 3UY and PN are QRL radio store. 3VX wants reports on his 7-mc. sigs. Ops at 3XX are DJ (Sandy and Jock), EP, QV, VX and WP. Reporting for first time: 3QP (Ex-W9EOJ), RQ, OI, YP. 3WA worked VK6FO on 7 mc., 6:25 p.m. 3NX was heard in ZL, and 3IH in Finland on 3.5 mc. 3OI, NI, and OO are putting in c.c. 3HF worked VQ4. 3OJ and BU visited MG. 3DD is working DX. 3KC, DU, GC, WM and VD are after DX. Active on 7 and 3.5 mc.: 3HZ, TN, VR, WW, QC, IV, NU, NO. 3DW still keeps TL schedules. 3WX continues as our star traffic station. FB, Bob, 3TM's new moniker: "Lady Killer." 3OF wonders how an s.s. works. 3OE is QRL. 3GA tests 28 mc. 3QH worked W6 with antenna on back fence. 3WE moved to Caledonia. 3HP says bald WX hard on club meetings. 3QK's flea power is heard. 3LL, HF, CF, EZ, VD, NM, LR, OR, UU and TA visited 1B. 3SE has schedules. 9AL and 3RK lectured and 3AU demonstrated before large gathering at U. of T. 3EA blew '81s. New officers WAOO: pres., 3AZ; vice-pres., 3JT; secy.-treas., 3GT. 3MX is rebuilding to higher power MOPA. 3LI is working remote control. 3GO reports AI and WZ new Kingston hams. 3CX is working nice routes. The Orillia gang are going strong. 2CX visited 3JI.

Traffic: VE3QB-UU 2 GR 4 RF 20 SG 84 XK-RQ 1 GT 200 OI 1 CX 52 DW 20 WX 821 BZ 77 WJ 31 RO 30 LA 29 OC 10 OM 18 WA 12 VF 27 TB 2 WK 112 DU 1 IQ-QD 4 VD 8 QK 11 JI 110 JT 18 RK 87 LI 10 GO 140 DJ 19 LV 4 TB 13 NB 1 LZ 38 GI 2 TM 74 MX 5 XO 17 QI 5. VE9AL 23.

### QUEBEC DIVISION

QUEBEC—SCM, John C. Stadler, VE2AP—2EE's new transmitter is working nicely. 2HK is after traffic and DX. 2BB has new c.c. rig. 2DG handled important traffic to Anticosti. 2IA new new antenna. 2AC has trouble with outfit. 2HG worked 4 DX countries. 2IJ sends first traffic report. 2BC has high-power phone. 2II and DD visited SCM. 2AW, CG and AM are rebuilding. 2GA hopes to finish new transmitter. 2BG is ready for 56 mc. 2FE is busy "working." 2BF will be on now that hunting is over. 2EO is QRO. 2DB has gone to c.w. 2FZ will have class B phone on 3.5 mc. 2CU is cramming for his degree. 2EC and HT are on 3.5-mc. phone. 2CA uses new grid modulation system.

Traffic: VE2EE 2 HK 174 BH 58 DG 35 AC 8 LJ 11 CA 16 FE 15 BG 24 CX 106 DR 6 AP 13.

### VANALTA DIVISION

ALBERTA—SCM, C. H. Harris, VS4HM—4DX is on 3.5- and 1.7-mc. 'phone. 4KG is building c.c. rig. 4BZ QSOs coast to coast in one night. 4FG has lots QRN.

4NH is building s.s. Super. 4JI moved to Winnipeg. 4JD joined CFCN staff. 4JK is rebuilding with 50-wattors. 4GD is on 14-mc. 'phone. 4AX is building tritret. VE4AW, GY, LEX, BP, IZ, NC, JX, MG, LX are on regularly. From Lethbridge Club: 4OI on 1.7-mc. 'phone; 4OZ using single '45; 4OG works all W districts; 4JR has '10s; 4AF hooks a W1; 4KL is on mornings. 4OF is moving; 4EO wants DX; Club meets every Saturday night. 4NB moved to Kingman. 4PH gets c.c. reports. 4QX is burning up the ether. 4EA, CX, BV, and FR await 800s. 4HM is on all bands. As retiring SCM I wish all Alberta hams the best of luck, and will look back on my term as one of the bright spots in my amateur activities. Hope to have many QSOs with you all.

Traffic: VE4BZ 45 NB 14 KG 10 PH 3 EO 1 LX 51.

BRITISH COLUMBIA—SCM, R. K. Town, VE5AC—

WANTED—More reports on more traffic on more schedules. 5FG and GS worked J's. 5JF had his milke on when he tangled with H.V. Collingwood gang form club, call 5KC. 5EP goes MOPA. 5AC has new sky wire. 5IM applies for ORS. 5EU and CA are rebuilding. 5FM gets break when power line breaks. 5GF is making snappy c.c. job. Nice report from Kootenays via 5EJ. 5FL snaffles W4 on 1.7-mc. 'phone. 5EJ is QRL building for B.C. Police. First reporters: 5FL, IO, IS, IZ, JI, KP. 5EC has nice total. 5AM reports he is horse de combat (hi).

Traffic: VE5AC 29 AL 12 FG 21 IM 23 HP 93 EC 293 EP 30 EU 14 GS 10 HQ 8 EC 5 CE-JO 4 FM 8 DF 145 JA 42 JL 5 KB 4.

### PRAIRIE DIVISION

MANITOBA—SCM, Reg Strong, VE4G—4NI, ex VE3NI, keeps schedules east and west. 4AC of Brandon was a welcome visitor. 4KX's 14-mc. 'phone was heard in England. 4DK Jr. is FB opr. Rebuilding: 4MW, NW. Active on 'phone: 4GL, DU, KU, MV. New stations: 4QN, QY, RA, RF, RL. Active: 4HP, CD, CI, IP, LE, LT. M.W.E.A. stations are holding advanced code practice lessons.

Traffic: VE4LN 41 NI 26 DK 13 GC 10 KX-OX 3 AE 2.

SASKATCHEWAN—SCM, W. Skaike, VE4EL—The Moose Jaw Club is considering Hamfest for May 24th. 4OD has nice vote. 4OM and OP exercise their crystals frequently. 4IV is installing c.c. 4JU is completing Class B 'phone. 4HG is operating the Tech. rig. 4QJ and 4PN at Whitewood would appreciate a call or report. 4HX expects to have 830s P.P. New Saskatoon hams: 4RE, RC, RI, PW, QF, QZ. 4RI, RB and QZ have P.P. TNTs. 4FD worked all W. districts and VEs on 3.5 mc. in one month. 4JV makes YH QSO. 4MA, MB and LI are on 'phone. 4EM got good sock. 4IM picks out YL for QSO. 4BM is back from Forestry service. 4FA is trying 3.5-mc. c.w. 4BN is searching for 28-mc. band. 4IE is chasing "bugs" on 'phone rig. 4MN is making slick aluminum-shielded receiver. 4MH has trouble with MOPA. 4IE expects 300 watts to final if the tubes say Yes. 4BN is looking for DX at 7:00 a.m. on 14 mc. 4MZ has '46 in the final. 4NE is on 1.7-mc. 'phone daily at 1:00 p.m. 4GR will likely be our new Route Manager. Your SCM appreciates the fine reports this month. 4ND has nice rack and panel job. 4CV finds low voltage and crystal plates not flat no good for constant perking. 4CI and EU are building new rigs. 4GA reports 4IE, NE, FL, CE, PQ, JU, PA, PY mainly new stations. On 3.9-mc. 'phone: 4IG, FY. 4PE is on the air with '71A in Hartley at Saskatoon.

Traffic: VE4MH 90 AI 37 EL 27 GR 25 EJ 19 FA 4 BF 3 GA-PE 2.

## Improving the Freqmeter-Monitor

(Continued from page 38)

value indicated. Otherwise the taps on the coil would have to be shifted in order to hit the band approximately. The improvement in the monitor side of the meter is certainly well worth the time and expense of conversion.





# CORRESPONDENCE

The Publishers of *QST* assume no responsibility for statements made herein by correspondents

## W1XJ Operation

The Physics Laboratories,  
Harvard University,  
Cambridge, Massachusetts

Editor, *QST*:

In the course of our routine Kennelly-Heaviside Layer measurements on the 3490-3495-kc. experimental channel, we have received a number of interference reports from Army-Amateur stations operating on 3496 and 3497 kc. As the Army-Amateur cooperation is of great interest to the A. R. R. L. we wish the Headquarters' staff to be informed promptly of any developments affecting that work. The following comments are therefore intended to present our own side of the interference problem.

In order to uphold the reputation of this laboratory, we originally invested in a considerable amount of expensive apparatus for the sole purpose of maintaining our exact frequency assignment and narrowing our band width to the smallest value consistent with satisfactory experimental operation. The experimental data already obtained are of decided value and interest to physicists and to radio men in general. At some future date we hope to present a short description of the apparatus and results in *QST*. Although similar experiments are being carried on by a number of government and university laboratories we believe that W1XJ is the only Kennelly-Heaviside station which signs its call letters at regular and frequent intervals. Our own monitor tests indicate that a modern receiving set may be operated on any part of the regular 80-meter band without serious interference even though the receiving point be only 3000 feet from our transmitting antenna.

However, from a technical standpoint it appears quite unreasonable to expect that an entire network of code stations can operate without major interference on frequencies which are 5000 cycles or less from the center of an experimental channel. Our current issue of the "Rules and Regulations of the Federal Radio Commission" does not indicate any such assignment. In fact it appears obvious that the region 3495-3500 kc. was purposely left open as a guard zone, designed to protect the very narrow experimental channel and the amateur band from mutual interference. The other Army-Amateur channel on 6990 kc. is explicitly designated as a

government frequency. Other government channels in the 80-meter range would appear to be available for Army-Amateur use. Under the circumstances it appears that the interference results from a somewhat unfortunate selection of one of the Army-Amateur frequencies. Satisfactory operation obtained in the past can be explained only by assuming that the 3490-3495-kc. experimental channel has not been in active use, and that no experimental stations have registered interference complaints.

As a temporary expedient we have voluntarily agreed to interrupt our experimental work for twenty-five minutes on Monday evenings, until more satisfactory permanent arrangements can be made. It happens that I am especially interested in the Army-Amateur cooperation, as I have been a member of the A.R.R.L. for a long period, and have also attended the Signal Corps Reserve Officers' camp at Camp Vail in former years when time permitted.

—Harry Rowe Mimo, Asst. Professor of Physics  
and Communication Engineering

## C.W. in the 'Phone Band

Quitman, Ga.

Editor, *QST*:

I have two transmitters, one a moderate-powered 'phone on 160 meters and the other a low-powered c.w. rig on 80 meters. Now and then I move up just inside the 75-meter 'phone band to call a 75-meter 'phone in order to have a duplex QSO on between 160 meters and 75 meters. Occasionally a 75-meter 'phone will come back to me and give me to understand that I am out of my bounds. On two occasions the hams were really sarcastic about it. I have found, however, that the ones that get nasty are those with extreme low power, and mostly those that can't read code to the extent of having a QSO.

I never operate in the 'phone band long enough to cause any interference to amount to anything because when I get my station I tell him to listen for me on 160 meters for a duplex QSO, and that is all there is to it.

There are a bunch of good fellows that really like to QSO with c.w. stations but then, on the other hand, there are some that seem to think the air is theirs and a c.w. ham is not supposed to have any privilege whatsoever. . . .

—S. W. Carter, W4BQT



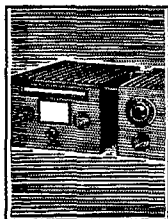

In the thousands of letters which amateurs have written for technical advice, certain problems appear again and again. We feel that some of these matters are of sufficiently general interest to warrant discussing on this page. This month we shall limit ourselves to the FB receivers and the new preselector.

Regarding the preselector, our first suggestion is not to buy both band-spread and general coverage coils. It is an unnecessary expense, for general coverage coils handle satisfactorily in the preselector, even when band-spread coils are used in the receiver. This, of course, is because the unit is much less critical to tune than a multi-stage receiver. Also, since it is ganged to the receiver tuning control, there are no tracking problems. However, we do manufacture band-spread coils for the preselector and if operation is only in the amateur bands, they should be selected.

In some amateur stations, where the power is more than 100 watts, an excessive R. F. signal may reach the receiver, due to the location of the receiving antenna, the location of the receiver, or other causes. In extreme cases, the voltage developed across the input circuit may be sufficient to cause insulation break down and damage to the detector tube, the cathode resistor, and the by-pass condensers. In any case, the tube life is likely to be shortened and the oscillator or detector temporarily blocked after each transmission. A very simple cure is to connect a small neon light between the receiver antenna and ground at the point where the leads enter the metal cabinet. (It may be necessary to disconnect the resistance unit located in the base of some types of neon lamps.) This lamp normally offers a very high impedance which does not interfere with reception, but during transmission it will ionize and by-pass excessive R. F., if any. Try it!

Many amateurs who use homemade power supplies with their FB-7 find that the receiver is very erratic. For instance, there is sometimes no signal when the receiver is turned on. These troubles are due to low heater voltage on the tubes. To be specific, there is a drop of .3 volts in the power cable when carrying the  $9\frac{1}{2}$  amperes required, consequently the filament transformer must supply 2.8 volts under full load. This is really quite important; fifty percent of the cases where trouble has been reported with FB receivers, has been traced to low heater voltage.

While we are on the subject, there is one other important source of trouble—unsuitable tubes. This is a very delicate matter for us to advise on, because many of the makes of tubes that are wholly unsatisfactory in the FB circuit are excellent tubes in the broadcast receivers for which they are intended, and we do not wish to criticize them. We will put it this way: National receivers happen to have been designed around, and tested with, RCA tubes. Consequently, we can vouch for the performance of our receivers only when used with RCA tubes.

JAMES MILLEN · □



# APRIL SALE AND WE ARE NOT FOOLING WHEN WE SAY THAT THESE ARE THE BEST BUYS IN HAM RADIO

## The "EAGLE" Three-Tube Short Wave Receiver

"Band Spread" over any portion of the tuning range — only finest material used thru out. Employs one '32 R.F., one '32 detector and one '33 Pentode Audio — 15 to 200 meters — four coils supplied. The "EAGLE" is economical — two dry cells will operate the filaments. See March or April QST for full description of this most excellent value in short wave receivers.

"Eagle" completely wired and tested... **\$11.95** Three tubes tested in your receiver... **\$3.00**

*A pair of 2000 ohm featherweight phones included in the price for this month only*

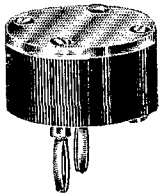
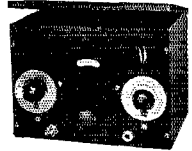

### GROSS CRYSTAL HOLDER ONLY \$1.00

A commercial type crystal holder for half the price you have to pay for ordinary holders. New type pressure spring, square inside to prevent movement of crystal, one piece molded body — dustproof — will take crystals up to 1 1/2" square or round. Plugs standard 3/4" spacing. This holder must be seen to be appreciated for the extraordinary value offered.

### 510 Type Tube Isolantite Base

Lava bar insulation — Thoriated filament — the kind of tube we like to sell. Will take 750 volts on the plate. Ideal for the higher frequencies. Special... **\$2.59**

### Mounted Center Tapped Filament Transformers

2 1/2 v 8 amp — 2 1/2 v 3 amp — 5 v 3 amp	.....	<b>\$1.19</b>
2 1/2 v 4 amp — 7 1/2 v 2 1/2 amp — 7 1/2 v 2 1/2 amp	.....	<b>\$1.19</b>
2 1/2 v 4 amp — 5 v 3 amp — 7 1/2 v 2 1/2 amp	.....	<b>\$1.19</b>
5 v 3 amp — 5 v 3 amp — 5 v 3 amp	.....	<b>\$1.19</b>
5 v 3 amp — 7 1/2 v 2 1/2 amp — 7 1/2 v 2 1/2 amp	.....	<b>\$1.19</b>
2 1/2 v 6 amp — CT (midget)	.....	<b>\$.74</b>
5 v 3 amp — CT (midget)	.....	<b>\$.74</b>

**New! HAMMARLUND Heavy Duty** Transmitting Chokes 2.5 mh — 8 ohms dc res. 500 ma. .... **\$1.05**

**CARDWELL 510-B** split stator triple spaced cond., .0001 per section fb for tuning up to 200 watt phone job (limited quantity) \$32.00 list. Special, \$9.95

**4 Section RF Chokes** 125 ma — 2.5 mh — 50 ohms dc res. Isolantite form — pigtail mounting spec. .... **\$.39**

**Midget Power Transformers** 300 v ea. side c.t. 2 1/2 and 5 v fila. .... **\$1.19**

**Cased Power Transformers** 500 v ea. side c.t. 200 ma 2-7 1/2 and 1-2 1/2 fila. .... **\$2.95**

**Matching Cased Condenser Block** 2 and 4 mfd for use with above Trans. Special. .... **\$1.35**

**THORD. Cased Class B 210 Trans.**

T 5100 Input. .... **\$2.94**

T 5101 Output. .... **\$3.55**

**Thord. 15 H 250 MA chokes**. .... **\$2.95**

**Thord. 30 H 500 MA chokes**. .... **\$8.95**

**Gross 30 H 200 MA cased chokes**. .... **\$1.94**

**HOYT MOVING COIL METERS** 0-1 MA 3" wide flange meters. .... **\$2.90**

**HIGH QUALITY CASSED CONDENSERS** 2 mfd 2000 V. working. .... **\$3.95**

2 mfd 1000 V. working. .... **\$2.10**

**Pawdog Circular Wood and Bakelite** Cutter. .... **\$1.29**

**Molded Bakelite Sockets** — 4 or 5 prong, 12c; 6 prong, 15c; 7 prong small or large. .... **\$.24**

**TR-465 Mica Intermediates**. .... **\$.78**

**3 Wire Shielded Rubber Covered Mike** Cable per ft. .... **\$.05**

**2 Wire Shielded Rubber Covered Mike** Cable per ft. .... **\$.04**

**Ebonite Panels** 8 1/2" x 25" x 3/8" thick. .... **\$.95**

**Porcelain Base 50 Watt sockets** (side wiping contacts iron or white) .. **\$.99**

**DUBLIER** 6 mfd 900v d.c. working. .... **\$.79**

**Aerovox Mica No. 1450** .01-1000 volt cond. .... **\$.39**

**Sangamo** .002-5000 volt cond. .... **\$.90**

**50 watt Soldering Iron Spec.** .... **\$.79**

**3 Way mike Jack Spec.** .... **\$.39**

**3 Way mike Plug Spec.** .... **\$.59**

**X cut 80 or 160 M Crystals**. .... **\$2.35**

**Single or Double Button mike Trans.** .... **\$.89**

### Ward Leonard Vitreous Resistors 200-Watt 8 1/2" Long with Variable Sliders.

1000 ohms. ....	<b>\$.93</b>
2500 ohms. ....	<b>.99</b>
5000 ohms. ....	<b>.99</b>
10000 ohms. ....	<b>1.05</b>
15000 ohms. ....	<b>1.10</b>
25000 ohms. ....	<b>1.17</b>
35000 ohms. ....	<b>1.21</b>
50000 ohms. ....	<b>1.29</b>
60000 ohms. ....	<b>1.29</b>
80000 ohms. ....	<b>1.29</b>
100000 ohms. ....	<b>1.29</b>

### GUARANTEED TUBES

<b>Gross 210 Thoriated filament</b> . ....	<b>\$1.49</b>
<b>866 Heavy Duty Isolantite top</b> . ....	<b>1.45</b>
<b>888 or 871 Isolantite top</b> . ....	<b>.95</b>
<b>83, 47's, 46's</b> . ....	<b>.65</b>
<b>81's</b> . ....	<b>.80</b>
<b>1/2, 1/2 and 1 watt Neon Bulbs</b> . ....	<b>.35</b>

### GROSS CASSED POWER TRANSFORMERS

**650 v ea. side C.T. 350 ma fila. 2-7 1/2 v C.T. and 1-5 v** will give 500 v with choke input using 183 or 523. You can run your entire R.F. and class B off this trans. .... **\$5.50**

**750 v ea. side C.T. 300 ma fila. 2-7 1/2 v C.T. and 1-5 v**. .... **\$5.75**

**750-1000 v ea. side of C.T. 300 watts**. .... **\$6.65**

**850-1350-1500 v ea. side of C.T. 400 watts**. .... **\$8.70** (the ideal job to give 750-1000-1250 v D.C. with choke input)

**850-1350-1500 v ea. side of C.T. 550 ma**. .... **\$12.50**

**1500-2000 v ea. side of C.T. 800 watts**. .... **\$11.70**

### Hoyt Antenna Meter

Hot wire antenna meters. 2 1/2" mounting hole, flange 3" diameter, supplied in 1 1/2, 3 and 5 ampere ranges. Why work without antenna meters when you can buy them at this special price? .... **\$2.95**

### Hoyt Milliammeters and Voltmeters

Perfectly damped meters at a price. These are not to be confused with the usual inexpensive meters. 2" mounting hole, flange 2 1/2" diameter, supplied in the following sizes: 10 ma, 25 ma, 50 ma, 100 ma, 150 ma, 250 ma, 300 ma, 4 V. AC, 10 V. AC, 15 V. AC, 10 V. DC. Price each **\$1.30**, 3 for **\$3.60**.

### JOHNSON Transposition Insulators, \$0.09

Airplane Strain Insulators. .... **.05**

12" Antenna Insulators. .... **.45**

White or black 1/2" and 1" Stand offs doz. .... **\$.50**

White or Brown Beehive Ins., doz. .... **.45**

Isolantite spreaders 3" long, 10 for. .... **.35**

### UNIVERSAL ANTENNA COUPLING SYSTEM INDUCTANCES

Wound on threaded double X natural bakelite tubing, can easily be tapped with clips. .... **\$1.75** (use one coil for single-wire feed and two coils for two-wire systems)

### GROSS CASSED CLASS "B" TRANSFORMERS

Heavy Duty — for use with 210's or 46's per pr. .... **\$8.50**

A pair of cased high grade transformers for 46's. .... **\$4.65**

### GROSS CASSED CLASS "B" 800 TRANSFORMERS

Husky trans. for coupling to 5000 or 20000 ohm loads. .... **\$9.89**

**Filament Transformers shielded in metal cases, center tapped secondaries.**

2.5 Volt 10 amperes for 866's. .... **\$2.25**

12 to 12 Volts at 8 amperes. .... **\$2.25**

Special 10-12 Volt 7.5 ampere filament transformer, extra special. .... **\$.95**

### GROSS SPECIAL TRANSFORMER

600 volts each side of C.T. 200 MA 2 1/2 V. 10 amps, 5 V. 3 amps, 7 1/2 V. 3 amps. .... **\$3.39**

### FILAMENT TRANSFORMER FOR BRIDGE RECTIFIER

using 83 tubes 5 v-5 v-5 v at 3 amps C.T. — 3000 v insulation. .... **\$2.15**

### Cased Combination Filament Transformer

2 1/2 V. C.T. 10 amps for 866's 10 V. C.T. 7 amps for '50's or '52's 10000 volts insulation. .... **\$3.24**

### MIDGET DOUBLE SPACED NEUTRALIZING CONDENSERS 35 mmf.

— a real buy. .... **\$.59**

Pilot J-23 100 mmf. condensers. .... **\$.55**

Morrill uncased 2 mid 1000 V working. .... **\$1.59**

*20% deposit with all C.O.D. orders. Remit by M.O. Include postage*

**GROSS RADIO, INC.**

**51 VESEY STREET**

**NEW YORK CITY**

# GROSS CP-100

100-150 WATT CW TRANSMITTER

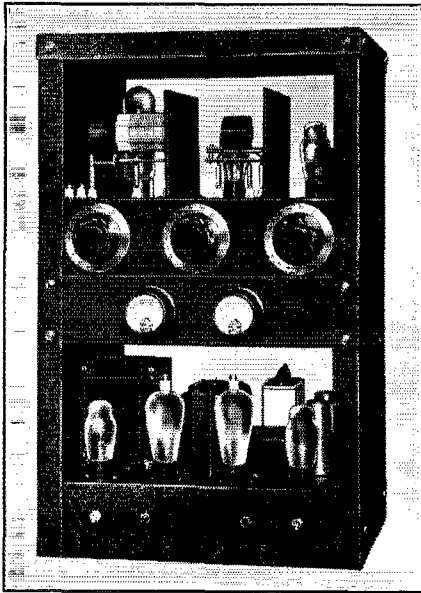

A complete crystal controlled medium high power C.W. transmitter having an output of 100 to 150 watts on all frequencies. Extra heavy duty power supplies, three separate filters are among the many features. Careful design and use of high grade components make it easy to obtain a fine signal and maximum output. "CP-100" — Kit, Less Tubes.....\$76.00 (Note the dials illustrated on the "CP-100" can be furnished on any of the transmitters at an additional \$3.50).

"CW 100" Kit, Less Tubes Price \$24.50

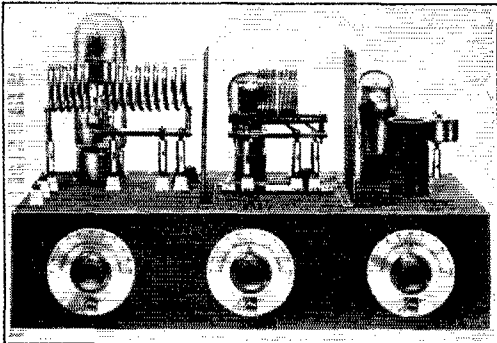

The smooth and easy handling of the "CW 100" even on 20 meters will be a revelation.

### 100 TO 150 WATTS OUTPUT

47 osc. — '10 buffer or doubler — output stage choice of '03-A, RCA 800 or Raytheon RK-18.

Special jacks are provided so that entire transmitter can be tuned with one milliammeter. All parts are supplied including one set of coils for either 20, 40, or 80 meters. When ordering transmitter with 160 meter coils add \$3.00 to the price of kit.

TRIPLE POWER SUPPLY KIT on matched chassis is available at \$36. This supply furnishes all filament voltages also 400-600-1200 volts, all with separate filters.

**GROSS RADIO, INC.**

**51 VESEY STREET**

**NEW YORK CITY**

# GROSS CB-25

25½ WATT PHONE & CW TRANSMITTER

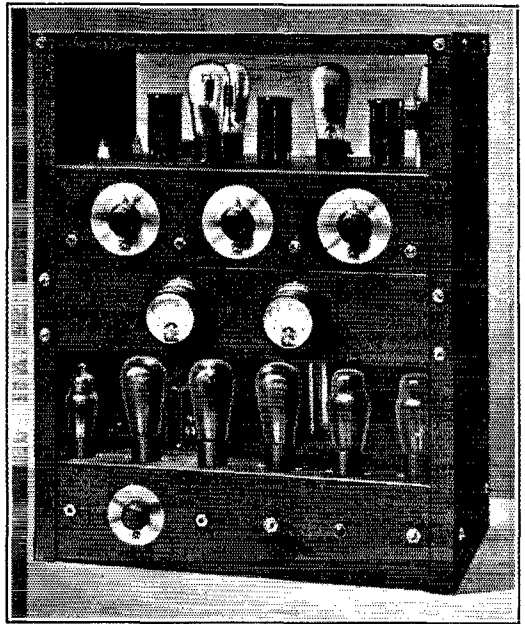

A complete class "B" Phone and C.W. Transmitter kit. Output 25 watts maximum Phone or C.W. Separate Power Supplies for Speech Amplifier and Crystal — heavy duty Supply for Class "B" and Class "C" Amplifier — Speech Amplifier is self-contained. A quality job thruout. Operates efficiently on all amateur bands including 20 meters. "CB-25" — Less Tubes.....\$66.00

LITERATURE NOW AVAILABLE

The GROSS "CW-25" Crystal Control Transmitter Kit — Less Tubes \$13.95

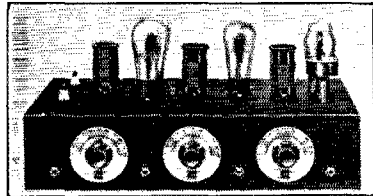

The "CW-25" transmitter kit due to its low cost makes it possible for anyone to own a modern crystal controlled station. A schematic hook-up and parts layout sheet as well as tuning instructions are furnished, thus enabling the most inexperienced operator to wire and put the set on the air, for real results. The "CW-25" is supplied with a shrivel finished sturdy metal chassis under which all parts are mounted, making the wiring and components dust-proof. A plug-in crystal holder is furnished with the kit. Only one milliammeter is required for tuning the transmitter and each stage is provided with a jack for this purpose. The "CW-25" uses one '47 as crystal oscillator, one '46 as buffer or doubler and two '46's in the amplifier stage. One set of three coils is supplied with the kit for 20, 40, 80 or 160 meter band. Any additional coils are 75 cents each.

80 or 160 M-xtals — \$2.75 each

The GROSS "CW-25" Power Supply Kit — Less Tubes \$8.75

Mounted on shrivel finished metal chassis which matches the "CW-25" transmitter. Heavy duty power transformer, chokes, condensers, bleeder, etc., supplied. Uses one '83 rectifier. This unit and the transmitter make a neat combination as well as an efficient one.

# ANALYZER OPERATION

*Simplified*

## OBSOLESCENCE

*Banished*

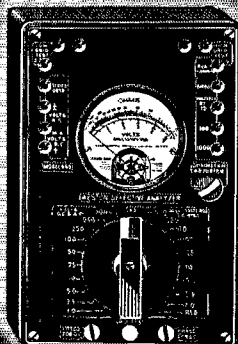

**WESTON  
MODEL  
665-6  
SELECTIVE  
ANALYZER**

Radio men everywhere are adopting the new Weston Method of Selective Analysis because it makes servicing easy and certain and banishes analyzer obsolescence. This improved method involves the Weston Model 665 Analyzer which has an exceptionally broad list of ranges and reads directly in fundamentals of volts, milliamperes and resistance; together with the simplified Model 666 Type 1A Socket Selector. This one Socket Selector cord and plug and its colored adapter combinations provide for all 4, 5, 6 and 7 prong tubes. Thus all necessary voltage, current and resistance readings, continuity and grid tests can be made in any kind of a radio receiver. And if new tubes with different bases are developed, it simply means purchasing an inexpensive socket adapter. Return the coupon for complete information... Weston Electrical Instrument Corp., 602 Frelinghuysen Avenue, Newark, N. J.

**WESTON**   
*Radio Instruments*

Weston Electrical Instrument Corporation  
602 Frelinghuysen Ave., Newark, N. J.  
Send Bulletin on Weston Radio Instruments.

Name .....

Address .....

City and State .....

## XU1U

Oakland, California

Editor, *QST*:

Recently we received a big batch of cards and correspondence forwarded by the QSL bureau of the Hong Kong Radio Transmitting Society. On looking over these cards and epistles, we find that evidently some one in or near the U. S. A. (most likely on a ship) has been using our call XU1U, working a lot of amateurs and leading them to believe they have really QSO'ed us in Canton, China. . . .

The fact is we have closed down station XU1U since April, 1933, and have been home in Oakland, California, ever since. While at XU1U, we have kept a 100% complete log book and have played the game squarely by QSL'ing everybody that sent us a card. . . .

Now we have in our possession quite a large number of cards claiming having worked us. . . . Most of these amateurs just lack an Asian card for claiming WAC certificate and the entreaties, supplications and pleas of these "buncoed" amateurs for our XU1U card are really heart-breaking and almost bring tears to our eyes when we read them. We hate to disappoint these amateurs, but we can't send them cards and acknowledge QSO's that didn't really occur. . . . We have gone to considerable expense and time in writing to them to explain the situation and we're certainly sorry for them.

We hope that the unknown person will see this letter, and if he is the right sort he'll stop using our XU1U call. At present there is only one real XU call on the air in China, and that is XU1A, owned by Mr. H. J. Prata, who is also in Canton, China.

In conclusion, we wish to request all amateurs that hear this fellow to call his attention to this letter or otherwise enlighten him.

—*Archie and Bennie Davis,*

*The one and original XU1U, now W6AFS*

## The Milwaukee 10-Meter Contest

4547 N. 21st St., Milwaukee, Wis.

Editor, *QST*:

To finish up the M.R.A.C. 10-meter *QST* party. . . . W6VQ won the prize offered by the club for the best work done during the contest by an outside station. W6VQ piled up a score of 260 on Milwaukee stations (worked, heard and heard by). W6CAL ran a close second with a score of 231.

W9NY took first place with a score of 276, W9IH second with 202, and W9EIH third with a score of 156.

As a number of outside stations submitted logs in this contest, I feel that they should be informed who won the prize.

No ten meter sigs have been heard in Milwaukee to my knowledge since January 1st, except locals, of course. The consensus of opinion

# KENYON DREADNOUGHT LINE

Better grade components for superlative performance . . . with features heretofore found only in built-to-order costly equipment for broadcasting, commercial and Government services . . . now in regular production . . . and offered at regular ham-pocketbook prices.

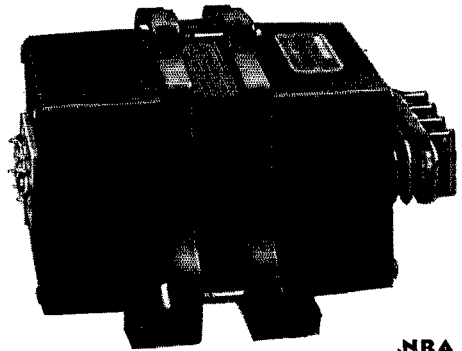

## Plate and Filament Supply Transformers

Better because they feature:

1. New end castings.
2. High insulation factor.
3. Poured compound, dissipating heat more efficiently than usual air.
4. Porcelain bushings on all high-voltage terminals.
5. All primary and secondary split windings brought to terminal board as such.
6. Typically KENYON Dreadnought grade . . . rugged, over-sized, advanced design, true craftsmanship.

### PLATE SUPPLY TRANSFORMERS

Type	RMS Volts	VA Rating		Test Voltage	Weight	Case	List Price
		Secondary	Primary				
TPA	4720	850	660	11,000	44 lbs.	4B	\$45.00
TPB	2360 2900	850	660				
TPC	2350 2860	405	290	7,000	31 lbs.	1B	22.00
TPD	2300 1770	810	573	7,000	43 lbs.	1B	37.00
TPE	1450 1200	315	220	5,000	30 lbs.	1B	21.00
	985	155	110	2,500	11 lbs.	LC-4	12.00

Voltagages given are those obtained under rated loads. The values given are overall voltagages, all secondaries being center tapped. All primaries are for 110/120V., 60 cycles. An electrostatic shield is incorporated between primary and secondary.

### FILAMENT TRANSFORMERS

Type	Tubes	Output		Insulation	Case	Weight	Price
		Volts	Amps				
TF866	2 — '66, '66-A	2.5 CT	10	11,000	3B	9 lbs.	\$9.50
TF872	2 — '72, '72-A	5.0 CT	20	11,000	3B	13 lbs.	15.00
TF800-1	10, 800, 825, RK-18	7.5 CT	6.5	5,000	3B	10 1/2 lbs.	12.00
TF800-2	10, 800, 825, RK-18	7.5 CT	13.0	5,000	2B	13 lbs.	15.00
TF03A	2 — 03A, 11, 42A, etc.	10 CT	6.5	5,000	3B	12 lbs.	12.00
TF04A	'49, 04A, etc.	11 CT	10	5,000	2B	13 lbs.	15.00
TF356	1 — 83	5.0 CT	3.0	3,000			
	5 — 56's, 57's, etc.	2.5 CT	5.0	3,000	3B	9 lbs.	8.50
	2 — 46, 59, 2A3	2.5 CT	5.0	3,000			
	2 — 66	2.5 CT	10	4,000			
TF6610	2 — 41, 42, 10, etc.	7.5 CT	2.5	2,500	3B	12 lbs.	12.00
	2 — 41, 42, 10, etc.	7.5 CT	2.5	2,500			
TF6603A	2 — 66	2.5 CT	10	10,000			
	1 — 03A, 11, 42A, etc.	10.0 CT	3.25	3,000	2B	14 lbs.	15.00
	1 — 03A, 11, 42A, etc.	10.0 CT	3.25	3,000			

Watch this page for further data on this line. (See February and March issues for previous data). If interested, write for full particulars and bulletin. Your nearest amateur radio supply house has these components on display and in stock for your inspection and immediate needs. Supplied at usual amateur discount.

TO JOBBERS AND DEALERS: This line is being sold through a select group of merchandisers in exclusive territories. Territories still open. Write for proposition.



## KENYON TRANSFORMER Co., Inc.

122-124 Cypress Avenue :: :: New York City

Say You Saw It in QST — It Identifies You and Helps QST



# YOU GET ACTION

From LEEDS—because we carry the largest stock of Amateur Equipment in the Country. Our prices are low and shipments prompt.

## ACME DELTA

Designed by Dellenbaugh — the country's foremost "filter fixer." Adequate design and rugged construction make it a little more costly than "run of the mill" units. These self same features make possible a five year guarantee against any failure. These facts can readily be appreciated by those to whom quality comes before price. "It's cheaper in the long run." 40% discount from prices in December 1933 *QST* pages 93 to 96.

*Bulletin on request*

## General Radio Specials

GR No. 374-N .00035 SLF . . \$1.25  
 GR No. 247-M .00025 Vernier \$ .95  
 GR No. 374-B .000125 SLF \$1.25  
 GR No. 677-U coil form. . . . \$ .35  
 GR No. 247-K .00025 . . . . . \$ .75  
 General Radio No. 369 choke coil  
 98H . . . . . \$ .69

We carry a complete stock of G.R. amateur equipment. *Bulletin No. 935* describing it is yours for the asking.

**ALL RCA transmitting and receiving tubes in stock at lowest prices.**

## TRIPLETT METERS

and test equipment are becoming increasingly popular. Reasonable prices and quality of construction make them outstanding. 3 1/2" Millimeters, bakelite cases, 0-5 to 0-1000 MA, \$3.75

Thermo Ammeters 0-1; 0-2 1/2 or 0-5 amp . . . . . \$6.54

## WING Transceiver \$18.25 with Tubes

5 Meter Picard antenna . . . . \$2.50  
 New collapsible type . . . . . \$3.95

## The LEEDS FREQUENCY CHECKER

is going over in great style. Get 10 kc checking points at any time with "Bureau of Standards" accuracy. Send 10c in stamps for the dope.

*Complete kit, \$5.31*

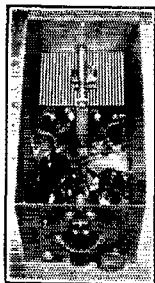

## LEEDS BAND SPREAD MONITOR

furnished complete — Sylvania 30 tube, A and B batteries and 20-40-80 coils. 50 division spread on 20 meters — 35 divisions on 40 meters and 70 divisions on 80 meters. Unconditionally guaranteed.

**\$9.95**

## The New SYLVANIA 830 B in Stock

A pair in class B will give 190 watts of audio power. Price, each . . . . . \$10.00

Sylvania 830 . . . . . \$8.75

The Sylvania 210 will increase your output over any other 210; each . . . . . \$4.75

## JEWEL Model 165 Thermo Ammeter

0-1 amps only . . . . . \$4.95

Jewell model 190 A.C. voltmeters 0-8v; 0-10v; 0-15v; each. . . \$3.50

## Navy Type Telegraph Key

List \$3.60  
 Navy knob — 1/2" Tungsten contacts. Only a few left at \$1.15

With regular knob . . . . . \$ .95  
 Leeds transmitting key, spec. . . . \$ .65



## NATIONAL

From a WGS-1 insulator to the AGSX receiver in stock.

## 40% Discount

We are selling plenty of the midget relays at 29c each. Get yours before the supply is exhausted. Operates on one dry cell. One pole, double throw; the other single throw. Can be used for keying low powered transmitter.

## American Transformers

We carry a complete stock of the new American line.

*Descriptive bulletin on request*

## Wright Decoster Speakers

Wright Decoster 6" dynamic speaker, with 2500 ohm field and pentode output transformer, \$2.75

Wright Decoster 5" midget dynamics with 300 ohm field and pentode output transformer, \$2.25

Special 8" Magnetic unit with output transformer for 59 tube; suitable for use with FB-7, \$5.25

## HAMMARLUND PRODUCTS always in stock at lowest prices

MC 140-M split stator 70 mmf effective capacity; O.K. in unmodulated stages up to 750 volts. . . . . \$2.35

TCD 225X effective capacity 110 mmf; FB of 50 watters. . . \$6.47

TCD 100A effective capacity 51 mmf; suitable for 853's; 860's or 204A's. . . . . \$10.59

Comet Pro receivers in stock

*Write for descriptive bulletin*

We cannot publish a catalog and help support the ARRL through the medium of our *QST* advertising and at the same time maintain our low prices. If you don't see it in our "Adv" take any up-to-date catalog for price reference on any standard amateur equipment. We will meet or beat the price.



45 Vesey Street, New York City

New York Headquarters or Transmitting Apparatus

**CONFIDENCE** — Recently a customer sent us an order with a signed blank check to cover its cost. Another in far away Morocco just deposited a substantial sum with us to cover future orders. We appreciate this confidence in our honesty and ability to fill orders properly and promptly. When you are in a hurry try it — it works FB

## WE PRESENT A NEW CATHODE RAY OSCILLOSCOPE

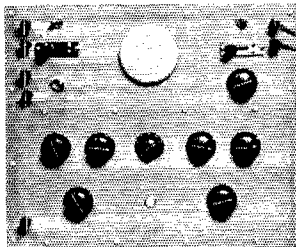

This instrument embodies all features ordinarily contained in only the highest priced cathode ray equipment.

- Controlled linear sweep 0-150,000 C.P.S.
- Controlled external sweep.
- Freq. locking device for sweep frequency.
- Picture centering adjustments.
- Wide range focus adjustments.
- Complete component shielding.
- Unit is self contained and includes batteries and 110v-60 cycle power supply.
- Tubes RCA 906-885-234-281-280.

COMPLETELY EQUIPPED READY TO USE

**\$85 f.o.b. Newark**

### TUBES

to fit the depression pocketbook of the amateur fraternity. These tubes are first class products and carry our absolute guarantee for 90 days.

281.....\$ .90 211.....\$7.75  
866—H.D... 1.50 203A..... 8.95  
.210—15W... 1.15 845.....10.00

### SPECIAL

Dubilier 903 6mfd-900v.....\$1.25  
" 902 6 mfd 700v..... 1.00  
The best buy in filter condensers ever offered

In stock for RCA 906 — \$18.00  
immediate RCA 885 — 2.00  
delivery RCA 800 — 10.00

POWER SUPPLY — 1200 v. — 250 ma and  
600 v. — 250 ma

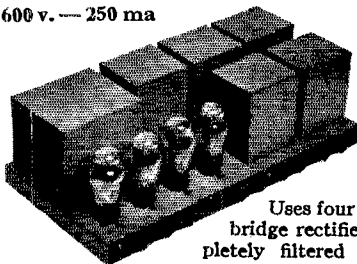

Uses four 83's in a bridge rectifier—completely filtered in both voltage legs.

**\$35.00**

PLATE TRANSFORMER — two 7½ and two 2½-volt fil. windings — 750-750 v.— 160 mils.....\$3.50

### EXTRA SPECIAL

Filament Transformer — 110 v. pri. — 2 separate 7½ v. center tapped windings — 3 amps., each... **\$1.35**

We build transmitters to your specifications  
Open Evenings — 7 to 9.30 p.m.

**KALTMAN & ROMANDER**  
62 Court Street Newark, New Jersey

I believe in all justice to the old timers it can be safely said that they do their share, and more, in cooperating, and that there would be less controversy if the beginners tried to view the situation from the other side of the fence. . . . There are always a few in every line of endeavor who spoil it for the rest, but the majority shouldn't be judged by those few. The golden rule works in amateur radio as well as in anything else.

I have used my own case as an example . . . in the hope of promoting a little better feeling between the gang. It is not the intention of this letter to serve notice that I do not care to QSO a beginner.

—Walter L. Glover, W1VB

## Financial Statement

BY ORDER of the Board of Directors the following statement of the income and expenses of the American Radio Relay League, Inc., for the fourth quarter of 1933 is published for the information of the membership.

K. B. WARNER, *Secretary*

### STATEMENT OF REVENUE AND EXPENSES FOR THE THREE MONTHS ENDED DECEMBER 31, 1933

REVENUE	
Advertising sales, QST.....	\$13,461.70
Advertising sales, Booklets.....	260.00
Advertising sales, Handbook.....	793.00
Newsdealer sales, QST.....	10,509.48
Handbook sales.....	4,172.64
Booklet sales.....	2,445.31
Membership dues.....	14,248.39
Membership supplies sales.....	2,182.64
Interest earned.....	238.42
Cash discounts earned.....	171.98
	\$48,483.56
<i>Deduct:</i>	
Returns and allowances.....	\$ 2,627.72
Cash discounts on sales.....	271.67
Exchange and collection charges.....	5.92
Increase of provision for newstand returns of QST.....	317.32
	3,222.63
Net Revenue.....	\$45,260.93
EXPENSES	
Publication expenses, QST.....	\$10,880.94
Publication expenses, Handbook.....	2,029.41
Publication expenses, Booklets.....	963.91
Membership supplies expenses.....	1,082.19
Salaries.....	17,176.12
QST forwarding expenses.....	508.07
Telephone and telegraph.....	519.67
Postage.....	1,970.56
Office supplies and general expenses.....	1,782.08
Rent, light and heat.....	839.29
Traveling expenses.....	895.37
Depreciation of fixed assets.....	254.20
Communications Dept. field expenses.....	43.66
Headquarters station expenses.....	33.47
Bad debts written off.....	836.46
Federal tax on checks.....	6.32
Total Expenses.....	39,821.72
Net Gain from Operations.....	\$5,439.21



# You've Wanted Cascade Pre-selection

Here it is . . . just  
*where you need it!*

**I**N the past, lack of adequate preselection has limited the efficiency of most short-wave receivers.

Now, however, you can enjoy the perfect reception that cascade preselection gives you. In General Electric's new *all-wave* model, there are two stages of radio frequency (*with a single tuning control*) ahead of the first detector. This assures sharper tuning and minimum images. Both stages are on the 8-18 megacycle band where they're needed to give additional gain in sensitivity; one stage, on the 540-10,000 kilocycle band.

Easy and accurate tuning is made possible by the airplane type illuminated dial on which all four bands are graduated in kilocycles and megacycles, and short wave broadcast bands are marked in meters.

## FEATURES

Superheterodyne circuit.

Continuous tuning range from 540 to 18,000 Kilocycles (555-16.7 meters) in four frequency ranges.

Coil switching eliminates inconvenience of changing coils.

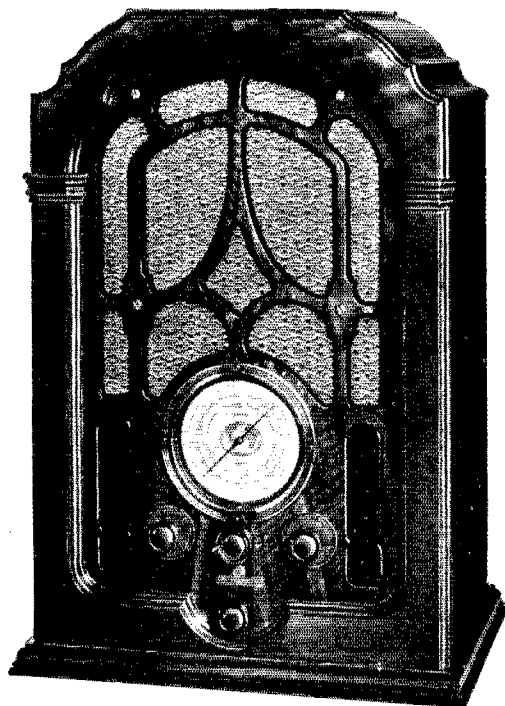

General Electric All-wave Radio Model K-80...  
Price \$92.50.  
Price slightly higher in West and South. Subject to change without notice.

Model K-80 is a set you can recommend to your friends who are interested in short wave reception. It's easy to operate, and gives the outstanding performance that is expected of a high-quality set.

Automatic volume control.

Vernier tuning; double reduction vernier, 55:1 ratio.

Class "B" output.

Large dynamic speaker.

Tone control.

You will be interested in seeing and operating this remarkable development at your local G-E Radio Dealer's.  We cordially invite you to do so.



**GENERAL  
ELECTRIC  
RADIO**

Radio Sales Section R-674  
GENERAL ELECTRIC COMPANY  
Merchandise Department  
Bridgeport, Conn.

Please send me, free of charge, full technical details and circuit diagram of the new General Electric All-wave set.

Name \_\_\_\_\_

Street \_\_\_\_\_

City \_\_\_\_\_ State \_\_\_\_\_

( ) Check here if you do radio service work.

A "Ham" Shack in Philadelphia  
for Hams and by Hams

# RADIO ELECTRIC SERVICE CO., INC.

Distributors for:

Hammarlund — RCA-deForest — Lynch  
Burgess — National — Pyrex  
American Microphone — Thordarson  
Flechtheim — Ward Leonard — Cardwell  
Sylvania — Weston — Bliley  
Triplett — Johnson — Vibroplex



Complete Line of **PHONE** and  
**CW EQUIPMENT**

## REPLACEMENT PARTS

Suitable for Low Power Rigs  
Always on Hand



## NEW DEAL SPECIALS

Resco Power Supply for FB7  
Excellent Filtering

**\$7.50 COMPLETE**

Resco 5-Tube AC Receiver Complete with  
Built-in Power Supply, Including Tubes and  
Coils from 15 to 225 Meters. . . . . **\$19.95**

Have You Tried the NEW

## "GO-DEVIL BUGS"?

STOP IN!

# RADIO ELECTRIC SERVICE CO., INC.

N.E. Cor. 7th and Arch Streets  
PHILADELPHIA, PA.

BRANCHES:

303 W. Baltimore Street, Baltimore, Md.  
1024 Hamilton Street, Allentown, Pa.

## Standard Frequency Transmissions

STANDARD frequency transmissions from W1XP have been suspended temporarily for changes and repairs in the frequency standard equipment at the Round Hill Station. Schedules of the S. F. System's Midwest and Pacific Coast stations, W9XAN and W6XX, continue as usual, according to the following schedule:

Date	Schedule	Station	Date	Schedule	Station
Apr. 6	B	W9XAN	May 4	B	W9XAN
	B	W6XX	May 9	C	W9XAN
Apr. 11	C	W9XAN	May 11	B	W9XAN
Apr. 13	B	W9XAN		A	W6XX
	A	W6XX	May 16	BB	W9XAN
Apr. 18	BB	W9XAN	May 18	BB	W6XX
Apr. 20	BB	W6XX		A	W9XAN
	A	W9XAN	May 19	BX	W6XX
Apr. 21	BX	W6XX	May 20	C	W6XX
Apr. 22	C	W6XX	May 25	A	W6XX
Apr. 27	A	W6XX			

### STANDARD FREQUENCY SCHEDULES

Time (p.m.)	Sched. and Freq. (kc.)		Time (p.m.)	Sched. and Freq. (kc.)	
	A	B		BB	C
8:00	3500	7000	4:00	7000	14,000
8:08	3600	7100	4:08	7100	14,100
8:16	3700	7200	4:16	7200	14,200
8:24	3800	7300	4:24	7300	14,300
8:32	3900		4:32		14,400
8:40	4000				

Time (a.m.)	Sched. & Freq. (kc.)	
	BX	
6:00	7000	
6:08	7100	
6:16	7200	
6:24	7300	

The time specified in the schedules is local standard time at the transmitting station. W9XAN uses Central Standard Time and W6XX, Pacific Standard Time.

### TRANSMITTING PROCEDURE

The time allotted to each transmission is 8 minutes divided as follows:

2 minutes—QST QST QST de (station call letters).  
3 minutes—Characteristic letter of station followed by call letters and character of frequency. The characteristic letter of W1XP is "G"; that of W9XAN is "O"; and that of W6XX is "M".

1 minute—Statement of frequency in kilocycles and announcement of next frequency.

2 minutes—Time allowed to change to next frequency.  
W9XAN: Elgin Observatory, Elgin National Watch Company, Elgin, Ill., Frank D. Urie in charge.  
W6XX: Don Lee Broadcasting System, Los Angeles, Calif., Harold Peery in charge.

—J. J. L.

## Joint Meeting I.R.E.—U.R.S.I.

Preliminary plans have been announced for a joint meeting of the Institute of Radio Engineers and the American section of the International Scientific Radio Union, to be held in Washington at the National Academy of Sciences Building on April 27th. This is the first of a series of joint meetings of the two organizations, to be held annually in the spring in Washington.

An important program of scientific papers will be presented, dealing chiefly with the more fundamental aspects of radio problems, largely research in the ionosphere and in the field of ultra-high-frequency propagation. An increasingly large number of scientists and scientific societies are

# SPRING OVERHAUL

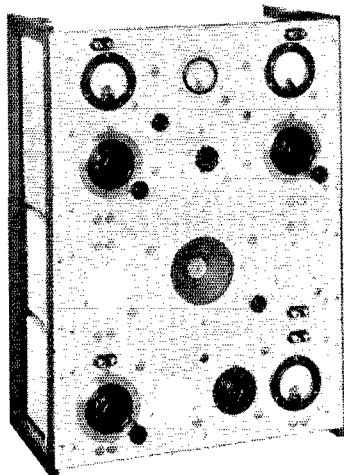

**UNIT PANELS** — The G. R. universal standard panel units and racks will be the foundation of a permanent workmanlike arrangement for transmitter and receiver. Panels drilled for standard parts. Easily changed over into different circuits. Cover plates, buttons, etc., included.

Price range: \$4.00—\$6.00

**DIALS AND KNOBS — NEW TYPE** — (shown on panel). Fluted for easy grip. Moulded bakelite with skirt.

Price range: Dials ..... \$1.00—\$2.00  
Knobs..... \$0.25—\$0.50

## SHIELDED PLUG-IN INDUCTORS

— Improve the appearance behind the panel also. Coil forms, shields, plug bases, all available to form neat efficient assembly which can be removed through the front of the panel.

Price: Inductor Form. . \$0.85  
Base..... \$0.65  
Shield..... \$1.50

Have you read about the new G. R. line of parts for amateurs? Send for Bulletins 934-935.

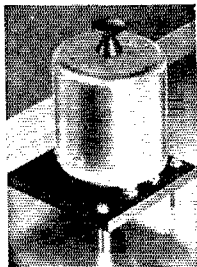

# GENERAL RADIO COMPANY

CAMBRIDGE A, MASSACHUSETTS

**ALUMINUM BOX SHIELDS** Genuine "ALCOA" stock, silverdip finish, 5 x 9 x 6, \$1.65. 10 x 6 x 7, \$2.65. Any size to Order. **SOMETHING NEW!** Your call letters, or any marking for your panel, on BLACK aluminum ribbon. Looks like engraving on bakelite. Sc up to 2 inches, 5c each additional inch. Sample 8c. U.S. Army V.T. 1 tubes 35c, 10 for \$2.50. Foil for condenser or velocity mike 1/2 mil., 25c ft. New Master Teleplex on demonstration.



**BLAN, the Radio Man, Inc.** 177 Greenwich St. New York City

## METAL-WORKING LATHE

New designs and mass production methods make this amazing bar gain possible. Complete metal working lathe with compound slide-rest, improved three-jaw chucking device, 6" swing, 24" overall length, 24 lbs. Send postcard for catalog and 10-day trial offer, or save time and send \$1. balance plus express C. O. D. Wood-turning lathe \$4.50. Extra bed-lengths, 80c per ft. Attachments for milling, grinding, sanding, saw-table, etc., available at low prices.



**AMERICAN MACHINE & TOOL CO., Dept. Q** 200 BROADWAY NEW YORK

Technical  
Training Station

Phone C. W.

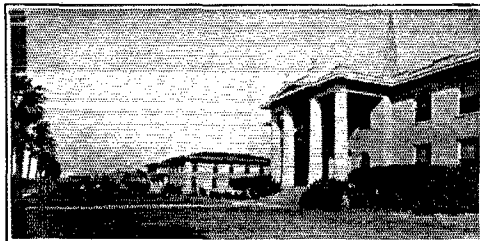

Studio Technique  
Guaranteed

**KFDL**

1000-Watt 560  
W. E. Kilocycles

**I**N 3 to 7 months we train you to secure Amateur, Commercial Telegraph Second-class, and Radiotelephone First-class government licenses. Course consists of Wireless Code, Radiophone, Microphone-Studio Technique, Television, Service, Police, and Aeronautical Radio. We are authorized to teach RCA Institutes, Inc., texts. At completion of your course you receive practical studio technique experience in broadcast studios located in our administration building, and operating experience on KFDL (1000-Watt W. E. Commercial Broadcast Station), and WPA, 4000-Watt Commercial Wireless Station. Return coupon for details.

## PORT ARTHUR COLLEGE

Port Arthur (world-known port) Texas

Name .....

Street or Box.....

City and State.....



# "I'm not GAMBLING when I employ Radio men with C.R.E.I. DIPLOMAS"

So many executives have expressed that confidence in CREI Graduates that their remarks have become a challenge to CREI to continue to train men who are a credit to the Institute, the Industry and themselves.

## There NEVER can be Too Many GOOD MEN!

The lower fields of all industries are always overcrowded . . . but even in depression-times . . . GOOD MEN were needed for GOOD JOBS . . . NOW with conditions improving . . . DON'T WAIT for a good opportunity before preparing yourself to handle it . . . BE PREPARED.

There must be something to CREI Training when men will quit jobs to attend the Residence School . . . or put in additional hours studying the extension course while working on ships or in service and broadcast jobs. The globe is dotted with CREI students who appreciate its advantages . . . its well planned courses and the convenient methods of paying for them.



### 3 Convenient forms of Study

Home study and residence courses or a combination of them both, to meet the needs of all. Our one year Residence Course is recognized as the most comprehensive in the entire country.

Just off the Press

New 40-Page Catalog - Write Today

# CAPITOL RADIO ENGINEERING INSTITUTE

E. H. RIETZKE, President

14th and PARK ROAD, N.W.  
WASHINGTON, D. C.

Dept. Q-4

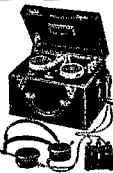

## THE INSTRUCTOGRAPH (Code Teacher)

The Scientific, easy and quick way to learn the code. Send a post card today for literature. Machines, tapes and complete instructions for sale or rent. Terms as low as \$2.00 per month. Rental may be applied on purchase price if desired. Rent for a month. If the Instructograph meets every requirement, buy it. If not, send it back.

INSTRUCTOGRAPH CO., 912 Lakeside Place, Chicago

## PANELS - BAKELITE - RUBBER - ALUMINUM All Sizes Cut to Order BAKELITE TUBING & RODS

ALUMINUM DRILLING, ENGRAVING & SPECIAL WORK  
ALUMINUM CHASSIS - Threaded brass studs for 6/32 screws. Length from 1/2" to 6" - price 5c to 30c.

Insulating bushings for all size shafts 75c to \$1.90 per dozen



Couplings in brass or bakelite - 15c



UNITED RADIO MFG. CO.

Est. 1923

Transmitting frames and racks. 191 Greenwich St., New York

## Presenting THE NEW AND IMPROVED HARVEY TRANSCEIVER

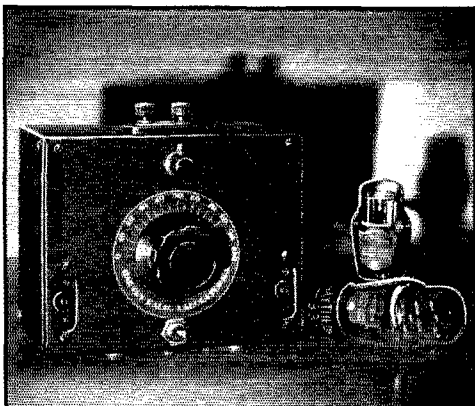

Now available in three models to suit every operating condition on 56 Mc. These units offer reliable voice communication over short distances with a minimum of expense, size, and weight.

1. 6-volt model, ideal for automobile and plane work . . . . . \$16.95
2. 2-volt model for portable use operating from the smallest B batteries . . . . . \$17.75
3. AC model for fixed use, employing our special power pack . . . . . \$18.50

Above prices do not include tubes or power supply

Each individually wired and tested unit measures approximately 5 x 6 x 3 1/2 inches, weighs 4 1/2 lbs., and is housed in an attractive metal case finished in black crackle.

The Byrd Expedition en route to the Antarctic used several Harvey Transceivers to maintain reliable ship to shore communication at Easter Island. A 6-volt model was used with great success by the M. I. T. meteorological plane while making 56 Mc. tests. (See Feb. QST.) Frank Hawks with an approximate duplicate of the M.I.T. installation in his plane contacted stations in excess of 100 miles.

We welcome inquiries from Amateurs and other organizations concerning the novel possibilities of the Transceiver. It will pay you to investigate.

Write for information on the above units and a descriptive pamphlet on the Tritet, companion RK-18 amplifier and accessories. We also have available an aluminum chassis kit for the "One tube Xtal Transmitter" as described by George Grammer in March QST.

**HARVEY RADIO LABORATORIES**  
12 Boylston Street, Brookline, Mass.

# AT YOUR FINGERTIPS



## ALL

- ▶ developments in the high-frequency field
- ▶ transmitting and receiving circuits of interest to you
- ▶ regulations governing amateur radio communication
- ▶ good practical ideas of active amateurs

will be found in your file of *QST*, but — are yours in any semblance of order? Can you say that you can find information you need without a great deal of research? If you cannot, you need *QST* in BINDERS—properly indexed. You will find that they will more than pay for themselves. Single copies may be removed at will but because of the way that the binder opens (so that the copy is flat and easily read) there should seldom be a need to do this.

Each *QST* BINDER holds twelve issues of *QST* and the yearly index. It is a good-looking binder, sturdily constructed to not only keep your file in order but also to keep your copies in good condition. You will find it a good investment.

Priced at

**\$1.50 postpaid**

**AMERICAN RADIO RELAY LEAGUE**

West Hartford, Connecticut

## New Attenuator Control

THE progressive 'phone operator will be interested in a new "T" type attenuator control which recently has been made available. Designed primarily for volume control in input or output circuits of public address systems, it can be used equally well in the speech circuits of 'phone transmitters. The accompanying photograph shows the construction, which consists of a three-gang twelve-point tap switch with wire-wound resistor elements, giving eleven steps of 4 db. each from 0 to 44 db. The attenuator will safely carry eight watts of signal energy, and is made in impedance values of 200 and 500 ohms. A shield can fits over the unit and protects it from dust and damage. The attenuator is  $2\frac{1}{2}$  inches in diameter and  $3\frac{1}{4}$  inches deep.

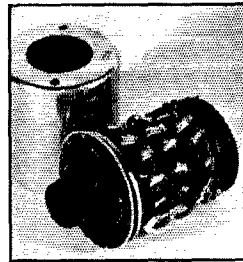

The new "T" attenuator control is made by Electrad, Inc., New York City. Fixed "T" type attenuators made in standard values of 5, 10 and 15 db. loss, for either 200- or 500-ohm lines, also are available from the same concern.

## The Operation of R. F. Power Amplifiers

(Continued from page 18)

the d.c. plate current and low output current at resonance are indicative of low plate efficiency, as would be expected. Detuning the secondary slightly either side of resonance results in a rapid rise in load current with a decrease in plate current as the optimum plate circuit impedance is approached.

It will be noted by comparison with the peak values of Fig. 14 that the same maximum power output and plate currents are obtained for both conditions of coupling and it might, at first thought, seem desirable to operate with the coupling greater than the optimum value and the secondary (or antenna) detuned as for one of the peaks of Fig. 15. Such is not the case, however, when one considers the curve showing the primary capacity variation required to keep the tank tuned to resonance. For a given degree of secondary detuning—resulting from a swinging antenna, temperature or humidity effects or the like—a much greater detuning effect is experienced on the plate tank circuit for the increased coupling.

The practical-minded amateur will immediately inquire as to the usefulness of all these relations. It is readily recognized that at lower frequencies, where calculations and measurements can be applied with confidence, the design of the power amplifier tank circuit and load coupling devices can be accomplished with a

LOOK  
AT  
THIS  
"A"

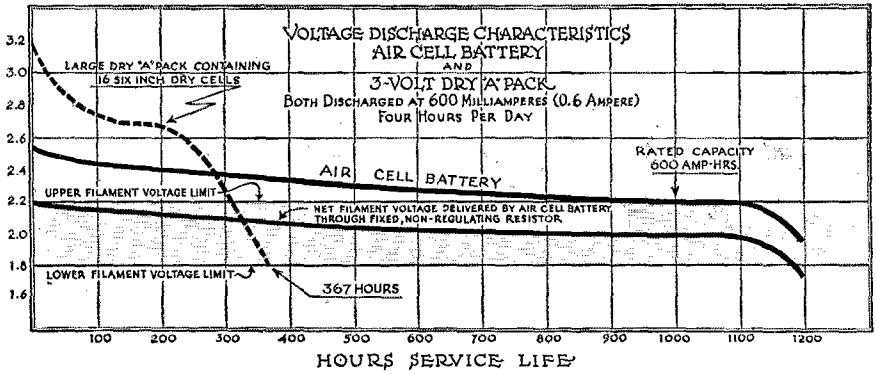

## BATTERY PERFORMANCE CURVE

The unique, flat discharge curve of the Eveready Air Cell "A" Battery insures ideal filament voltage at all times for 2-volt tubes. It cannot be high enough to cause tube burnout—or low enough to cause weak reception.

No rheostat or control needed

**NATIONAL CARBON COMPANY, Inc.**  
General Offices: NEW YORK, N. Y.  
Branches: CHICAGO, SAN FRANCISCO  
Unit of Union Carbide and Carbon Corporation



### GET A FREE COPY OF THIS NEW BOOK

"The Inside Story of "A" Batteries For Air Cell Radio." Send the coupon.

National Carbon Company, Dept. Q-2  
30 East 42nd Street, New York City  
Please send me the Air Cell Book



Name \_\_\_\_\_

Address \_\_\_\_\_



New!  
**UNIVERSAL**  
Stretched Diaphragm Type  
1934 MODEL "X"

Here is microphone value without precedent! A brand new 1934 model, stretched diaphragm type. Full Diaphragm Protection 2-button microphone, listing at only \$10.00! Exceeds every reasonable requirement for quality performance.

**UNIVERSAL MICROPHONE CO., Ltd.**  
424 Warren Lane Inglewood, Calif., U. S. A.

WE STOCK

**SYLVANIA AND RAYTHEON**  
TRANSMITTING TUBES

HAMMARLUND "PRO" AND FBX NATIONAL

Write for free catalog

**CAMERADIO**

603 GRANT ST. PITTSBURGH ~ PA.

## TRANSMITTER RACKS

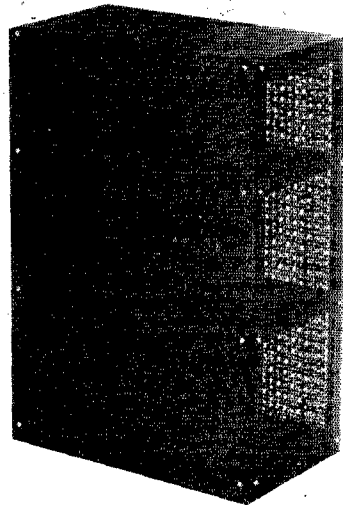

- Made of 22 gauge auto metal
- Baked black crackle enamel
- Adjustable shelves
- Perforated covers
- Assembled in 30 minutes

18" x 16" x 9".....\$4.00  
24" x 16" x 9"..... 5.00  
30" x 16" x 9"..... 6.00

Extra Shelves, 60c

Send for Catalog

## RADIO LABORATORIES

1515 Grand Avenue

Kansas City, Mo.

# NATIONAL *Victron* TRANSPPOSITION BLOCK

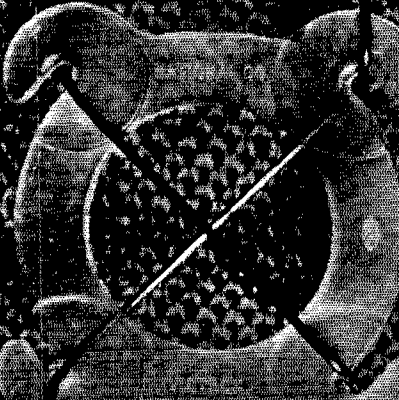

**EFFICIENT—LIGHT—TOUGH**  
77 TO THE POUND

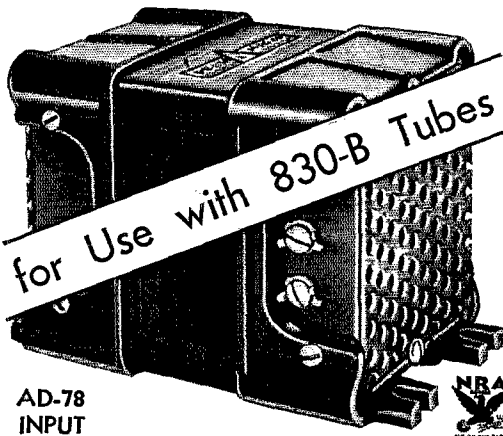

AD-78  
INPUT

## ACME~DELTA COUPLING TRANSFORMERS

For use with the 830-B tubes, Delta has now ready AD-78 Input Transformer;—2A3 Class "A," to 2-830-B Class "B," and AD-79 Output Transformer;—2-830-B tubes to Class "C." R.F. List prices AD-78, \$13.75;—AD-79, \$30.50; subject to usual 40% discount.

Delta now has C-Bias Rectifier parts for Transmitter use. Write for new Bulletin DL48-33.

F. S. Dellenbaugh, Jr.  
Pres. &  
Chief Engr.



G. E. M. Bertram  
Treas. &  
Gen. Mgr.

knowledge of these relations. At amateur frequencies, and with the limited measuring equipment usually available, merely qualitative checks can be made. However, an understanding of the underlying principles will prove helpful. A simple check on the load coupling to the power amplifier tank can be easily made by increasing the coupling, tuning the secondary (feeder or antenna) condenser for maximum load current, and keeping the plate tank always tuned to resonance (minimum plate current dip). If a slight increasing of the coupling results in the characteristic double peaked output as the secondary is tuned either side of resonance, then the coupling can be decreased until a single peak is obtained and one can rest assured that the optimum coupling has been secured. It should be noted that, since the optimum value of the tuned circuit impedance varies with the conditions of bias and excitation on power amplifier, the optimum coupling value will vary likewise and must be rechecked after each adjustment of these parameters in order to insure the best performance. If this coupling check does not show the double peak output effects, then there is insufficient range of coupling and the physical arrangement, size and constants of the coupling coils should be changed.

These principles of tuned circuits and load coupling apply equally well to all of the usual types of power amplifier circuits, single tube or push pull, with triode or screen grid tubes. This coupling check does not apply, however, for self-excited oscillators since the characteristic frequency jump takes place when the secondary tuning is varied with close coupling.<sup>5</sup>

### THE TANK CIRCUIT $L-C$ RATIO

The ever present question of the  $L-C$  ratio in power amplifier tank circuits will bear some consideration. Since the problem of adequate frequency stability is associated with the master oscillator and exciter unit, the  $L-C$  ratio of the final power amplifier circuit plays rather a minor role in determining the frequency stability of the output. Of greater importance is the consideration of the harmonic voltages developed across the power amplifier tank and their transfer to the load. An excessively high  $L-C$  ratio results in an insufficient degree of circulating volt-amperes of stored energy in the tank circuit, with a great increase of harmonic energy due to the departure of the plate voltage swing from a pure sine wave. Similar effects can also result from excessively high bias and grid excitation voltage. A push-pull final amplifier arrangement is inherently better in these respects and can operate efficiently with a much higher  $L-C$  ratio of tank circuit than a single tube amplifier for the same percentage of harmonic energy.

Since we have found that, by properly coupling the load, the tuned circuit impedance of the tank can be decreased to the optimum value, independently of the  $L-C$  ratio, it might seem that the latter was of little importance. Considering

<sup>5</sup> Robinson, "Operating Principles of V.T. Oscillators," *QST*, Nov., 1929.



# Putting Efficiency Ahead of Price



FBX-A Receiver manufactured by the National Co. showing Bliley Mounted Crystal

Bliley Crystals are used by all the leading manufacturers of radio transmitting and receiving equipment . . . broadcasting or amateur. They know that it pays to buy the best at any cost . . . and yet, Bliley's are sold at the lowest prices consistent with the best quality — power, precision and performance.

YOU will find it pays to put efficiency ahead of price in the purchase of crystals. Buy BLILEY'S and be sure.

**BLILEY PIEZO-ELECTRIC CO.**  
226 Union Station Bldg. Erie, Pa.



Special Crystals also manufactured between 20 Kcs and 15 Mcs

It wasn't price which figured in the selection of Bliley Crystals for use by Admiral Byrd's Expedition

... IT WAS THEIR DEPENDABILITY

It isn't price which is the determining factor in the purchase of Bliley Crystals for use by the U. S. Government

... IT IS THEIR DEPENDABILITY

It isn't price which induces the National Company, manufacturers of FBX-A and AGS-X receivers, to choose Bliley Crystals as standard equipment in their new single signal receivers

... IT IS THEIR DEPENDABILITY

Type	Mc Band	Supplied Within	Precision	Furnished	Price
BCX	1.7, 3.5, 7.0	±25Kc*	0.05%	Unmtd.	\$3.90
BC3	1.7, 3.5, 7.0	±25Kc*	0.03%	Mtd.	4.95
BC3	1.7, 3.5, 7.0	± 5Kc	0.03%	Mtd.	5.75
BC5	1.7, 3.5, 7.0	Exact	0.03%	Mtd.	6.85
BC2	100 Kc Std.	Exact	0.05%**	Mtd.	9.50
BC6	1.7-3.5Mc, or 7 Mc holder for BCX				1.50
	1.7, 3.5 or 7Mc holder-oven for BCX				7.50
SSF	465, 500, or 525Kcs.S.Qtz filter. Mtd.				5.90

\*Or your choice from distributor's stock.  
\*\* Adjustment by purchaser will greatly reduce this.

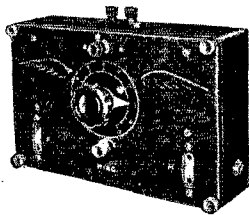

## WING'S TRANSCEIVER

The ideal portable 5-meter job for use in the field, in your car or plane

Built to stand hard use, yet reasonable in weight, only 6 lbs. Unit construction insures sturdy dependability. A cast

aluminum case finished in black wrinkle lacquer and nickel fittings completes the outfit. More and more are going to this new transceiver. Why not try "5" with a "Wing" this summer? You will find a new thrill in portable operation.

Transceiver complete with tested tubes, \$18.25

**Chauncey Wing's Sons**  
Greenfield, Mass.

## Radio Operating Radio Servicing—



Prepare for the new Government Radio Operating license examinations; Radio Operator, Marine and Broadcasting. Also Radio Amateur Telegraph and Telephone. Resident courses.

Write for Booklet

**NEW YORK YMCA SCHOOLS**  
4 West 63rd Street, New York City

## NATIONAL VICTRON

We have in stock National Victron Transposition Blocks. In addition to their low-loss properties, these insulators are light in weight (1/2 oz. each) and almost unbreakable in ordinary use.

Net Price \$ .18 each

Victron is also stocked in sheet form, for experimental use.

Size 1/8" x 12 x 6" . . . . . Net Price \$3.00

Size 3/16" x 12 x 6" . . . . . Net Price \$3.60

National Coil Dope, the so-called "Liquid Victron," used in making low-loss formless coils, as described in March QST, Page 10.

Net Price \$ .90 per can

Watch for the opening of our  
NEW WORCESTER BRANCH

**H. JAPPE COMPANY**  
46 Cornhill Boston, Mass.

# BACK COPIES

OF

# QST

WITH INDEXES

THE LIST given below shows many exceptions, and as time goes on each yearly list becomes more incomplete. You'll be sorry some day if you don't stop, look and ACT now — Right Now!

## HERE THEY ARE

- 1923 — Only May and November issues **\$5.50**  
1924 — Only November and December issues..... **2.50**  
1925 copies (except January, March, May and July)..... **2.00**  
1926 copies — complete..... **2.50**  
1927 copies (except January and July)..... **2.50**  
1928 copies (except January, February, March and August).... **2.00**  
1929 copies (except February, March, April and May)..... **2.00**  
1930 copies (except January, February and July)..... **2.25**  
1931 copies — complete..... **2.50**  
1932 copies — complete (except August, September and October)..... **2.00**  
1933 copies — complete..... **2.50**  
1934 copies — as issued..... **25c ea.**

Complete Set of Copies as Listed **\$15.00**  
Single Copies **25c Each**

ALL PRICES INCLUDE POSTAGE

New binders to keep these files in order are \$1.50 each, postpaid. Each binder holds 12 issues of QST and index, and does not mutilate the copies.

## AMERICAN RADIO RELAY LEAGUE

West Hartford « » Connecticut

the relation of Fig. 10 we find that the transformer efficiency of the coupled tank circuit increases, for a given optimum value of tuned circuit impedance ( $R_o'$ ), as the tuned circuit impedance of the primary alone ( $R_{op}$ ) is increased. This variation is plotted in Fig. 16 as a function of the ratio

$$\frac{R_{op}}{R_o'}$$

It is desirable to have a primary tank impedance ( $R_{op}$ ) without load that is nearly ten times the optimum tuned circuit impedance under load, a transformer efficiency of 90% being obtained for such a condition. This requires that a fairly high  $L-C$  ratio be employed, considerably higher than that for a self-excited oscillator tank. The circuit constants given under Fig. 10 are quite typical for use at 7200 kc. and satisfy this condition. *The tank capacity should be proportionately decreased as the frequency increases.* Thus at 14,000 kc. a 50- $\mu$ fd. tank capacitor would result in the same  $L-C$  ratio as obtained with the tank shown for 7200 kc.

It is sincerely believed that consideration of these basic principles of power amplifier operation and adjustment may prove helpful to the amateur fraternity in explaining some of the relations encountered in practice and thus aid in the securing of superior and more consistent performance from this ideal type of radio transmitter.

### Amateurs of Assistance in Emergencies

(Continued from page 35)

W7ABH, W7ABZ and W6PQ.

Speaking of QRR work, SCM Belliveau, W7AYO, Yakima, Washington, is reminded of an incident which occurred at the time of the Los Angeles earthquake. A lady in Yakima had a son at the Second San Gabriel Dam, in the thick of the disaster. A telegram failing to reach him, she was persuaded by W7DWC to try amateur radio. A message addressed to any amateur in Azusa, Calif. (ten miles from the dam) was sent by W7AYO via his regular California route. The next night W7CAM, Yakima, worked W6EQJ, Azusa, who reported that he had received the message and sent the desired information back to the very much worried mother. Fortunately all was well.

All amateurs cooperating in the several examples of QRR work given here deserve hearty congratulations for their unselfish work, which helps to strengthen Amateur Radio. FB, OMs!  
—E. L. B.

### A Simple Cathode-Ray Oscilloscope

(Continued from page 30)

speech wave will cause overmodulation, clearly visible on the oscillograph, while the meters which measure only the r.m.s. and average values indicate considerably less than 100%. Draw your own conclusions—but believe the osciloscope, not the meters.

Price \$69.50 net,  
(less tubes)

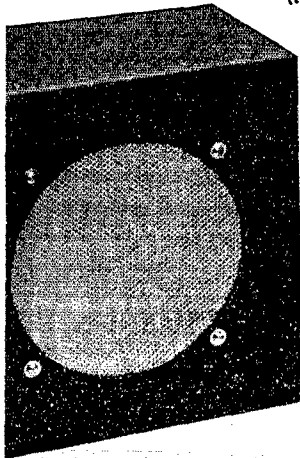

**Extreme Selectivity—No Coils to Plug in—No Extras to Buy!**

You owe it to yourself to own this NEW Ross Jupiter Model — to experience the thrill of a Super-heterodyne receiver cutting through the interference on the amateur frequencies. Set covers four amateur bands by the mere click of a handy switch. Coils are permanently installed and adjusted — no plugging in required. Highest selectivity consistent with full, well-rounded tone. Powerful Wright De Coster dynamic speaker. A quality product.

**HERE'S THE  
AMATEUR  
RECEIVER  
YOU'VE BEEN  
WAITING  
FOR!**

**You Can't Lose!** The NEW ROSS JUPITER comes to you under a guarantee which permits you to return it for full credit within five days if you are not more than pleased. Nothing could be fairer — nothing more convincing as to its quality or outstanding features. Write today for folder.

**A. H. ROSS & COMPANY**  
Keswick Ave. and Waverly Road  
Glenside (Suburb of Phila.) Penna.

## HERE'S A NEW DEAL for the AMATEUR

Now you can buy that new  
RECEIVER OR TRANSMITTER  
on our

### DEFERRED PAYMENT PLAN

Prompt delivery on  
HAMMARLUND COMET PRO  
PATTERSON PR-10  
NATIONAL FB7-FBXA  
COLLINS TRANSMITTERS  
RCA-SYLVANIA-TAYLOR  
Transmitting Tubes  
ROSS JUPITER  
SARGENT 9-33

and all other nationally known lines

WRITE AT ONCE FOR FULL PARTICULARS  
STATING YOUR NEEDS

**DELAWARE RADIO SALES CO.**  
405 Delaware Ave., Wilmington, Del.

Attention: W. S. WILSON — W3DQ  
New York Office — 136 Liberty St., N. Y. C.

## ANNOUNCING a new Midget OVERLOAD RELAY

(with mechanical latch)

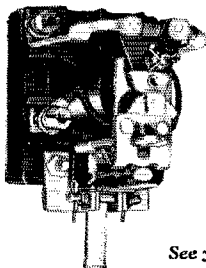
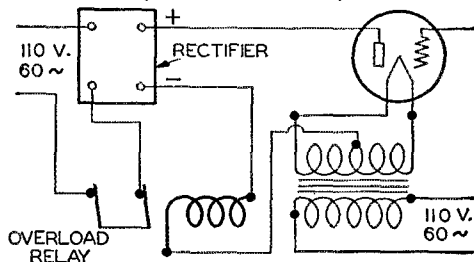

**Transmitter Tube Insurance —**  
You can now tune without that  
sickly feeling that an ever expect-  
ant current surge will burn out  
your valuable tube.

Made in two sizes:

507-512 — 250 Ma.

507-513 — 500 Ma.

Price \$8.50

See your dealer or write the factory

**WARD LEONARD ELECTRIC CO.**  
Mount Vernon, N. Y.

# COMMERCIAL RADIO

20  
CENTS

## DO YOU KNOW?

*What is going on in the Airway field of radio?*

*What the latest developments in the experimental labs. are?*

*What the latest equipment is in the big broadcast stations?*

*What the activities of the men behind the transmitters are?*

*The design of the larger Foreign transmitters?*

The requirements for a Commercial Ticket; what The I. B. E. W. is; The news of The American Radio Telegraphists Association; The enterprises of the Veteran Wireless Operators, Ship News; Broadcast Station News; Advanced Technical articles; Police Transmitters.

*If you read "Commercial Radio" You Will Find All of This and More.*

A real professional radio operators magazine — the only one of the kind published in America. Subscription price \$2.00 a year. Published Monthly.

### COMMERCIAL RADIO

112 West 13th St. New York City

## GULF RADIO SCHOOL

Radiotelegraphy

Radiotelephony

Radio Servicing

SECOND PORT } 1007 Carondelet Street  
U. S. A. } NEW ORLEANS, LA.

## FASTEST WAY TO LEARN CODE

Easy, Fascinating.

LEARN BY EAR

to be a Good Op!

The New MASTER TELEPLEX Code Teaching Machine is exactly what thousands are looking for. Has taught code to more operators in past 10 years than all other "systems" combined. No experience needed. Ideal for beginners — steps up w.p.m. for all ops. Teleplex doesn't merely "show" you code — it IS code! You actually HEAR the dots and dashes, any speed you want. You learn code the way you'll be using it — by SOUND! Teleplex also sends back to you; impossible with any other system. Complete Code Course included; no extra charge. Used by U. S. Army, Navy, R. C. A., A. T. & T. Co., and others. Low cost, easy terms, Money-Back-Guarantee. Send now for booklet Q-16; no obligation. Postcard will do.

FREE  
BOOK

TELEPLEX COMPANY

76 Cortlandt Street

New York, N. Y.

## More on Overmodulation

(Continued from page 21)

course I am unable to determine with the oscillograph whether they are positive or negative peaks. The remaining six amateur 'phones averaged 10 to 12 percent deviation in modulating their positive and negative peaks and in no case did I find an absolutely symmetrical wave.

"In all of the 19 cases, when the percentage of modulation was reduced to below 100 percent a general improvement was immediately apparent in the quality and also in the symmetrical appearance of the positive and negative peaks; and in some cases it was possible, by readjustment of the transmitter (particularly the retuning of all stages and adjustment of the  $L/C$  ratio in the tank circuits and couplings in antenna circuits) to improve the symmetrical appearance of the modulated carrier.

"Since the appearance of the article on overmodulation and the checking of the 19 stations above mentioned, I have noticed a big improvement in the general conditions on the 75-meter band. Those stations which ordinarily, due to overmodulation, have each occupied approximately one quarter of the 'phone band have reduced their spread remarkably well. I have also found that the quality is much better and that there is a general improvement in the stability. I have rechecked all nine of the readjusted stations and have found in all nine cases that these stations are maintaining their modulation under 100 percent. In three cases I have had direct reports, through contacts, that they are having better results in the general operation of their transmitters.

"I am under the impression, in view of discovering so many amateurs using the r.f. galvanometer method of determining the percentage of modulation, that through improper use of the galvanometer they are bound to overmodulate. The galvanometer having four elements in it and being very delicate, it is very easy to burn out any one of these elements and thereby throw out the general accuracy. Also, because of the slow action the galvanometer isn't able to follow the voice quickly enough without the use of a sustaining note. This is probably one of the reasons for the overmodulation, particularly with Class-B operation."

—W8KIR

Several correspondents raise theoretical questions as to the accuracy of the overmodulation percentages cited in the December article, although no particular claim to accuracy was made and the figures given were intended to be only approximately indicative. In this connection it should be explained that the method of using the superhet receiver's second detector as a v.t. voltmeter was first proved by running a calibration curve of detector a.c. grid voltage vs. plate current and by testing the monitoring receiver on a laboratory transmitter set-up. Simultaneous

# Amateur Headquarters • "Everything for the Ham"

## High Quality Delta

### Transformers

at prices of the ORDINARY.

Ad 70 & Ad 71 for 203  
A's Class B.  
Per pair \$26.55

Ad 75 & 76 for RK  
18's Class B.  
Per pair \$13.80  
Ad 76 & Ad 77 for  
800's Class B.  
Per pair \$13.80

Secondary of above out-  
put units will carry  
class-C amp. current.

We carry a complete  
stock of DELTA Units.  
Send for Bulletin DL  
48.

## YOUR LAST CHANCE FOR THIS FAMOUS BARGAIN

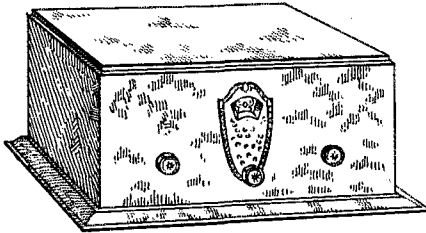

## NATIONAL \$19.75 SW 45 Sets

AT OUR SPECIAL PRICE (less tubes and coils)  
A 5-tube, Tuned R.F. Set, using two Type 35, one 27  
and two 45 Tubes.

Coils available from 9 to 2000 meters. Short Wave  
and Band Spread Coils, \$3 per pair.

Complete Set R.C.A. Tubes.....\$2.80  
Special M. & H. Power Pack.....\$9.95

### Combination Price RECEIVER & POWER PACK

Less Tubes and Coils, this month only.....\$27.95

Continued by popular  
request

## M. & H. Power Pack

For National FB7A, FBXA

High Quality Unit \$9.95

R.C.A. Type 80  
Rectifier Tube, 40c  
extra

### New Sprague Oil Transmuting Condensers

2 mfd. 1000 V.....\$2.65  
4 mfd. 1000 V.....\$4.12  
2 mfd. 2000 V.....\$4.80

### Hoyst Hot Wire Ammeters \$3.25

Each  
0-1.5 Amps.  
0-3 Amps.  
0-5 Amps.  
In stock at all times

512 Market St. **M. & H.** Philadelphia, Pa.

Radio Specialists

Sporting Goods Co.

Send for New 1934 Catalog

**"GO-DEVIL"** VELVET SMOOTH ACTION  
AUTOMATIC KEY Pure tungsten contacts, heavy  
Highest quality, low- non-skid base, beautiful  
est price. Equally appearance, rugged  
suitable for beginners construction.  
— or old timers. Shipped Guaranteed  
by return mail. \$6.00

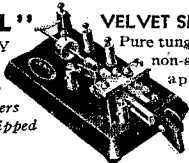

A. H. EMERY 263 MILL ST. POUGHKEEPSIE, N. Y.

**LEARN RADIO** New Classes Now  
Forming! Send for  
40-page catalog, ex-  
plains fully. 180 licensed graduates placed in past 2½ years in  
broadcasting, shipping, police radio, aviation, etc. We teach all  
branches. Oldest, largest and best equipped school in New Eng-  
land. Equipped with Western Electric sound and broadcasting  
equipment and RCA marine transmitter. Course prepares for  
United States Government telegraph or telephone license.

MASS. RADIO SCHOOL, 18 Boylston Street, BOSTON

## PRECISION CRYSTALS

(FOR ACCURATE FREQUENCY CONTROL)



Crystal Holder—\$1.50

More power—better frequency control  
with PRECISION crystals. We guaran-  
tee our crystals to be the finest quality  
obtainable. They are used by leading  
radio men everywhere.

These crystals are X cut, one inch  
square, accurately ground for maximum  
output and thoroughly tested. They are  
accurately calibrated and will be re-  
sponding within 0.1% of your specified fre-  
quency. It will pay you to buy these  
quality crystals. 1750 kc. bands—\$3.90 ea. 7000 kc. band  
—\$4.90. Furnished with holder—1750 and 3500 kc. \$4.50 ea.  
7000 kc.—\$5.50. Jacks to plug holder into—15c pair.

Crystals and ovens for commercial use quoted on at your request.  
Now in our 5th year of business.

### PRECISION PIEZO SERVICE

427 ASIA STREET

BATON ROUGE, LA.

## HERE IT IS!



### THE NEW

## Type TD Transmitting Condenser

A brand new development in paper condenser impregnation . . . the  
result of four years of intensive research and critical experimentation  
. . . now made available for radio ham transmitters at radio-ham-  
pocketbook prices.

- Extreme compactness—1/8th size of corresponding units with ordinary impregnation.
- Highly efficient due to new impregnation and selected paper.
- Superior characteristics— notably greater dielectric strength, lower losses, better filtering.
- Extra conservative voltage ratings: extraordinary long life.
- Equipped with highly glazed porcelain insulator terminals.
- Available in 1, 2 and 4 mfd. capacities: 600 1000, 1500 and 2000 volts D.C.

Write for data on this money-saving, space-saving, temper-  
ature-stable type capacitor. Also for the new C-D 1934 catalog,  
or better still, get the "dope" from your supplier.

### CORNELL-DUBILIER CORPORATION

JOBBER'S DIVISION

4373 Bronx Blvd.

New York City



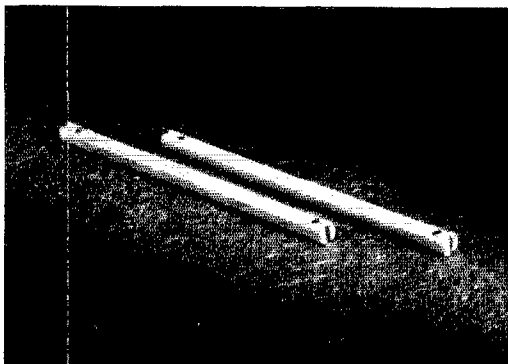

**SPREADER:** Light in weight as well as exceptionally efficient, these Steatite spreaders offer unusual advantages. The material is non-hydroscopic and weatherproof. The slender shape minimizes surface leakage. The power factor is of the order of 0.15%. The weight is but one ounce each. Catalog Symbol AA-3.

List Price \$ .30

Usual Discounts apply

**NATIONAL COMPANY, INC.**  
MALDEN, MASS.

# R A D I O

**ENGINEERING,** broadcasting, aviation and radio telegraphy and telephony, police radio, servicing, marine accounting taught thoroughly. Engineering course of nine months duration equivalent to three years of college radio work. School established 1874. All expenses low. Catalog free. DODGE'S INSTITUTE, Day Street, Valparaiso, Indiana

## "THREE LITTLE PIGS"



\* No method is known of estimating dielectric hysteresis losses with any degree of accuracy. To reduce insulator losses the best type of insulation should be used. Subject to mechanical requirements, the insulator should be as long as possible and the cross section as small as possible to minimize leakage and reduce local capacity at the points of attachment to transmission poles.

\* Statement of T. WALMSLEY, B.Sc.  
BEAM ARRAYS AND TRANSMISSION LINES  
**The Institution of Electrical Engineers.**  
(of London)

Greater strength with better electrical efficiency; lower cost with less wind resistance may be had in your antenna if you use LYNCH NAVY STANDARD INSULATORS IN SERIES, FOR YOUR TRANSMITTING AND RECEIVING DOUBLETS.

Technical bulletin on practical ham antenna and transmission-line design on request

**LYNCH RADIO LABORATORIES, INC.**  
51 Vesey St. New York, N. Y.

cathode-ray oscilloscope measurements showed that appreciable increment of detector average plate current occurred invariably at the point where the oscillograph showed overmodulation (carrier shift); and that, at least to the limit of several hundred percent modulation, agreement between oscilloscope amplitude readings and proportional increment in average plate current was sufficiently close for practical purposes. Other checks showed no detectible indication of the percentage modulation rise anticipated as a possible contribution of receiver r.f. circuits preceding the second detector. It is of incidental interest that in these tests positive peak modulation percentages in excess of 1000 percent were obtained by suitable mal-adjustment of the test transmitter set-up, these extreme percentages giving an oscilloscope picture not unlike a picket fence in appearance. On the basis of these tests the average plate current variation method of preventive checking (either in a suitable detector or in a transmitter amplifier handling modulated r.f.) is recommended as the simplest practical known at the present time. It should be unnecessary to point out that such receiver checks should be made only on suitably strong signals free of interference and fading.

Another question brought up was whether it is possible for an amateur transmitter to modulate as much as several hundred percent, the instance being given of a transmitter having a plate modulator rated at 50 watts and a Class-C amplifier operating with a mean plate input of 100 watts, for normal 100-percent modulation capability, requiring four times the power for 200 percent modulation, and so on. Now the 'phone transmitter operating with 100-percent increase in effective antenna current under modulation, representing quadrupling of the average power output, is not as rare as it should be. It must be realized that the normal modulator rating is for negligible distortion and for average power over a considerable period of time. The average distorted power output under abnormal conditions, however, may be considerably greater than this rating, as is well known, and the peak power during transients of short duration can be still greater. Just as a power-plant generator can deliver many times its normal (continuous-rating) power output during a transient load condition, so can the modulator (which is essentially an audio-frequency power generator) under the transient conditions of speech overmodulation. As was stated in the December article, it's these transients that we must worry about.

The coöperation of the 'phone gang in clearing up this overmodulation condition has produced a remarkable improvement. By continuing to be honestly critical of our signals, a great deal more that remains to be done can be accomplished. Careful and continuous checking of our own signals, honest reports on the other fellow's and a friendly spirit of give-and-take will do the trick.

—J. J. I.

# WEAR THE EMBLEM

FOR A.R.R.L. MEMBERS ONLY



USE  
MEMBERSHIP  
STATIONERY



Write your radio letters on League stationery. Lithographed on 8 1/2 x 11 heavy bond paper. Postpaid. 100 sheets, 50c; 250 sheets, \$1.00; 500 sheets, \$1.75.

American Radio Relay League  
West Hartford, Connecticut

The League Emblem, in heavy rolled gold and black enamel, either pin or button. Special colors available for Communications Department appointees. Red background for the SCM, green background for the RM, blue background for the ORS. Red and green colors available in pin type only, blue available both in pin and button types. Price only \$1 post-paid.

**SHIELD CANS!!!**  
Black shrivel finish on quality steel. BUY NOW while prices are still LOW.

Length	Height	Width	Price
5"	5"	5"	\$.59
6"	5"	6"	.65
9"	5"	9"	1.10
9"	6"	9"	1.10
8"	6"	6"	1.05
9"	7"	8"	1.20
10"	7"	9"	1.29
10"	8"	8"	1.38
14"	8"	10"	1.69
18"	9"	8"	2.59
19"	10"	12"	2.95

National new "experimenter" type midget condenser, 100 mmf. .... \$ .60  
Blank chassis — cadmium plated — all sizes stocked.  
Distributors for Acme-Delta, Collins, Cardwell, National, Hammarlund, etc. Write for prices, Free bulletin. 20% deposit with all C. O. D. orders. Include postage. Remit by M. O.

**MAURICE SCHWARTZ & SON**

710-712 Broadway Schenectady, N. Y.

**GUARANTEED**  
**5 YEARS**



**DELTA**

Class B 800's  
or any 100 watt audio —

INPUT..... \$4.50  
OUTPUT..... 9.30

Other DELTA 5-year guaranteed parts in stock

**NATIONAL PRE-SELECTOR**

for FB7's  
\$11.40 net

Coils, FBXA's, etc.  
Full National Line

**COMET**

CRYSTAL PRO \$106.95

**HAMS** Hear More DX  
with TRIMM  
24,000 ohm Impedance



**Featherweight Phones**

The iron being operated near the saturation point in these phones, extra loud signals and static crashes are damped, while the exceptionally high impedance at frequencies above the ordinary voice and music range, reduces to a minimum background noises, weak signals become prominent.

**TRIMM RADIO MFG. CO.**

1528 Armitage Ave.

Chicago, Ill.

**HATRY & YOUNG**

203 Ann Street

Hartford, Conn.

The new  
RADIOHM  
did the  
trick

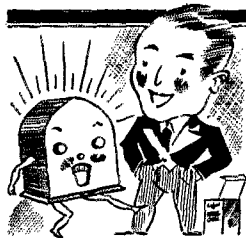

**S**ERVICEMEN are "sitting pretty" since the new Radiohm was made available for replacements. Now even smoother performance is made possible while the control itself is made smaller. Stock up now . . . with the serviceman's best friend.

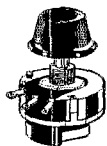

The new 1934 Centralab Volume Control Guide now ready for you. Ask your jobber for your free copy.

**CENTRAL RADIO LABORATORIES**  
Milwaukee, Wisconsin

New!

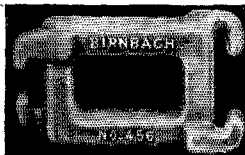

### BIRNBACH ANTENNA TRANSPPOSITION BLOCK

Increases efficiency of doublet antennas. Strong, glazed, high-resistance ceramic. Rounded edges protect wire. Hooks prevent slipping and twisting of feedline. Write Dept. O-4 for complete details of modern short-wave antenna accessories.

**BIRNBACH RADIO CO., INC.**  
145 Hudson Street New York City

## Highest Quality Crystals

Unconditionally guaranteed. Cut by modern optical methods and parallelism of surfaces and their orientations with respect to crystallographic axes are held to better than .5 degree.

160-80 meter Amateur bands within 10 KC. . . . \$3.50  
40 meter Amateur band within 10 KC. . . . . 4.50  
Finished blanks for 160-80 or 40 meters. . . . . 1.50  
465-500 or 525 SS quartz filters. . . . . 5.00

See page 91 Feb. 1934 *QST* for complete price list

**Bellefonte Radio Eng. Lab.**  
BELLEFONTE, PENNA.

## Amateur Radio Stations

(Continued from page 41)

are on the left of the transmitter. The antenna tuning unit behind the transmitter consists of an aerial ammeter and three high capacity variable condensers. One of these condensers is coupled to a coil and connected to the feeder of the Hertz antenna, and is used as an 80-meter harmonic suppressor when operating on the 160-meter band. (Page 45, January *QST*.)

VE2HM has been in active operation for only a few months, and work has been mostly restricted to 160-meter 'phone. So far five districts in the U. S. A. and three Canadian districts have been worked on this band, with very good reports in the majority of cases. The station is also equipped to operate on 80 and 20 meters c.w. though comparatively little serious work has been attempted on those bands to date.

## The Oklahoma State Convention

(West Gulf Division)

**W**ITH delegates from 10 cities in Kansas, 3 cities in Missouri, 17 cities in Oklahoma and 3 cities in Texas this first convention, sponsored by the Key Clickers of Ponca City, Okla., at the Hotel Jens Marie, January 20-21 started auspiciously, notwithstanding the mist and fog which made driving hazardous. The careful planning of the affair under the chairmanship of Bob Miles, W5CIZ, resulted in a program that left nothing to be desired. The cordial greetings extended the delegates by Lester Barnes, W5ABK, president of the Club made every one feel at home. Director Frank M. Corlett, of the West Gulf Division, was the principal speaker of the convention. He covered the Madrid Treaty and the mooted points on "International Message Handling."

Numerous contests were held and fifteen minutes of entertainment by Bennie Martin, a local comedian and entertainer, was enjoyed by all. "The Cleveland Air Races," a film loaned by A.R.R.L. was shown, followed by a "Mickey Mouse" film. The key-note of the convention was entertainment. While the YL's, exYL's and OW's were at the Murray Theatre enjoying a midnight preview, the OM's adjourned to the Indian Hills Clubhouse, several miles from town to participate in a stag party. From all indications every one had a rousing time, and it would be superfluous to go into details, and we will only say that every one got back to town in time for breakfast.

A general business session was held in the auditorium of the Senior High School on Sunday morning with Carter L. Simpson, W5CEZ, in charge. At this meeting discussion of plans for future meetings and reports from various clubs represented took place. The following clubs reported: The Walnut Valley Radio Club;



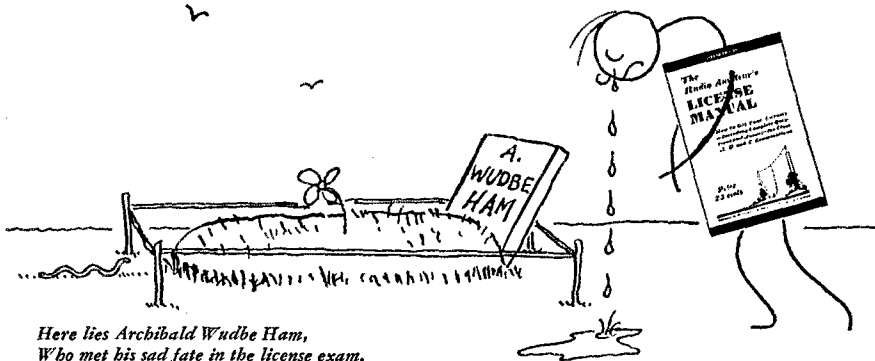

Here lies Archibald Wudbe Ham,  
 Who met his sad fate in the license exam.  
 The guy with the weeps at the right of the picket  
 If consulted by Arch would've got him his ticket.

## THE RADIO AMATEUR'S LICENSE MANUAL

25c, postpaid; no stamps, please

A necessity for the beginner — equally indispensable for the already licensed amateur. Going after your first ham "ticket"? You need the manual for its instructions on where to apply, how to go about it in the right way — and, most important of all, for the nearly 200 typical license exam questions and answers. Already got a license? The manual is still necessary — for its dope on renewal and modifica-

tion procedure, the Class A exam (with questions and answers), portable procedure, etc.

All the dope on every phase of amateur licensing procedure, and, of course, the complete text of the new regulations and pertinent extracts from the basic radio law.

Get a copy of "The Radio Amateur's License Manual" and be sure to get your ticket.

(No. 9 in the series entitled The Radio Amateur's Library)

THE AMERICAN RADIO RELAY LEAGUE, WEST HARTFORD, CONN.

## LOW RANGE FUSES

- Littelfuses for Instruments: Amps.: 1/100, 1/32, 1/16—20c ea. 1/8, 1/4, 3/8, 1/2—15c ea. 1, 2—10c ea. For milliammeters, ham rectifiers, etc. Use 1/8 for radio B circuits. High Voltage
- Littelfuses: 1000, 5000, 10,000 volt ranges in 1/16, 1/8, 1/4, 3/8, 1/2, 3/4, 1, 1 1/2, 2 amps. Renewable. Price 35c to \$1.25 ea. NOW—\$100 PROTECTION GUARANTY. Get New Cat. #5.
- LITTELFUSE LABS. 1784 Wilson Ave., Chicago

*"Quicker than a Short circuit"*  
**LITTELFUSES**

## RADIO ENGINEERING

RCA Institutes offers a combined course of high standard embracing all phases of Radio. Practical training with modern equipment at New York and Chicago schools. Also specialized courses and Home Study Courses under new "No obligation" plan. Illustrated catalog on request

**RCA INSTITUTES, INC. Dept. ST-4**  
 75 Varick St., New York. 1154 Merchandise Mart, Chicago  
 Recognized Standard in Radio Instruction Since 1909

## CQ-AMATEURS of the West

Just off the Press, send for your copy

### 1934 CATALOG

All Nationally advertised parts  
 for Transmitting and Receiving  
 Lowest Prices

### RADIO SUPPLY CO.

H. A. DEMAREST, President

912-14 So. Broadway Los Angeles, Calif.  
 (W6FBI, located in Building)

## Don't Worry About That Exam!

### CANDLER SYSTEM WILL MAKE IT EASY FOR YOU

The better class Amateur and Com'l op will tell you CANDLER Specialized Training in Code Fundamentals is as necessary to Skill, Speed, and Accuracy as is a knowledge of Ohm's Law to an understanding of electricity.

PRACTICE is important. Knowing how to practice, as taught by CANDLER, is more important. Any skilled op will tell you he did not learn code by listening, alone, to a practice set. He had to learn HOW!

"As Radio Champion for 13 years, official speed 56 1/2 w.p.m., and as holder of all-time American Morse speed record, 70 w.p.m., I had no other training except CANDLER Advanced and 'MII' Courses." T. R. McElroy, 23 Bayside St., Boston.

"Candler Advanced and 'MII' Courses enabled me to pass rigid, competitive test for this position." Richard D. Watson, WHEW, Byrd Expedition.

"CANDLER SCIENTIFIC CODE COURSE made it possible for me to win official Radio Championship in Class 'E'." Jean Judson, W3BAK.

The best code practice is on the air. It costs you nothing. We tell you where to listen for CSCG Skeds., and show you how to develop your speed and technique quickly and easily by our original method.

Send for FREE Book of Facts today. It tells the whole story and gives you valuable information.

**CANDLER SYSTEM CO.**  
 Dept. Q-4 6343 S. Kedzie Avenue, Chicago





**NEW**

**3 5 4  
GAMMATRON**

*A Real*  
**TRANSMITTING  
TUBE**

•  
**Rated Output  
100 WATTS**

•  
*Write for Folder*

**HEINTZ AND KAUFMAN**  
LTD  
Engrs.—Mfrs.

**SINCE 1919**  
311 Calif. St.

**SAN FRANCISCO, Cal.**

Wichita Radio Club; Enid Radio Club and the Tulsa Amateur Radio Club.

Mr. R. T. Woodruff, Commander of Oklahoma Section, U.S.N.R., gave a very interesting talk on the Naval Communication Reserve; its purpose and general activities. The Army-Amateur Network was well covered by Carter Simpson of Oklahoma State Net Control Station.

The prize to the ham coming from the greatest distance was awarded to W5DUR (Mrs. "Soupy" Groves) from Neches, Texas. It is interesting to note that two YL operators, besides Mrs. Groves were present, each operating their own stations: Miss Opal Sisk, W9CMV, Pittsburg, Kans., and Miss Letha Allendorf, W9OUD, Joplin, Mo.

One of the good talks of the convention was that of Mr. Guy E. Wilson, W9EL, technician of Radio Laboratories of Kansas City, Mo., and his demonstration of three stations all on 'phone and on three different bands was most convincing of what can be accomplished with proper and modern equipment.

The closing event was the banquet held at Harry's café and the awarding of prizes, with a satisfied feeling of all that the committee had done a first class job.

—C. L. S.

### How to Get Those Foreign QSL's

*(Continued from page 36)*

Each of the QSL Managers reports that he has on hand many dozens of cards for fellows who haven't sent in envelopes—frequently after they have been advised cards are on hand for them. Moral: Send your QSL Manager an envelope. Send it even if you haven't worked any foreigners; because of more severe restrictions abroad, lots of foreign amateurs have receivers only, and spend their time listening and logging American signals. You may not have worked a single foreigner, and still have half a dozen foreign cards on hand for you to prove that you "got across."

Coöperate by remembering postage, the printing of your call in the upper left-hand corner, and the use of a No. 8 envelope. Many, according to the already hard-worked managers, are forgetting one or another of these, and they make a heck of a lot of difference to the fellow who is giving you a lot of his time, and who has plenty of grief without having to fish in his own pocket for postage, or look up your call in the callbook, etc.

And lastly, take time occasionally to originate a message or drop a postcard to your QSL Manager with a word of cheer; his work is purely voluntary, involves no remuneration, and gets him nothing more than the satisfaction of knowing he is performing a worthwhile service to his fellow hams.

—A. L. B.

It Cost us  
**\$17,000.00**

to produce—  
and it's yours for

**\$1.00**

POSTPAID ANYWHERE

**See the Second Cover**

A.R.R.L.  
38 LaSalle Rd., West Hartford, Conn.

Here's my dollar. Send me mine.

.....  
(Name)

.....  
(Street or Box)

.....  
(City and State)

# HERE'S HOW TO BECOME A RADIO AMATEUR

32 pages clearly written tell how to build the first receiver, a simple transmitter, an inexpensive monitor. You'll find a complete discussion of all the problems of the beginning amateur—all in 1934 style, up-to-the-minute and understandable—in "How to Become a Radio Amateur".

"How to Become a Radio Amateur" (No. 8 in the A.R.R.L. Series entitled "The Radio Amateur's Library") is the standard elementary guide for the would-be amateur. 25c (no stamps, please) postpaid anywhere.

THE AMERICAN RADIO RELAY LEAGUE  
WEST HARTFORD CONNECTICUT



**KLAUS RADIO & ELECTRIC CO.**  
707 MAIN STREET PEORIA, ILLINOIS

**RADIOTRONS**—Transmitting and Receiving  
Standard Lines of RECEIVERS and PARTS  
WRITE FOR LITERATURE

University Course in  
**RADIO COMMUNICATION**

Open to high school graduates. Complete in nine months. High standard of instruction and equipment. Fall term opens September 14.

UNIVERSITY OF WISCONSIN—Extension Division  
623 West State Street Milwaukee, Wisconsin

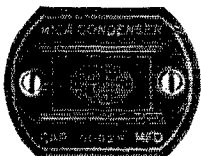

**SANGAMO  
ACCURATE  
CONDENSERS**

Available in 5000 volt construction  
for use in short wave transmitters

Write for catalog sheet

**SANGAMO ELECTRIC CO.**  
SPRINGFIELD, ILLINOIS

## CONVERTIBLE VOLUME CONTROL

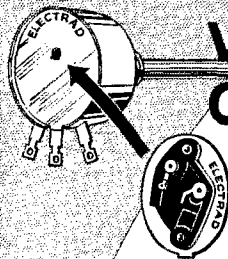

*Used with  
or without  
Power Switch*

THE ideal replacement volume control because of these distinctive advantages:

- 1 — Interchangeable end cover permits the use of a power-switch without disturbing control connections.
- 2 — Long ALUMINUM shaft, easily cut to desired length.
- 3 — Only five types required to service 799 standard receiver models.

Write Dept.  
Q-4 for  
FREE Catalog  
and Vest-  
Pocket Vol-  
ume Control  
Guide.



# HAM-ADS

(1) Advertising shall pertain to radio and shall be of nature of interest to radio amateurs or experimenters in their pursuit of the art.

(2) No display of any character will be accepted, nor can any special typographical arrangement, such as all or part capital letters be used which would tend to make one advertisement stand out from the others.

(3) The Ham-Ad rate is 15c per word, except as noted in paragraph (6) below.

(4) Remittance in full must accompany copy. No cash or contract discount or agency commission will be allowed.

(5) Closing date for Ham-Ads is the 25th of the second month preceding publication date.

(6) A special rate of 7c per word will apply to advertising which, in our judgment, is obviously non-commercial in nature and is placed and signed by a member of the American Radio Relay League. Thus, advertising of bona fide surplus equipment owned, used and for sale by an individual or apparatus offered for exchange or advertising inquiring for special equipment, if by a member of the American Radio Relay League takes the 7c rate. An attempt to deal in apparatus in quantity for profit, even if by an individual, is commercial and takes the 15c rate. Provisions of paragraph (1), (2), (4) and (5) apply to all advertising in this column regardless of which rate may apply.

Having made no investigation of the advertisers in the classified columns, the publishers of *QST* are unable to vouch for their integrity or for the grade or character of the products advertised.

OVER six pounds radio data, circuits, bulletins, 50¢ postpaid. Beyond Rockies 75¢. Kladag, Kent, Ohio.

MICROPHONE and meter repairs. Low prices. Quick service. Sound Engineering Corp., 416 N. Leavitt St., Chicago, Ill.

RADIO engineering, broadcasting, aviation and police radio, servicing, marine and Morse telegraphy taught thoroughly. All expenses low. Catalog free. Dodge's Institute, Byrd St., Valparaiso, Ind.

QUARTZ—Direct importers from Brazil of best quality pure quartz suitable for making piezo-electric crystals. Diamond Drill Carbon Co., 719 World Bldg., New York.

HAMMARLUND "Comet Pro" receiver, nearly new, complete with tubes and coils for 9 to 55 meters. D.C. model. Only \$58.50. H. C. Wing, Greenfield, Mass.

QSLs! QSLs! Variety! "World's Finest QSL Cards!" Samples?? Sell Callbooks, Handbooks, W8DED, Holland, Mich.

METERS repaired properly at reasonable rates. Electrical Instrument Labs., 1542 Hertel Ave., Buffalo, N. Y.

TRANSMITTER for sale—200 watt output, rack and panel commercial job, four stage crystal control, with separate power packs, 852 final. Complete with 10 tubes. Stamp for fotos. Francis Smitz, W9NRB, 429 N. Central Ave., Chicago, Ill.

QSL cards, two color, cartoons, message blanks, stationery, snappy service. Write for free samples to-day. W1BEF, 16 Stockbridge Ave., Lowell, Mass.

PHOTO stamps. Lickem, stickem. Makes photo QSL of any card. 3 cent stamp brings samples. W8KVY, 441 Prospect St., Muskegon, Mich.

SELL equipment cheap. Write for list. W2BZB.

NATIONAL receivers, big line new and used parts. Swaps. Xray or tubes offered for anything I need. W9DOQ, Route 1, Duluth, Minn.

CRYSTALS \$1.35. Hipower oscillators 3500-1700 KC. Bands close to your specified frequency. 7000 Kc. Band \$4.25. Plug-in holders with mounting, \$1.00. Blanks 65¢. Immediate delivery. Send for complete price list and bulletin. Hipower Crystal Co., 3607 N. Luna Ave., Chicago, Ill. You Cannot buy a better crystal than Hipower at any price.

QSLs, two colors. Samples. Printer, Corwith, Iowa.

GUSTOM built transformers—% KVA, all normal voltages, 45 lbs. cased, \$12.50, uncased, \$10.50. 45 lb. cased chokes, \$11.50, uncased, \$9.75. Mike, line transformers, cast-iron-cased \$2. Baker Eng. Labs., Fort Wayne, Ind.

5 Kilowatt water cooled tube with jacket, hose reel, solenoid valve, excellent condition, \$75. 2-G. E. 1 1/2 Kw. Air cooled transformers, 110/1600 or 3200 V. each side c.t. \$15 each. Teleplex with 13 tapes slightly used \$13. 500 V. 200 Ma. MG set \$12. 18 V. 18 A. two bearing MG with rheostat, \$15. G.E. vapor-proof magnetic switch 30A. 110 or 220 V. with push button and overload relays \$10. Several other relays on hand. Want: 204A, 849, several 3 1/4" Weston bakelite cased instruments. W4AAD Kingsport, Tenn.

SW3 complete with tubes and 4 sets coils, like new, \$15. National Velvet Power Pack complete with tube, \$15. Baird 7 tube SW receiver complete with tubes, \$20. Harvey T. Moore, Box 98, Alstead, N. H.

SELL Hammarlund Pro complete with tubes and 6 pair of coils. \$60. W1CWP.

VIBROPLEXES and speed bugs. Latest models, \$11. Trade-ins accepted. Lydeard, 28 Circuit St., Roxbury, Mass.

CLASS B transformers—for 46's \$4.95 pair. Universal Transformers for two or four 46's, 210's, 800's, RK18's, etc. \$7.75 pair. 70 watts of audio from 46's. Write for details. W8UD, Douglas, Michigan.

203A fifty watters, \$9.75 each. New, first quality and fully guaranteed. Also 211s and 845s. VTE Labs., Ridgefield, N. J.

QSLs, 75¢ a 100. 2 colors. W9DGH, 1816 5th Ave. N., Minneapolis, Minn.

WILL trade 50-watters for stamp collection. W4BUT.

FB7s, Teleplexes, Omnigraders, Vibroplexes, meters, receivers, converters. Bought, sold, traded. Ryan Radio Co., Hannibal, Mo.

QSLs by Maleco. Finest in country. Free samples. Maleco, 1512 Eastern Parkway, Brooklyn, N. Y.

FOR sale—FB7 coils, \$4. p.p. 250 15 watt amplifier, \$20, condenser mike, 3 stages in head, \$15, Comet Pro, 1st model, new air intermediates, \$60. Bargains. W2HY.

QSLs 50¢ per 100. Samples, 2143 Indiana Ave., Columbus, Ohio.

SELL—Silver 5B. Cash. Best offer. W9ISA.

1500 watt 115 volt Kohler automatic electric plant. Recently overhauled. New starting batteries. Sell or trade for complete crystal fone. c.w. transmitter. W2GOT, 117-19 168 St., Jamaica, N. Y.

CRYSTALS, guaranteed. 160-80 meter, 3/4 to 1", within 15 kilocycles, plus or minus, \$1.35. 1", within 5 kilocycles, \$2.50. Hundred kilocycle bar, \$5. e.o.d. William Threm, W8FN, 4021 Davis Ave., Cheviot, Ohio.

CRYSTALS. 160-80 meter. Will trade for what have you? Uptown Radio, 1833 Elm St., Cincinnati, Ohio.

IMMEDIATE shipment—lowest prices: All National, Hammarlund, Paterson, McMurdo-Silver receivers. Trade-in your receiver. In stock: National, Hammarlund, McMurdo-Silver, Cardwell, Thordarson, Triplett, Westun, Universal, Johnson, Biley, Supreme, other apparatus. Piezo-Astatic microphones \$12.25, guaranteed 866s \$1.95. Teleplexes rented. Write. Henry's Radio Shop, Butler, Mo.

CRYSTALS: 1" power X cut within 2 kcs., \$2. Special holder, 95¢. Biley holders, \$1.50. W8DLM, Rochester, Mich.

SELL or trade—RCA course, code machine. Electrical Engineering course. H. Dobrovolsky, Bonner, Mont.

SELL April '33 super \$25. Want parts, meters. W9ERU.

GET my QSL proposition first. Jake, Specialty Printer, Franklin, Penna.

POWER equipment to engineer your station for maximum antenna watts. Relay racks to increase transmitter efficiency, conserve station space, give it that prized commercial touch. Edison battery headquarters. See January display. Rectifier Engineering Service.

CRYSTALS: 160-80 meters, approximate frequency 1", \$1; 40 meters \$2. Guaranteed. W8EBV, Muskegon, Mich.

900W Thordarson 1000, 1500 each side, \$3.50. W9CP.

TRANSFORMERS—400 Watt. 1250-1000-750-0-750-1000-1250, 300 ma. Mounted. Terminal board. 7 1/2 x 8 1/2 x 4, 321 lbs., \$7.50; 600-0-600, 300ma, \$5.00; 30H, 85ma chokes, 35¢. Wanted Silicon steel. Spear Company, Waterville, Ohio.

QSLs, two color! 50¢ up! Stationery! Snappy service! W9ECI, Clayton, Mo.

CRYSTALS, \$1.35. Holder, \$1. W9ECI.

HAYWIRE transmitters rebuilt at moderate prices. Holmes C. Miller, Box 105, Palo Alto, California.

HEAVY duty mesh filament 866s, \$2.50. 872s, \$7.50. 212Ds, \$10. Late type Universal S-G quarters, \$15. 849s, 204As, etc. Westinghouse 5000V, 2.75 mf. oil condensers, \$15. 849A prime oil xfmrs with 8000-16000 ohm output, \$25. Ewing, 1057 Pratt Blvd., Chicago.

KENYON B31 audio transformers, \$2. 45 in stock. W1AIZ, 37 Paul Gore, Jamaica Plain, Mass.

CRYSTALS: Guaranteed excellent oscillators, 160 or 80 meters, your approximate frequency \$1.35 postpaid. Crystal Maker's Blanks 1" 65¢-dozen \$6.00. Irregular shapes 25¢. Improved dust-proof Bakelite Holders, 1 1/4" silvered electrodes increase efficiency, plugs into G.R. or tube socket mounting, any position, no exposed electrodes, 75¢-dozen \$5.40. Fisher Laboratory, 1200 E. Nevada, El Paso, Texas.

CRYSTALS: Remember, if you want the best, order a Smith-Precision specially ground X cut power plate from W6BCX.

"MARINE" crystals—best by test—40, 80, 160 band—stock, approximate frequency \$2.45; 80, 160 band, specified frequency \$3.45. Guaranteed. Write for catalog on Ross, the most complete line ever made by one manufacturer, over 1600 items including transformers, chokes, filter condensers, steel transmitter frames, racks, towers, masts, etc. L. I. Marine & Electric Co., 163-18 Jamaica Ave., Jamaica, N. Y.

CRYSTALS, 1", x or y, 80-60. Prompt service. Guaranteed, \$1.35. W9HWE.

TRANSFORMERS—quotations given. Frank Greben, W9CES, Accurate Radio Service, 2920 W. Cermak Rd., Chicago, Ill. Phone Crawford 2050.

1000 W transformers (GE) 1100-2200-4400 Volts each side centertap. Same as hundreds sold A.R.R.L. members. Dawson, 5740 Woodrow, Detroit, Mich.

866s, 1000 hour guarantee, \$1.49. See March "Ham-Ad." List 2¢, Howard Radio, 314 Pine Ave., Chicago.

QSLs! Finest obtainable! W6FZQ, Box 1804, Phoenix, Ariz.

XTALS to trade for meters, etc. W4KP, Tarrant, Ala.

QSLs! Snappy! Bright! Different! 200 two colors, \$1. Samples! Service! W5AUB, 410 Green, Tupelo, Miss.

CALLBOOKS—new Spring 1934 Radio Amateur Call Book, many pages of new W calls added and hundreds of new DX stations, is yours for \$1.10. Next four issues for \$3.65 (Foreign \$1.20 and \$3.90). W9F0-610 S. Dearborn, Chicago.

QSLs, complete file from December 1915 to December 1930. Make offer. Bates Radio, 274 Main St., Worcester, Mass.

CRYSTALS 95¢, 160 or 80 meters. Within 10 kc, your specified frequency. Kleber heavy duty 866s, guaranteed 1000 hours, \$1.49. 866 filament transformers, 15,000 volt mica insulation, \$2.25. Write for Taylor tube circular. Kleber Radio Labs., W9IOE, Belvidere, Ill.

QSLs, SWLs, W6DOU. Hayward, Calif.

WANTED—meters, testing equipment, Weston, Jewell, Day-Rad or Supreme analyzer, tube tester, metal working tools and machinery, microscope, for cash or trade. Xmitting apparatus and SW receiver (complete station) including wavemeters. F. G. Carr, 75 Summer St., Lancaster, N. E. W1CE.

## PROFIT BY THE EXPERIENCE OF OTHERS—Thousands of Amateurs Have Read HINTS AND KINKS

If you haven't yet gotten a copy of this indispensable compilation of the money-saving ideas of 189 experimenters, you'll be glad to know that the original supply, exhausted in less than six months, has been replenished by a second printing. You'll find in it hundreds of good ideas which amateurs have found helpful. It will return its cost many times in money savings — and it will save hours of time. Many of these little dodges would probably never occur to you. Order your copy at once.

## HINTS AND KINKS FOR THE RADIO AMATEUR

No. 10 in the A.R.R.L. series entitled The Radio Amateur's Library

EIGHTY PAGES IN ATTRACTIVE PAPER COVERS  
50 cents, postpaid anywhere (no stamps, please)

THE AMERICAN RADIO RELAY LEAGUE  
West Hartford, Connecticut

## QST Oscillating Crystals

"SUPERIOR BY COMPARISON"

All "Scientific Radio Service Crystals" are accurately ground to an accuracy better than .03% on equipment tested regularly by the U. S. Bureau of Standards standard frequency signals.

### BROADCAST and COMMERCIAL BANDS

Broadcast Band Crystals mounted in our Standard Holder and ground to our usual high degree of accuracy now \$35.00 each. Mounted in our NEW Isolantite Monel Metal Crystal Holder \$45.00 (adjustable air gap). Prices for other Frequency Bands quoted upon application.

### AMATEUR BAND

Scientific Radio Service Crystals ground to within FIVE Kilo-cycles of your specified frequency in either 80 or 160 meter bands \$15.00 each. Mounted in our Standard Holder \$5.00 additional. Accurate calibration with each crystal.

### PROMPT SHIPMENTS ASSURED

## Scientific Radio Service



"The Crystal Specialists" Since 1925

124 Jackson Ave., University Park  
Hyattsville, Maryland Dept. Q-4



### RK-18

First in performance and efficiency among RF amplifiers, oscillators and modulators of its class. . . . . \$10.95

### RK-17

The right pentode for the Tri-Tet Circuit. . . . . \$5.00

### RK-19

A new High Vacuum, Full Wave Rectifier for Noiseless Power supply at 1000 V. DC. . . . . \$7.50

### R-866 A

New in Design — and at a new price. . . . . \$5.00

Prices are net to the Amateur

Write for Technical data

## RAYTHEON PRODUCTION CORPORATION

30 E. 42nd Street, New York, N. Y.

San Francisco — Chicago — Newton, Mass.

# Your Nearest Dealer

Your nearest dealer is entitled to your patronage. You can trust him. He is equipped with a knowledge and understanding of amateur radio. He is your logical and safe source of advice and counsel on what equipment

Patronize the dealer nearest you—

<p><b>ALLENTOWN, PENNSYLVANIA</b> Radio Electric Service Co. 1024 Hamilton Street Complete stocks transmitting equipment</p>	<p><b>CLEVELAND, OHIO</b> Radio Servicemen's Supply Co. 206 Prospect Street Wholesale Distributors catering to Amateurs, Dealers, Servicemen</p>
<p><b>BALTIMORE, MARYLAND</b> Radio Electric Service Co. 303 W. Baltimore Street Everything for the amateur</p>	<p><b>DENVER, COLORADO</b> Inter-State Radio &amp; Supply Co. 1639 Tremont Place Amateur Radio Headquarters in the Rocky Mountain Region</p>
<p><b>BOSTON, MASSACHUSETTS</b> Nutter &amp; Cross, Inc. 99A Milk Street All OMs, OWs, and YLs welcome — W1HRF</p>	<p><b>DETROIT, MICHIGAN</b> Radio Equipment Sales Co. 14036 Woodward Avenue, Highland Park A complete stock of amateur, shortwave and service parts</p>
<p><b>BROCKTON, MASSACHUSETTS</b> Ware Radio Supply Company 913 Centre Street Everything in parts. Comet Pro in stock with crystal filter</p>	<p><b>DETROIT, MICHIGAN</b> Radio Specialties Company 171 E. Jefferson Avenue Ham Supplies — National &amp; Hammarlund Sets and Parts</p>
<p><b>BUFFALO, NEW YORK</b> Dymac Radio 359 Capen Blvd. — Tel. Univ. 9380 Complete Stock Amateur Parts — Standard Discounts — W8AWK</p>	<p><b>ERIE, PENNSYLVANIA</b> Jordan Radio Laboratory 1019 East Fifth Street Amateur, service parts, including Bliley, National, Raytheon. W8CXG</p>
<p><b>BUFFALO, NEW YORK</b> Kronson Service Company 143 East Genesee Street Western New York's largest wholesale distributors — W8EHF</p>	<p><b>HOUSTON, TEXAS</b> Straus-Frank Company Distributors for nationally advertised amateur products RCA-DeForest transmitting tubes</p>
<p><b>CHICAGO, ILLINOIS</b>  Chicago Radio Apparatus Company 415 South Dearborn Street  Dependable Radio Equipment. Established 1921. All Standard Lines</p>	<p><b>KANSAS CITY, MISSOURI</b> Burstein-Applebee Company 1012-14 McGee Street "Specialists" in supplies for the Amateur and Serviceman</p>
<p><b>CHICAGO, ILLINOIS</b> Mid-West Radio Mart 520 S. State Street All standard lines carried in stock</p>	<p><b>KANSAS CITY, MISSOURI</b> Radio Laboratories 1515 Grand Avenue Amateur Headquarters — Complete Stock — Quality Parts</p>
<p><b>CHICAGO, ILLINOIS</b>  Newark Electric Company 226 W. Madison Street  Chicago's oldest radio parts store — established 1921 John T. Wallace, Technical Adviser</p>	<p><b>LOS ANGELES, CALIFORNIA</b> Radio Manufacturers Supply Co., Inc. 1000 S. Broadway Amateur Headquarters of the Pacific Coast</p>
<p><b>CLEVELAND, OHIO</b> Northern Ohio Laboratories 2073 West 85 Street Wholesale Distr. for National, Hammarlund, Thordarson, Cardwell</p>	<p><b>MANCHESTER, NEW HAMPSHIRE</b> Radio Service Lab. of N. H. 1008 Elm Street — Tel. 218-W Branches — Portland, Me. and Barre, Vt.</p>
	<p><b>MILWAUKEE, WISCONSIN</b> Radio Parts Company, Inc. 332 West State Street Complete stock Nationally Known products</p>
	<p><b>NEWARK, NEW JERSEY</b> Kaltman &amp; Romander 62 Court Street Drop in for an over-counter QSO</p>

This advertisement is paid for by the firms listed above. Qualified dealers



# You Are Protected When You Buy From QST Advertisers

¶ "Advertising for QST is accepted only from firms who, in the publisher's opinion, are of established integrity and whose products secure the approval of the technical staff of the American Radio Relay League."

Quoted from QST's advertising rate card.

Every conceivable need of a radio amateur can be supplied by the advertisers in QST. And you will know the product has the approval of the League's technical staff.

For Your Convenience

## QST'S INDEX OF ADVERTISERS IN THIS ISSUE

American Machine & Tool Co. ....	73
A.R.R.L. Application Blank. ....	74
Back Copies. ....	80
Binders. ....	76
Handbook. ....	88, <i>Cov. II</i>
Hints & Kinks. ....	91
How to Become a Radio Amateur. ....	89
License Manual. ....	87
Supplies. ....	84
Bellefonte Radio Engineering Labs. ....	86
Birnback Radio Company. ....	86
Blan, the Radio Man, Inc. ....	73
Bliley Piezo-Electric Co. ....	79
Burgess Battery Company. ....	96
Cameradio Company. ....	77
Candler System Company. ....	87
Capitol Radio Engineering Institute. ....	75
Cardwell Mfg. Corp., Allen D. ....	1
Central Radio Labs. ....	86
Collins Radio Company. ....	6, 7
Commercial Radio. ....	82
Cornell-Dubilier Corp. ....	83
Delaware Radio Sales Co. ....	81
Delta Mfg. Company. ....	78
Dodge's Institute. ....	84
Electrad, Inc. ....	89
Emery, A. H. ....	83
General Electric Co. ....	71
General Radio Company. ....	73
Gross Radio Co. ....	64, 65
Gulf Radio School. ....	82
Hammarlund Mfg. Company. ....	4
Harvey Radio Labs. ....	75
Hatry & Young. ....	85
Heintz & Kaufman, Ltd. ....	88
Hygrade Sylvania Corp. ....	95
Instructograph Co. ....	75
Jappe Co., H. ....	79
Kaltman & Romander. ....	70
Kenyon Transformer Co. ....	67
Klaus Radio & Elec. Co. ....	89
Leeds. ....	69
Littelfuse Labs. ....	87
Lynch Mfg. Company. ....	84
M & H Sporting Goods Co. ....	83
Massachusetts Radio School. ....	83
National Carbon Company. ....	77
National Company. ....	63, 78, 84, <i>Cov. III</i>
New York Y.M.C.A. Schools. ....	79
Port Arthur College. ....	73
Precision Piezo Service. ....	83
Radio Electric Service Co. ....	72
Radio Laboratories. ....	77
Radio Supply Co. ....	87
Raytheon Production Corp. ....	91
RCA Institutes, Inc. ....	87
RCA Radiotron Co., Inc. ....	<i>Cov. IV</i>
Ross & Co., A. H. ....	81
Sangamo Electric Co. ....	89
Schwartz & Son, Maurice. ....	84
Scientific Radio Service. ....	91
Teleplex Company. ....	82
Trimm Radio Mfg. Co. ....	84
United Radio Mfg. Co. ....	75
Universal Microphone Lab. ....	77
University of Wisconsin. ....	89
Ward Leonard Electric Co. ....	81
Westinghouse Electric & Mfg. Co. ....	2
Weston Electrical Instrument Corp. ....	66
Wing's Sons, Chauncey. ....	79



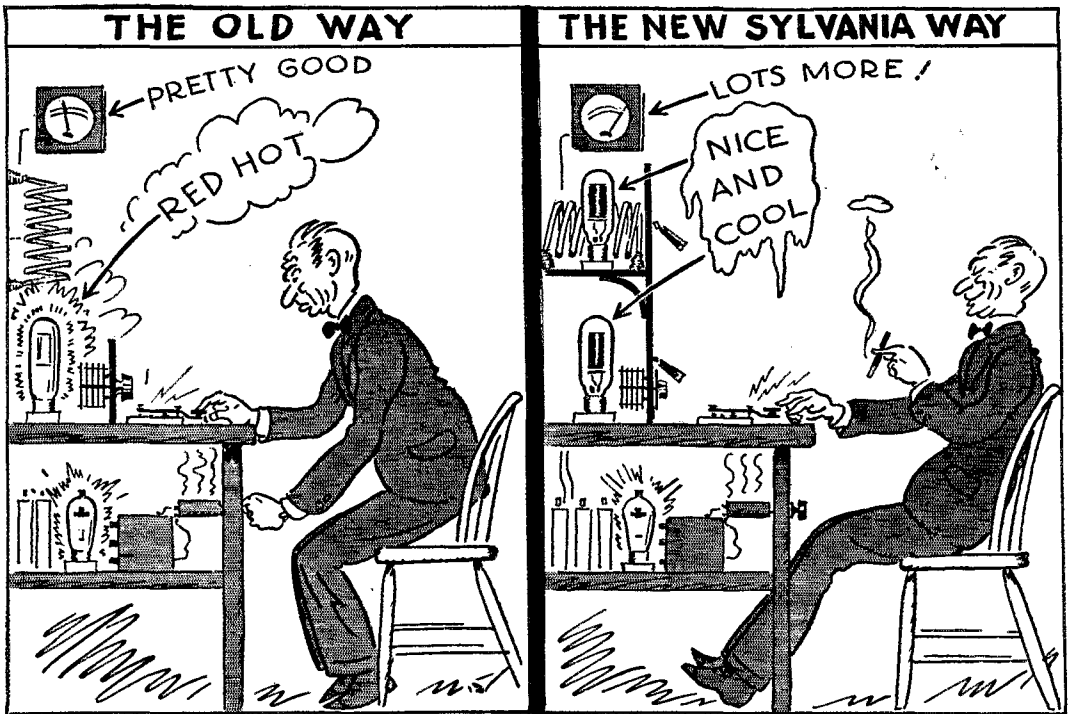

# *Sylvania* Graphite Anode Tubes run Cool yet Dissipate Greater Power

**A**MATEURS the country over, yes, even the world over are acclaiming SYLVANIA GRAPHITE ANODE TUBES. They run "cool as cucumbers"... no red-hot plates... yet they put more power into the antenna without your having to "push" them. What this all means is that you get more power output with the same plate power you have been using, and with a greatly lengthened tube life. In a nut shell, improved performance... lower cost.

Every SYLVANIA air-cooled transmitting tube

uses the GRAPHITE ANODE construction. Do not confuse SYLVANIA GRAPHITE ANODE tubes with the garden variety of carbon plate tubes. There is a distinct difference. SYLVANIA GRAPHITE ANODES receive a special treatment which eliminates the possibility of amorphous carbon and hydro-carbons being scattered on the grid, filament, press and spacers during bombardment. Sylvania transmitting tubes receive a very thorough and exacting exhaust which brings them mighty close to a "perfect" vacuum.

## HYGRADE SYLVANIA CORPORATION

ELECTRONICS DEPARTMENT

AMATEUR RADIO DIVISION

CLIFTON, NEW JERSEY

FACTORIES:

Salem, Mass.

Emporium, Pa.

St. Marys, Pa.

Clifton, N. J.



© 1934, H. S. C.

Say You Saw It in QST — It Identifies You and Helps QST

95

# BURGESS

*... first choice*

of Great Explorers  
and Successful "Hams"



ELLSWORTH  
USES BURGESS

## When it's a Matter of Life and Death...

When you're flying somewhere in the Antarctic wastes, thousands of miles from civilization, it's mighty important to keep in touch with your supply ship. And it's mighty comforting to look at your black and white striped radio batteries—and KNOW they're dependable! ● If you were down near the South Pole with that famous explorer, Lincoln Ellsworth, on his Trans-Antarctic Flight Expedition, you would know how important it is to have dependable batteries—and you would know why Ellsworth uses BURGESS. ● Great Explorers—and successful "Hams"—choose BURGESS. Both know, by experience, that "there is more battery in every BURGESS."



**BURGESS BATTERY COMPANY**  
FREEPORT, ILLINOIS

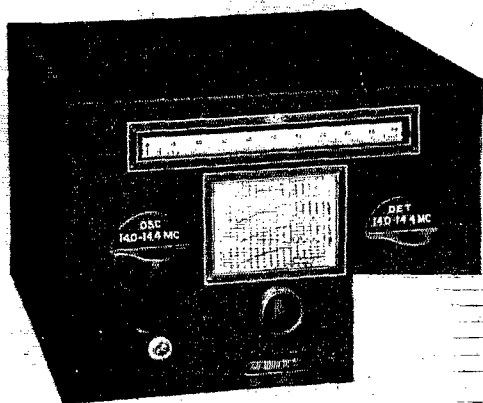

# FB-7 -X

## Calibrated Band-Spread

Technically, Band-Spreading is merely a device to spread stations farther apart on the dial. To National it is more than this, it is an electrical vernier for precise logging as well as for swift tuning. • For within each band-spread coil is built every band spread element, handled as a unit and calibrated as a unit. Difficult? Yes. Expensive? We admit it. But only in this way can National's conception of Band-Spreading be achieved; only thus can permanent, accurate and reliable single-control calibration be obtained.



**NATIONAL COMPANY, INC., MALDEN, MASS.**

# NEW HELPS IN BUILDING THE PERFECT AMATEUR STATION

## RCA CATHODE-RAY TUBES

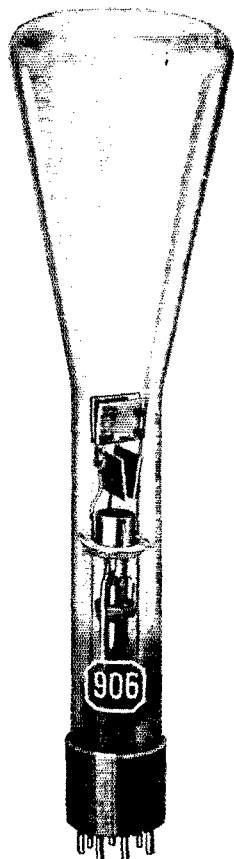

RCA-906—3 inch screen.  
Electro - static deflection.  
Amateurs' Net Price . . . **\$18.00**

RCA-905—5 inch screen.  
Electro - static deflection.  
Amateurs' Net Price . . . **\$40.00**

RCA 904—5 inch screen.  
Electro - static - magnetic deflection. Amateurs' Net Price . . . **\$50.00**

of the hot-cathode, high-vacuum type. These tubes provide a brilliant, luminous spot capable of showing high-frequency phenomena. RCA-878 and RCA-885 are new tubes for use with the cathode-ray tubes.

The cathode-ray tube will find numerous applications in the amateur station. Useful as oscilloscopes, modulation indicators, and in lining up amplifier and oscillator stages, RCA deForest Cathode-Ray Tubes offer the amateur a new tool for perfecting the technical excellence of his station.

For a number of years the laboratory of the RCA Radiotron Company has been engaged in an extensive research and development program on cathode-ray tubes. Involving an unusual amount of production experience on cathode-ray types, this program has emphasized the same thorough and painstaking attention to detail that characterizes the development of all RCA types.

The results of this work are now made available in four cathode-ray tubes. These are supplemented by two types—one a rectifier for high-voltage supply, and the other a triode, gaseous type, for sweep-circuit operation. These designs have been carefully chosen to meet the diversified needs of oscillograph application.

### IMPORTANT FEATURES

1. **QUALITY.** RCA Cathode-Ray Tubes are manufactured to laboratory standards of precision. Comprehensive tests have demonstrated their excellent life performance.

2. **AVAILABILITY FOR RENEWAL.** The RCA Monogram is your assurance that these designs are standardized and will be available when required for renewal purposes.

### FOR USE WITH CATHODE-RAY TUBES



RCA-878—A high-voltage, high-vacuum rectifier.  
Amateurs' Net Price **\$11.00**



RCA-885—A gaseous-type triode, suitable for sweep-circuit control.  
Amateurs' Net Price **\$2.00**

For additional information see your RCA deForest Distributor or write to

**RCA de Forest** AMATEUR RADIO DIVISION  
**RCA RADIOTRON CO., INC.**  
 CAMDEN NEW JERSEY